



KNOR

SB5 - SN5 Series	02
SB6 - SN7 Series	19
SN6 - SN7 - SK7 Series	44
SL7 - SM7 series	64

MERITOR

D3 Series	67
DUCO Series	79
DX 195 Series	92
ELSA-1 Series	102
ELSA-2195-225 Series	116
LISA Series	154

WABCO

WBC 10" , 17.5" Series	140
WBC 17.5" Series	144
WBC 19.5"-22.5" (Single Piston) Series	151
WBC 19.5"-22.5" (Double Piston) Series	159

HALDEX

Haldex Series	164
---------------	-----

Z-CAM

Z-Cam Series	183
--------------	-----

IVECO

Ø 410 Simplex Grubu	193
---------------------	-----

Ø 410 Simplex Kit Grubu	198
-------------------------	-----

Ø 410 Duplex Grubu	201
--------------------	-----

Ø 410 Duplex Kit Grubu	206
------------------------	-----

Ø 410 Perrot Grubu	208
--------------------	-----

Ø 410 Perrot Kit Grubu	212
------------------------	-----

Ø 360 Perrot Grubu	214
--------------------	-----

Ø 360 Perrot Kit Grubu	218
------------------------	-----

Ø 360 Duplex Grubu	220
--------------------	-----

Ø 360 Duplex Kit Grubu	223
------------------------	-----

Ø 381 - 394 Duplex Grubu	224
--------------------------	-----

IVECO

Ø 381 - 394 Duplex Kit Grubu

230

SAF

Saf

232

KNOR

KNOR

421103

SB5 - SN5 series

Kaliper Toz Lastığı Tamir Takımı (Ø 69 mm) / Caliper Tappet & Boot Kit (Ø 69 mm)

Orjinal No:

Cross No :

S.No.	Ekarsan No.	Ürün Tanımı / Description	Ölçü/Dimension	Miktar/Qt
1	423001	Pabuçla Lastik / Trust Part With Bellow	Ø 69,00 mm	1
2	423002	Toz Lastığı / Shaft Body Dust Rubber	Ø 69,00 mm	1
3	426001	Metal Burç / Tappet Bush	Ø 18x16x18 mm	1



Tip / Application

ALL SB5..., SN5..., SERIES

KNOR

421109

SB5 - SN5 series

Toz Lastığı Tamir Takımı / Caliper Tappet & Boot Kit (Ø 74 mm)

Orjinal No: 421109

Cross No : 301762845

S.No.	Ekarsan No.	Ürün Tanımı / Description	Ölçü/Dimension	Miktar/Qt
1	423003	Pabuçla Lastik / Trust Part With Bellow	Ø 74,00 mm	1
2	423004	Toz Lastığı / Shaft Body Dust Rubber	Ø 74,00 mm	1
3	426001	Metal Burç / Tappet Bush	Ø 18x16x18 mm	1



Tip / Application

ALL SB5..., SN5..., SERIES

KNOR

421112

SB5 - SN5 series

Kaliper Toz Lastığı Tamir Takımı (Ø 69 mm) / Caliper Tappet & Boot Kit (Ø 69 mm)

Orjinal No: 60588226007

Cross No : 8801929

S.No.	Ekarsan No.	Ürün Tanımı / Description	Ölçü/Dimension	Miktar/Qt
1	423009	Pabuçla Lastik / Trust Part With Bellow	Ø 69,00 mm	1
2	423002	Toz Lastığı / Shaft Body Dust Rubber	Ø 69,00 mm	1
3	426001	Metal Burç / Tappet Bush	Ø 18x16x18 mm	1



Tip / Application

ALL SB5..., SN5..., SERIES

KNOR

421113

SB5 - SN5 series



p / Application

Kaliper Toz Lastığı Tamir Takımı (Ø 69 mm) / Caliper Tappet & Boot Kit (Ø 69 mm)

Orjinal No:

Cross No :

S.No.	Ekersan No.	Ürün Tanıtımı / Description	Ölçü/Dimension	Miktar/Qt.
1	423009	Pabuçlu Lastik / Trust Part With Bellow	Ø 69,00 mm	1
2	426001	Metal Barç / Tappet Bush	Ø 18x16x10 mm	1

KNOR

421128

SB5 - SN5 series



p / Application

LL SB..., SN..., SK..., SERIES

Kaliper Mekanizması Bilyalı / Caliper Adjusting Mechanism Shaft

Orjinal No:

Cross No :

S.No.	Ekersan No.	Ürün Tanıtımı / Description	Ölçü/Dimension	Miktar/Qt.
1	421128	Kaliper Mekanizması / Caliper Adjusting Mechanism Shaft		1

KNOR

421138

SB5 - SN5 series

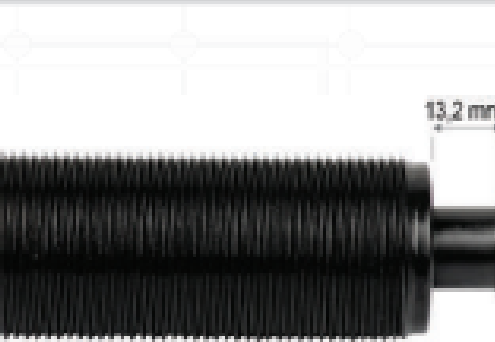

Kaliper Ayar Civatası / Caliper Calibration Bolt

Orjinal No:

Cross No :

S.No.	Ekersan No.	Ürün Tanıtımı / Description	Ölçü/Dimension	Miktar/Qt.
1	421138	Kaliper Ayar Civatası / Caliper Calibration Bolt		1

KNOR

421140

SB5 - SN5 series

Kaliper Mekanizması / Adjusting Mechanism Shaft

Orjinal No:

Cross No :

S.No.	Ekersan No.	Ürün Tanımı / Description	Ölçü/Dimension	Miktar/Qt
1	421140	Kaliper Mekanizması / Adjusting Mechanism Shaft		1



Tip / Application

ALL SN5... SERIES

KNOR

421141

SB5 - SN5 series

Mekanizma Zinciri / Caliper Calibration Shaft Chain (14 Links)

Orjinal No:

Cross No :

S.No.	Ekersan No.	Ürün Tanımı / Description	Ölçü/Dimension	Miktar/Qt
1	421141	Mekanizma Zinciri / Caliper Calibration Shaft Chain (14 Links)	14 tane / Link	1



Tip / Application

ALL SB5... SN5... SERIES

KNOR

421143

SB5 - SN5 series

Kaliper Ayar Dişlisi / Caliper Adjusting Shaft

Orjinal No:

Cross No :

S.No.	Ekersan No.	Ürün Tanımı / Description	Ölçü/Dimension	Miktar/Qt
1	421143	Kaliper Ayar Dişlisi / Caliper Adjusting Shaft		1

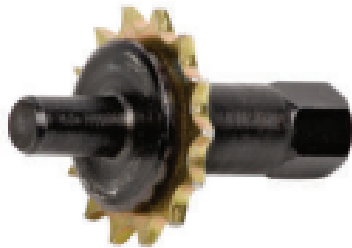

Tip / Application

ALL SN5... SERIES

KNOR

421144

Kaliper Dürbün Takımı / Caliper Adjustment Carrier

SB5 - SN5 series

Orjinal No:

Cross No :



S.No.	Ekensan No.	Ürün Tanıtımı / Description	Ölçü/Dimension	Miktar/Qty.
1	421144	Kaliper Dürbünü / Caliper Bridge Assembly		1
2	427002	Yay Yatağı / Spring Housing		2

Tip / Application

ALL SB5..., SN5..., SERIES

KNOR

421145

Kaliper Dürbün Takımı / Caliper Adjustment Carrier

SB5 - SN5 series

Orjinal No:

Cross No :



S.No.	Ekensan No.	Ürün Tanıtımı / Description	Ölçü/Dimension	Miktar/Qty.
1	421145	Kaliper Dürbünü / Caliper Bridge Assembly		1
2	427002	Yay Yatağı / Spring Housing		2

Tip / Application

ALL SB5..., SN5..., SERIES

KNOR

421146

Kaliper Masura Bilya Takımı / Caliper Roller Bearing Set

SB5 - SN5 series

Orjinal No:

Cross No :



S.No.	Ekensan No.	Ürün Tanıtımı / Description	Ölçü/Dimension	Miktar/Qty.
1	423546	Kaliper Masura Bilya / Caliper Roller Bearing		1

Tip / Application

ALL SN5..., SN6..., SN7..., SN7..., SERIES

KNOR

421147

Kaliper Masura Bilya Takımı / Caliper Roller Bearing Set

SB5 - SN5 series

Orjinal No:

Cross No :



S.No.	Ekensan No.	Ürün Tanıtımı / Description	Ölçü/Dimension	Miktar/Quantity
1	421147	Kaliper Masura Bilya / Caliper Roller Bearing		2

Tip / Application

ALL SB5..., SB6..., SB7..., SM6..., SN7..., SK7... SERIES

KNOR

421154

Kaliper Perno Tamir Takımı / Caliper Pin Repair Kit

SB5 - SN5 series

Orjinal No: 000420282 / 81508218005 / 1390421 / 93182048 / 1035585 / 1042142 / 1188263 / 1206154 / 1448913

Cross No : "328890862339688963369188062"



S.No.	Ekensan No.	Ürün Tanıtımı / Description	Ölçü/Dimension	Miktar/Quantity
1	424005	Kaliper Perno / Caliper Bolt	Ø 34x88 mm	1
2	425001	Kaliper Vidası / Caliper Screw	M16x1,5x85 mm	1
3	425002	Kaliper Vidası / Caliper Screw	M16x1,5x150 mm	1
4	423005	Körük (Kırmızı) / Bellow (Red)		1
5	428002	Fiber O-ring / Fiber O-Ring	Ø 34xØ58 mm	1
6	423006	Körük (Siyah) / Bellow (Black)		1
7	429001	Perno Tapası / Bolt Plug	Ø 58x28 mm	1
8	426002	Metal Burç / Caliper Pin Bush (Yellow)	Ø 36xØ82 mm	1
9	423007	Plastik Burç / Plastic Bushing		1
10	424001	Kaliper Perno / Caliper Bolt	Ø 36x145 mm	1

Tip / Application

ALL SB5..., SB6..., SB7... SERIES

KNOR

421158

Kaliper Perno Tamir Takımı / Caliper Pin Repair Kit

SB5 - SN5 series

Orjinal No: 343080000 / 1448913

Cross No : 36847864



S.No.	Ekensan No.	Ürün Tanıtımı / Description	Ölçü/Dimension	Miktar/Quantity
1	425001	Kaliper Vidası / Caliper Screw	M16x1,5x85 mm	1
2	423007	Plastik Burç / Plastic Bushing		1
3	424005	Kaliper Perno / Caliper Bolt	Ø 34x88 mm	1

SAF / DA

421162

Kaliper Körük Takımı / Caliper Bellow Set

SB5 - SN5 series

Orjinal No:

Cross No :



S.No.	Ekersan No.	Ürün Tanıtımı / Description	Ölçü/Dimension	Miktar/Qty.
1	420002	Fiber O-ring / Fiber O-Ring	Ø 34xØx30 mm	1
2	423005	Körük (Kırmız) / Bellow (Red)		1

Tip / Application

ALL SB5..., SB6..., SB7..., SERIES

421168

Kaliper Perno Tamir Takımı / Caliper Pin Repair Kit

SB5 - SN5 series

Orjinal No: 0360189300 / 3424081300

Cross No : K080698



S.No.	Ekersan No.	Ürün Tanıtımı / Description	Ölçü/Dimension	Miktar/Qty.
1	425001	Kaliper Vidası / Caliper Screw	M16x1,5x80 mm	1
2	421182	Lastik Barç (Uzun) / Caliper Pin Rubber Bush (Long)	Ø 39xØx73 mm	1
3	429003	Perno Yüzüğü / Caliper Bolt Ring	Ø 26,5x11 mm	1
4	424004	Kaliper Pernosu / Caliper Bolt	Ø 32x80 mm	1

Tip / Application

ALL SB5..., SB6..., SB7..., SN6..., SN7..., SK7..., SERIES

421171

Kaliper Perno Tamir Takımı / Caliper Pin Repair Kit

SB5 - SN5 series

Orjinal No:

Cross No : K081938



S.No.	Ekersan No.	Ürün Tanıtımı / Description	Ölçü/Dimension	Miktar/Qty.
1	424007	Kaliper Pernosu / Caliper Bolt	Ø 30x99 mm	1
2	424008	Kaliper Pernosu / Caliper Bolt	Ø 38x72 mm	1
3	425006	Kaliper Vidası / Caliper Screw	M16x1,5x105 mm	1
4	425007	Kaliper Vidası / Caliper Screw	M16x1,5x75 mm	1
5	423010	Körük (Kırmız) / Bellow (Red)		2
6	426003	Head Barç / Bushing	Ø 34x30x5 mm	1
7	426004	Head Barç / Head Bushing	Ø 30x34x20 mm	1
8	429005	Perno Tapası / Bolt Plug	Ø 34x14 mm	2
9	423010	Plastik Yüzük / Plastic Ring		2

Tip / Application

ALL SN5..., SERIES

421174

Kaliper Perno Kapak Takımı / Caliper Pin Cap Set

SB5 - SN5 series

Orjinal No: 02084226025

Cross No : 8801381



S.No.	Ekersan No.	Ürün Tanıtımı / Description	Ölçü/Dimension	Miktar/Qty.
1	428001	Kaleçe / Clamp	Ø 14xØ60 mm	6
2	429001	Perno Tapası / Bolt Plug	Ø 58x28 mm	6
3	428003	O-ring / O-Ring		6
4	423006	Körük (Siyah) / Bellow (Black)		6

Tip / Application

ALL SB..., SN..., SERIES

421175

Kaliper Ayar Mekanizması Kapak Takımı / Caliper Adjusting Mechanism Cap Set

SB5 - SN5 series

Orjinal No: 0004234607 / 01500220021

Cross No : 8800829



S.No.	Ekersan No.	Ürün Tanıtımı / Description	Ölçü/Dimension	Miktar/Qty.
1	421149	Mekanizma Ayar Somunu / Adjusting Nut		10
2	423011	Plastik Kapak / Plastic Cover	Ø 38 mm	10

Tip / Application

ALL SB5..., SN5..., SB6..., SB7..., SN6..., SN7..., SK7..., SERIES

421176

Kaliper Ayar Mekanizması Kapak Takımı / Caliper Adjusting Mechanism Cap Set

SB5 - SN5 series

Orjinal No:

Cross No : 8803912



S.No.	Ekersan No.	Ürün Tanıtımı / Description	Ölçü/Dimension	Miktar/Qty.
1	421149	Mekanizma Ayar Somunu / Adjusting Nut		10
2	423012	Plastik Kapak / Plastic Cover	Ø 35 mm	10

Tip / Application

ALL SB5..., SN5..., SB6..., SB7..., SN6..., SN7..., SK7..., SERIES

KNOR

421185

Mekanizma Zinciri / Caliper Calibration Shaft Chain (12 Links)

SB5 - SN5 series

Orjinal No:

Cross No :

S.No.	Ekresan No.	Ürün Tanıtımı / Description	Ölçü/Dimension	Miktar/Qty.
1	421185	Mekanizma Zinciri / Caliper Calibration Shaft Chain (12 Links)	12 tane / Links	1

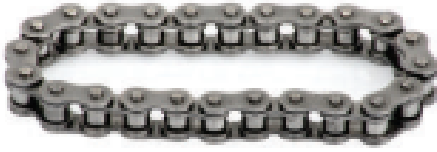

Tip / Application

ALL SB5... SERIES

KNOR

421187

Kaliper Masura Bilya Yatagi / Caliper Lever

SB5 - SN5 series

Orjinal No:

Cross No :

S.No.	Ekresan No.	Ürün Tanıtımı / Description	Ölçü/Dimension	Miktar/Qty.
1	421187	Kaliper Masura Bilya Yatagi / Caliper Lever		1



Tip / Application

ALL SN5... SERIES

KNOR

421189

Kaliper Ayar Dislisi / Caliper Adjusting Shaft

SB5 - SN5 series

Orjinal No:

Cross No :

S.No.	Ekresan No.	Ürün Tanıtımı / Description	Ölçü/Dimension	Miktar/Qty.
1	421189	Kaliper Ayar Dislisi / Caliper Adjusting Shaft		1



Tip / Application

ALL SN5... SERIES

KNOR

421190

Kaliper Masura Bilya Takımı / Caliper Roller Bearing Set

SB5 - SN5 series

Orjinal No:

Cross No :



S.No.	Ekersan No.	Ürün Tanıtımı / Description	Ölçü/Dimension	Miktar/Qty.
1	421190	Kaliper Masura Bilya / Caliper Roller Bearing		2

Tip / Application

ALL SB5..., SN5..., SERIES

KNOR

421191

Kaliper Perno & Lastikli Burç (Uzun) / Caliper Pin & Bush (Long)

SB5 - SN5 series

Orjinal No:

Cross No : K88067

Ø 39 mm



Ø 32 x 80 mm



S.No.	Ekersan No.	Ürün Tanıtımı / Description	Ölçü/Dimension	Miktar/Qty.
1	421182	Lastikli Burç (Uzun) / Caliper Pin Rubber Bush (Long)	Ø 39x80x73 mm	1
2	424004	Kaliper Perno / Caliper Bolt	Ø 32x80 mm	1

Tip / Application

ALL SB5..., SN5..., SB6..., SB7..., SN6..., SN7..., SK7..., SERIES

KNOR

421192

Kaliper Ayar Mekanizması Kapak Takımı / Caliper Adjusting Mechanism Cap Set

SB5 - SN5 series

Orjinal No: 82508228024

Cross No : K88045



38 mm

S.No.	Ekersan No.	Ürün Tanıtımı / Description	Ölçü/Dimension	Miktar/Qty.
1	421149	Mekanizma Ayar Somunu / Adjusting Nut		10
2	428037	Kaliper Keçesi / Caliper Seal		10
3	423011	Plastik Kapak / Plastic Cover	Ø 38 mm	10

Tip / Application

ALL SB5..., SN5..., SB6..., SB7..., SN6..., SN7..., SK7..., SERIES

MAN

KNOR

421193

Kaliper Perno Tamir Takımı / Caliper Pin Repair Kit

SB5 - SN5 series

Orjinal No:

Cross No :



S.No.	Ekersan No.	Ürün Tanıtımı / Description	Ölçü/Dimension	Miktar/Qty.
1	423007	Plastik Burç / Plastic Bushing		1
2	424005	Kaliper Perno / Caliper Bolt	Ø 34x80 mm	1

Tip / Application

ALL SB5..., SB6..., SB7..., SERIES

KNOR

421194

Kaliper Perno & Lastikli Burç (Uzun) / Caliper Pin & Bush (Long)

SB5 - SN5 series

Orjinal No:

Cross No :



S.No.	Ekersan No.	Ürün Tanıtımı / Description	Ölçü/Dimension	Miktar/Qty.
1	421252	Lastikli Burç (Uzun) / Caliper Pin Rubber Bush (Long)	Ø 35x48x73 mm	1
2	424004	Kaliper Perno / Caliper Bolt	Ø 32x80 mm	1

Tip / Application

ALL SB5..., SN5..., SB6..., SB7..., SERIES

KNOR

421195

Mekanizma Ayar Somunu Seti / Adjusting Nut - Set

SB5 - SN5 series

Orjinal No:

Cross No : 3801548



S.No.	Ekersan No.	Ürün Tanıtımı / Description	Ölçü/Dimension	Miktar/Qty.
1	421195	Mekanizma Ayar Somunu / Adjusting Nut		10

Tip / Application

ALL SB..., SN..., SK..., SERIES

421196

SB5 - SN5 series

Balata Tutucu & Ayar Somun Takımı / Pad Retainer & Mechanism Adapter Kit

Original No:

Cross No :



S.No.	Ekersan No.	Ürün Tanımı / Description	Ölçü/Dimension	Miktar/Qty.
1	421149	Mekanizma Ayar Somunu / Adjusting Nut		1
2	422004	Pin / Pin		2
3	428004	Pul / Washer		2
4	428005	Kapıya / Cotter Pin		2
5	426060	Disk Balata Yay / Brake Pad Spring		2
6	423012	Plastik Kapak / Plastic Cover	Ø 35 mm	2

Tip / Application

ALL SB..., SN..., SK..., SERIES

421197

SB5 - SN5 series

Kaliper Perno Tamir Takımı / Caliper Pin Repair Kit

Original No: 0360102000

Cross No :



S.No.	Ekersan No.	Ürün Tanımı / Description	Ölçü/Dimension	Miktar/Qty.
1	429004	Kaliper Videsi / Caliper Screw	M16x1,5x80 mm	1
2	423252	Lastik Bar (Uzun) / Caliper Pin Rubber Bush(Long)	Ø 35x40x73 mm	1
3	429003	Perno Yüzüğü / Caliper Bolt Ring	Ø 26,5x11 mm	1
4	424004	Kaliper Pernosu / Caliper Bolt	Ø 32x80 mm	1

Tip / Application

ALL SB5..., SN5..., SB6..., SB7..., SN6..., SN7..., SK7..., SERIES

421199

SB5 - SN5 series

Kaliper Ayar Mekanizması (Yaysız) / Caliper Adjusting Mechanism (Without Spring)

Original No:

Cross No :

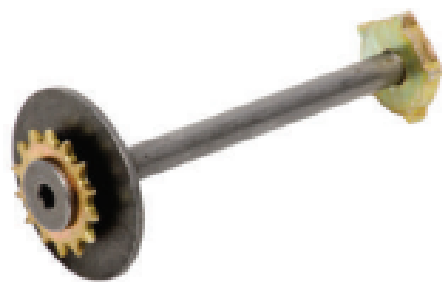

S.No.	Ekersan No.	Ürün Tanımı / Description	Ölçü/Dimension	Miktar/Qty.
1	421299	Ayar Mekanizması Yaysız / Caliper Adjusting Mechanism (Without Spring)		1

Tip / Application

ALL SB5..., SB6..., SB7..., SERIES

KNOR

421202

Kaliper Tapa Seti / Caliper Plug Kits

SB5 - SN5 series

Orjinal No:

Cross No :



S.No.	Ekersan No.	Ürün Tanıtımı / Description	Ölçü/Dimension	Miktar/Qty.
1	421202	Kaliper Tapanı / Caliper Plug		5

Tip / Application

ALL SN5..., SB5..., SB6..., SB7..., SN6..., SN7..., SK7..., SERIES

KNOR

421203

Kaliper Balata Tutucu Tamir Takımı / Caliper Pad Retainer Repair Kit

SB5 - SN5 series

Orjinal No:

Cross No :



S.No.	Ekersan No.	Ürün Tanıtımı / Description	Ölçü/Dimension	Miktar/Qty.
1	423149	Mekanizma Ayar Somunu / Adjusting Nut		1
2	428037	Kaliper Keçesi / Caliper Seal		1
3	428006	Kaliper Tutucu / Brake Pad Retainer		1
4	422004	Pin / Pin		1
5	428004	Pl / Washer		1
6	428005	Koplu / Cotter Pin		1
7	423011	Plastik Kapak / Plastic Cover	Ø 38 mm	2

Tip / Application

ALL SB5..., SN5..., SB6..., SB7..., SN6..., SN7..., SK7..., SERIES

KNOR

421204

Kaliper Toz Lastigi Tamir Takimi (Ø 69 mm) / Caliper Tappet & Boot Kit (Ø 69 mm)

SB5 - SN5 series

Orjinal No:

Cross No :



S.No.	Ekersan No.	Ürün Tanıtımı / Description	Ölçü/Dimension	Miktar/Qty.
1	423009	Pabuç Lastik / Tappet Part With Bellows	Ø 69,00 mm	1
2	423002	Toz Lastigi / Shaft Body Dust Rubber	Ø 69,00 mm	1
3	426001	Metal Buç / Tappet Bush	Ø 18x16x18 mm	1
4	423005	Kirik (Kırmızı) / Bellows (Red)		1
5	423006	Kirik (Siyah) / Bellows (Black)		1
6	428001	Klepe / Clamp	Ø 34x16x58 mm	1
7	423007	Plastik Buç / Plastic Bushing		1
8	428002	Fiber Oring / Fiber O-Ring	Ø 34x16x58 mm	1

Tip / Application

ALL SB5..., SN5..., SERIES

421205

Kaliper Toz Lastiği Tamir Takımı (Ø 74 mm) / Caliper Tappet & Boot Kit (Ø 74 mm)

SB5 - SN5 series

Orjinal No:

Cross No :



S.No.	Ekersan No.	Ürün Tanıtımı / Description	Ölçü/Dimension	Miktar/Qty.
1	423003	Pabuçlu Lastik / Trust Part With Bellow	Ø 74,80 mm	1
2	423004	Toz Lastiği / Shaft Body Dust Rubber	Ø 74,80 mm	1
3	425001	Metal Burç / Tappet Bush	Ø 18x16x10 mm	1
4	423005	Könük (Kırmızı) / Bellow (Red)		1
5	423006	Könük (Siyah) / Bellow (Black)		1
6	428001	Kedepçe / Clamp	Ø 34x40x50 mm	1
7	423007	Plastik Burç / Plastic Bushing		1
8	428002	Fiber O-ring / Fiber O-Ring	Ø 34x40x50 mm	1

Tip / Application

ALL SB5..., SN5..., SERIES

421207

Kaliper Perno Tamir Takımı / Caliper Pin Repair Kit

SB5 - SN5 series

Orjinal No:

Cross No : K881274



S.No.	Ekersan No.	Ürün Tanıtımı / Description	Ölçü/Dimension	Miktar/Qty.
1	424009	Kaliper Pernosu / Caliper Bolt	Ø 36x182 mm	1
2	424004	Kaliper Pernosu / Caliper Bolt	Ø 32x80 mm	1
3	425001	Kaliper Vidası / Caliper Screw	M16x1,5x85 mm	1
4	425004	Kaliper Vidası / Caliper Screw	M16x1,5x80 mm	1
5	423005	Könük (Kırmızı) / Bellow (Red)		1
6	428002	Fiber O-ring / Fiber O-Ring	Ø 34x40x50 mm	1
7	426008	Metal Burç / Bushing	Ø 36x40x71 mm	1
8	421182	Lastikli Burç (Uzun) / Caliper Pin Rubber Bush (Long)	Ø 39x40x73 mm	1
9	429002	Perno Tapası / Bolt Plug	Ø 40x12 mm	1
10	429003	Perno Yüzüğü / Caliper Bolt Ring	Ø 26,5x11 mm	1

Tip / Application

ALL SB5..., SN5..., SERIES

421208

Plastik Kapak Sensörlü / Caliper Plastic Cover With Sensor (2 Lines)

SB5 - SN5 series

Orjinal No:

Cross No :



S.No.	Ekersan No.	Ürün Tanıtımı / Description	Ölçü/Dimension	Miktar/Qty.
1	421208	Plastik Kapak Sensörlü / Caliper Plastic Cover With Sensor (2 Lines)	2 Lines	1

Tip / Application

ALL SN5..., SERIES

KNOR

421209

Plastik Kapak Sensörsüz / Caliper Plastic Cover Without Sensor

SB5 - SN5 series

Orjinal No:

Cross No :



S.No.	Ekersan No.	Ürün Tanıtımı / Description	Ölçü/Dimension	Miktar/Qty.
1	421209	Plastik Kapak Sensörsüz / Caliper Plastic Cover Without Sensor		1

Tip / Application

ALL SN5... SERIES

KNOR

421210

Plastik Kapak Sensörsüz / Caliper Plastic Cover Without Sensor

SB5 - SN5 series

Orjinal No:

Cross No :



S.No.	Ekersan No.	Ürün Tanıtımı / Description	Ölçü/Dimension	Miktar/Qty.
1	421210	Plastik Kapak Sensörsüz / Caliper Plastic Cover Without Sensor		1

Tip / Application

ALL SB5... SERIES

KNOR

421211

Plastik Kapak Sensörlü / Caliper Plastic Cover With Sensor (2 Lines)

SB5 - SN5 series

Orjinal No:

Cross No :



S.No.	Ekersan No.	Ürün Tanıtımı / Description	Ölçü/Dimension	Miktar/Qty.
1	421211	Plastik Kapak Sensörlü / Caliper Plastic Cover With Sensor (2 Lines)	2 Lines	1

Tip / Application

ALL SB5... SERIES

KNOR

421212

Kaliper Kapak Takimi / Caliper Cover Kit

SB5 - SN5 series

Orjinal No:

Cross No :



S.No.	Ekersan No.	Ürün Tanıtımı / Description	Ölçü/Dimension	Miktar/Qty.
1	420053	Kaliper Kapak (Şa) / Caliper Cover (Sheet)		1
2	425022	Kaliper Vidası / Screw	M8x1,25x20 mm	6
3	428036	Kaliper Keçesi / Caliper Seal		1

Tip / Application

ALL SN5... SERIES

KNOR

421213

Kaliper Bilya Destek Seti / Caliper Bearing Support Set

SB5 - SN5 series

Orjinal No:

Cross No :



S.No.	Ekersan No.	Ürün Tanıtımı / Description	Ölçü/Dimension	Miktar/Qty.
1	421213	Bilya Desteg / Bearing Support		5

Tip / Application

ALL SB5... SERIES

KNOR

421214

Kaliper Keçe Seti / Caliper Seal Set

SB5 - SN5 series

Orjinal No:

Cross No :



S.No.	Ekersan No.	Ürün Tanıtımı / Description	Ölçü/Dimension	Miktar/Qty.
1	421214	Kaliper Keçesi / Caliper Seal		5

Tip / Application

ALL SN5... SERIES

KNOR

421249

Kaliper Perno Tamir Takımı / Caliper Pin Repair Kit

SB5 - SN5 series

Orjinal No : 056230538

Cross No : 8801532



Tip / Application

ALL SB..., SN..., SERIES

S.No.	Ekersan No.	Ürün Tanıtımı / Description	Ölçü/Dimension	Miktar/Qty.
1	424004	Kaliper Perno / Caliper Bolt	Ø 32x80 mm	1
2	425001	Kaliper Vidası / Caliper Screw	M16x1,5x85 mm	1
3	425004	Kaliper Vidası / Caliper Screw	M16x1,5x80 mm	1
4	426002	Metal Burç / Caliper Pin Bush (Yellow)	Ø 36x8x82 mm	1
5	421252	Lavülü Burç (Uzun) / Caliper Pin Rubber Bush (Long)	Ø 35x8x73 mm	1
6	423005	Körük (Kırmızı) / Bellow (Red)		1
7	Toz Lastığı / Dust Cover		1	
8	429001	Perno Tapası / Bolt Plug	Ø 58x28 mm	1
9	428003	O-ring / O-Ring		1
10	429003	Perno Yüzüğü / Caliper Bolt Ring	Ø 36,5x11 mm	1
11	424003	Kaliper Perno / Caliper Bolt	Ø 36x114 mm	1

KNOR

MERCEDES / MAN

421253

Kaliper Körük Tamir Takımı / Caliper Dust Cover Set

SB5 - SN5 series

Orjinal No : 0004206883 / 81508225005

Cross No : 358470861



Tip / Application

ALL SB5..., SERIES

S.No.	Ekersan No.	Ürün Tanıtımı / Description	Ölçü/Dimension	Miktar/Qty.
1	428001	Klips / Clamp	Ø 34x8x58 mm	1
2	423005	Körük (Kırmızı) / Bellow (Red)		1
3	428002	Fiber O-ring / Fiber O-Ring	Ø 34x8x58 mm	1
4	423006	Körük (Siyah) / Bellow (Black)		1

KNOR

426002

Metal Burç / Caliper Pin Bush (Yellow)

SB5 - SN5 series

Orjinal No :

Cross No :



Tip / Application

ALL SB..., SN..., SK..., SERIES

S.No.	Ekersan No.	Ürün Tanıtımı / Description	Ölçü/Dimension	Miktar/Qty.
1	426002	Metal Burç / Caliper Pin Bush (Yellow)	Ø 36x8x82 mm	1

421106

Toz Lastığı Tamir Takimi / Caliper Tappet & Boot Kit (Ø 74 mm)

SB6 - SB7 series

Original No: 8580320530 / 3434380400 / 0004208892 / 0004208892 / 81268238003 / 81509326022 / 81508229832 / 1143421 / 1246824 / 1793389

Cross No : 8008944 8018804



S.No.	Ekersan No.	Ürün Tanıtım / Description	Ölçü/Dimension	Miktar/Qty.
1	423003	Pabuçlu Lastik / Trust Part With Bellow	Ø 74,00 mm	2
2	423004	Toz Lastığı / Shaft Body Dust Rubber	Ø 74,00 mm	2
3	426000	Metal Burç / Tappet Bush	Ø 15x15x10 mm	2

Tip / Application

ALL SB6..., SB7..., SERIES

421107

Kaliper Toz Lastığı Tamir Takimi (Ø 74 mm) / Caliper Tappet & Boot Kit (Ø 74 mm)

SB6 - SB7 series

Original No:

Cross No : 179320065304130045



S.No.	Ekersan No.	Ürün Tanıtım / Description	Ölçü/Dimension	Miktar/Qty.
1	423003	Pabuçlu Lastik / Trust Part With Bellow	Ø 74,00 mm	2
2	426000	Metal Burç / Tappet Bush	Ø 15x15x10 mm	2

Tip / Application

ALL SB5..., SB6..., SB7..., SERIES

421108

Kaliper Toz Lastığı Tamir Takimi (Ø 74 mm) / Caliper Tappet & Boot Kit (Ø 74 mm)

SB6 - SB7 series

Original No:

Cross No :



S.No.	Ekersan No.	Ürün Tanıtım / Description	Ölçü/Dimension	Miktar/Qty.
1	423003	Pabuçlu Lastik / Trust Part With Bellow	Ø 74,00 mm	1
2	426000	Metal Burç / Tappet Bush	Ø 15x15x10 mm	1

Tip / Application

ALL SB6..., SB7..., SERIES

KNOR

421110

Kaliper Toz Lastığı Tamir Takımı (Ø 74 mm) / Caliper Tappet & Boot Kit (Ø 74 mm)

SB6 - SB7 series

Original No:

Cross No :



Tip / Application

ALL SB5..., SB6..., SB7..., SERIES

S.No.	Ebersan No.	Ürün Tanımı / Description	Ölçü/Dimension	Miktar/Qty.
1	423003	Pabuçla Lastik / Trust Part With Bellow	Ø 74,00 mm	2
2	423004	Toz Lastığı / Shaft Body Dust Rubber	Ø 74,00 mm	2
3	426001	Metal Burç / Tappet Bush	Ø 18x16x11 mm	2
4	423005	Körük (Kırmızı) / Bellow (Red)		1
5	426002	Fiber O-ring / Fiber O-Ring	Ø 34x18x50 mm	1
6	423006	Körük (Siyah) / Bellow (Black)		1
7	428001	Keleçe / Clamp	Ø 34x18x50 mm	1
8	429001	Pano Tapası / Bolt Plug	Ø 58x8 mm	1
9	426003	O-ring / O-Ring		1
10	423007	Plastik Burç / Plastic Bushing		1

KNOR

421111

Kaliper Toz Lastığı Tamir Takımı (Ø 74 mm) / Caliper Tappet & Boot Kit (Ø 74 mm)

SB6 - SB7 series

Original No:

Cross No :



Tip / Application

ALL SB6..., SB7..., SERIES

S.No.	Ebersan No.	Ürün Tanımı / Description	Ölçü/Dimension	Miktar/Qty.
1	423003	Pabuçla Lastik / Trust Part With Bellow	Ø 74,00 mm	2
2	426001	Metal Burç / Tappet Bush	Ø 18x16x11 mm	2
3	423005	Körük (Kırmızı) / Bellow (Red)		1
4	426002	Fiber O-ring / Fiber O-Ring	Ø 34x18x50 mm	1
5	423006	Körük (Siyah) / Bellow (Black)		1
6	428001	Keleçe / Clamp	Ø 34x18x50 mm	1
7	423007	Plastik Burç / Plastic Bushing		1

KNOR

421122

Masura Bilya Yatığı / Caliper Lever (Angel : 0°)

SB6 - SB7 series

Original No:

Cross No :



Tip / Application

ALL SB6..., SB7..., SERIES

S.No.	Ebersan No.	Ürün Tanımı / Description	Ölçü/Dimension	Miktar/Qty.
1	421122	Masura Bilya Yatığı / Caliper Lever (Angel : 0°)	Ag / Angel : 0°	1

KNOR

421124

Masura Bilya Yatagi / Caliper Lever (Angel : 0°)

SB6 - SB7 series

Orjinal No:

Cross No :



S.No.	Ekersan No.	Ürün Tanıtımı / Description	Ölçü/Dimension	Miktar/Qty.
1	421124	Masura Bilya Yatagi / Caliper Lever (Angel : 0°)	Açı / Angel : 0°	1

Tip / Application

ALL SB6..., SB7..., SERIES

KNOR

421125

Masura Bilya Yatagi / Caliper Lever (Angel : 12°)

SB6 - SB7 series

Orjinal No:

Cross No :



S.No.	Ekersan No.	Ürün Tanıtımı / Description	Ölçü/Dimension	Miktar/Qty.
1	421125	Masura Bilya Yatagi / Caliper Lever (Angel : 12°)	Açı / Angel : 12°	1

Tip / Application

ALL SB6..., SB7..., SERIES

KNOR

421127

Kaliper Ayar Mekanizması (Yaylı) / Caliper Adjusting Mechanism (With Spring)

SB6 - SB7 series

Orjinal No:

Cross No :



S.No.	Ekersan No.	Ürün Tanıtımı / Description	Ölçü/Dimension	Miktar/Qty.
1	421127	Ayar Mekanizması Yaylı / Caliper Adjusting Mechanism (With Spring)		1

Tip / Application

ALL SB6..., SB7..., SN6..., SN7..., SK7..., SERIES

KNOR

421128

Kaliper Mekanizması Bilyalı / Caliper Adjusting Mechanism Shaft

SB6 - SB7 series

Orjinal No:

Cross No :



S.No.	Ekersan No.	Ürün Tanıtımı / Description	Ölçü/Dimension	Miktar/Qty.
1	421128	Kaliper Mekanizması / Caliper Adjusting Mechanism Shaft		1

Tip / Application

ALL SB..., SN..., SK..., SERIES

KNOR

421129

Kaliper Dürbünü / Caliper Bridge Assembly

SB6 - SB7 series

Orjinal No:

Cross No :



S.No.	Ekersan No.	Ürün Tanıtımı / Description	Ölçü/Dimension	Miktar/Qty.
1	421129	Kaliper Dürbünü / Caliper Bridge Assembly		1

Tip / Application

ALL SB6..., SB7..., SERIES

KNOR

421130

Kaliper Dürbün Takimi / Caliper Bridge Assembly - Set

SB6 - SB7 series

Orjinal No:

Cross No :



S.No.	Ekersan No.	Ürün Tanıtımı / Description	Ölçü/Dimension	Miktar/Qty.
1	421129	Kaliper Dürbünü / Caliper Bridge Assembly		1
2	421138	Kaliper Ayar Civatası / Caliper Calibration Bolt		2
3	421348	Bilya Yatak Burcu / Caliper Bushing for Leveler		1

Tip / Application

ALL SB6..., SB7..., SERIES

KNOR

421131

Kaliper Dürbün Takımı / Caliper Bridge Assembly - Set

SB6 - SB7 series

Orjinal No:

Cross No :



S.No.	Ekersan No.	Ürün Tanıtımı / Description	Ölçü/Dimension	Miktar/Qty.
1	421129	Kaliper Dürbünü / Caliper Bridge Assembly		1

Tip / Application

ALL SB6..., SB7..., SERIES

KNOR

421138

Kaliper Ayar Civatası / Caliper Calibration Bolt

SB6 - SB7 series

Orjinal No:

Cross No :



S.No.	Ekersan No.	Ürün Tanıtımı / Description	Ölçü/Dimension	Miktar/Qty.
1	421130	Kaliper Ayar Civatası / Caliper Calibration Bolt		1

Tip / Application

ALL SB5..., SB6..., SB7..., SN6..., SN7..., SK7..., SERIES

KNOR

421139

Kaliper Mekanizma Zinciri (29 Bakla) / Caliper Calibration Shaft Chain (29 Links)

SB6 - SB7 series

Orjinal No:

Cross No :



S.No.	Ekersan No.	Ürün Tanıtımı / Description	Ölçü/Dimension	Miktar/Qty.
1	421139	Mekanizma Zinciri / Caliper Calibration Shaft Chain (29 Links)		1

Tip / Application

ALL SB6..., SB7..., SN6..., SN7..., SK7..., SERIES

KNOR

421142

Kaliper Ayar Dişlisi / Caliper Mechanism Gear

SB6 - SB7 series

Orjinal No:

Cross No :



S.No.	Ekarsan No.	Ürün Tanıtımı / Description	Ölçü/Dimension	Miktar/Qty.
1	421142	Kaliper Ayar Dişlisi / Caliper Mechanism Gear		1

Tip / Application

ALL SB6... SB7 ... SN6... SN7... SERIES

KNOR

421146

Kaliper Masura Bilya Takımı / Caliper Roller Bearing Set

SB6 - SB7 series

Orjinal No:

Cross No :



S.No.	Ekarsan No.	Ürün Tanıtımı / Description	Ölçü/Dimension	Miktar/Qty.
1	421146	Kaliper Masura Bilya / Caliper Roller Bearing		2

Tip / Application

ALL SN5... SN6... SN7... SK7... SERIES

KNOR

421147

Kaliper Masura Bilya Takımı / Caliper Roller Bearing Set

SB6 - SB7 series

Orjinal No:

Cross No :



S.No.	Ekarsan No.	Ürün Tanıtımı / Description	Ölçü/Dimension	Miktar/Qty.
1	421147	Kaliper Masura Bilya / Caliper Roller Bearing		2

Tip / Application

ALL SB5... SB6... SB7... SN6... SN7... SK7... SERIES

KNOR

421148

Kaliper Bilya Yatak Burcu / Caliper Bushing for Leveller

SB6 - SB7 series

Orjinal No:

Cross No :



S.No.	Ekersan No.	Ürün Tanıtımı / Description	Ölçü/Dimension	Miktar/Qty.
1	421148	Bilya Yatak Burcu / Caliper Bushing for Leveller		1

Tip / Application

ALL SB6..., SB7..., SN6..., SN7..., SK7..., SERIES

KNOR

421149

Mekanizma Ayar Somunu / Adjusting Nut

SB6 - SB7 series

Orjinal No:

Cross No :



S.No.	Ekersan No.	Ürün Tanıtımı / Description	Ölçü/Dimension	Miktar/Qty.
1	421149	Mekanizma Ayar Somunu / Adjusting Nut		1

Tip / Application

ALL SB6..., SB7..., SERIES

KNOR

421151

Kaliper Plastik Kapak Sensörlü (3 Pinli) / Caliper Plastic Cover With Sensor (3 Lines)

SB6 - SB7 series

Orjinal No:

Cross No :



S.No.	Ekersan No.	Ürün Tanıtımı / Description	Ölçü/Dimension	Miktar/Qty.
1	421151	Plastik Kapak Sensörlü / Caliper Plastic Cover With Sensor (3 Lines)		1

Tip / Application

ALL SB6..., SB7..., SN6..., SN7..., SK7..., SERIES

KNOR

421152

Kaliper Plastik Kapak Sensörlü (2 Pinli) / Caliper Plastic Cover With Sensor (2 Lines)

SB6 - SB7 series

Orjinal No:

Cross No :



S.No.	Ekersan No.	Ürün Tanıtımı / Description	Ölçü/Dimension	Miktar/Qty.
1	421152	Plastik Kapak Sensörlü / Caliper Plastic Cover With Sensor (2 Lines)		1

Tip / Application

ALL SB6..., SB7..., SN6..., SN7..., SK7... SERIES

KNOR

421153

Kaliper Plastik Kapak Sensörsüz / Caliper Plastic Cover Without Sensor

SB6 - SB7 series

Orjinal No:

Cross No :



S.No.	Ekersan No.	Ürün Tanıtımı / Description	Ölçü/Dimension	Miktar/Qty.
1	421153	Plastik Kapak Sensörsüz / Caliper Plastic Cover Without Sensor		1

Tip / Application

ALL SB6..., SB7..., SN6..., SN7..., SK7... SERIES

KNOR

421154

Kaliper Perno Tamir Takımı / Caliper Pin Repair Kit

SB6 - SB7 series

Orjinal No: 000A20282 / 81508228009 / 1390A27 / 93162048 / 3205565 / 39421A2 / 3198253 / 329815A / 1A40915

Cross No : *328790662339688962369180062*



S.No.	Ekersan No.	Ürün Tanıtımı / Description	Ölçü/Dimension	Miktar/Qty.
1	424005	Kaliper Perno / Caliper Bolt	Ø 14x88 mm	1
2	425001	Kaliper Vidası / Caliper Screw	M16x1,5x85 mm	1
3	425002	Kaliper Vidası / Caliper Screw	M16x1,5x150 mm	1
4	423005	Körük (Kırmızı) / Bellow (Red)		1
5	428002	Fiber O-ring / Fiber O-Ring	Ø 34x48x58 mm	1
6	423006	Körük (Siyah) / Bellow (Black)		1
7	421182	Lastik Burç (Uzun) / Caliper Pin Rubber Bush (Long)	Ø 36x48x73 mm	1
8	426002	Metal Burç / Caliper Pin Bush (Yellow)	Ø 36x48x82 mm	1
9	423007	Plastik Burç / Plastic Bushing		1
10	424001	Kaliper Perno / Caliper Bolt	Ø 36x145 mm	1

Tip / Application

ALL SB5..., SB6..., SB7... SERIES

MERCEDES / MAN / SCANIA / IVECO / NEOPLAN / DAF

421155

Kaliper Perno Tamir Takimi / Caliper Pin Repair Kit

SB6 - SB7 series

Original No : 343A381200

Cross No : K080935



S.No.	Ekarsan No.	Ürün Tanıtımı / Description	Ölçü/Dimension	Miktar/Qty.
1	424001	Kaliper Pernoşu / Caliper Bolt	Ø 36x145 mm	1
2	425002	Kaliper Vidası / Caliper Screw	M16x1,5x150 mm	1
3	423005	Körük (Kırmızı) / Bellow (Red)		1
4	428002	Fiber O-ring / Fiber O-Ring	Ø 34x40x50 mm	1
5	423006	Körük (Siyah) / Bellow (Black)		1
6	428001	Kilçeye / Clamp	Ø 34x40x50 mm	1
7	426002	Head Bush / Caliper Pin Bush (Yellow)	Ø 36x40x32 mm	1

Tip / Application

All SB5..., SB6..., SB7..., SERIES

421156

Kaliper Perno Tamir Takimi / Caliper Pin Repair Kit

SB6 - SB7 series

Original No : 4250481

Cross No : 37019F0062



S.No.	Ekarsan No.	Ürün Tanıtımı / Description	Ölçü/Dimension	Miktar/Qty.
1	424003	Kaliper Pernoşu / Caliper Bolt	Ø 36x114 mm	1
2	424004	Kaliper Pernoşu / Caliper Bolt	Ø 32x80 mm	1
3	425001	Kaliper Vidası / Caliper Screw	M16x1,5x85 mm	2
4	423005	Körük (Kırmızı) / Bellow (Red)		1
5	428002	Fiber O-ring / Fiber O-Ring	Ø 34x40x50 mm	1
6	426002	Head Bush / Caliper Pin Bush (Yellow)	Ø 36x40x32 mm	1
7	423007	Plastik Burç / Plastic Bushing		1
8	423007	Plastik Burç / Plastic Bushing		1
9	428003	O-ring / O-Ring		1

Tip / Application

421157

Kaliper Perno Tamir Takimi / Caliper Pin Repair Kit

SB6 - SB7 series

Original No : 0004202182

Cross No : K080132



S.No.	Ekarsan No.	Ürün Tanıtımı / Description	Ölçü/Dimension	Miktar/Qty.
1	424002	Kaliper Pernoşu / Caliper Bolt	Ø 36x135 mm	1
2	424005	Kaliper Pernoşu / Caliper Bolt	Ø 34x80 mm	1
3	425003	Kaliper Vidası / Caliper Screw	M16x1,5x140 mm	1
4	425001	Kaliper Vidası / Caliper Screw	M16x1,5x85 mm	1
5	423005	Körük (Kırmızı) / Bellow (Red)		1
6	428002	Fiber O-ring / Fiber O-Ring	Ø 34x40x50 mm	1
7	426002	Head Bush / Caliper Pin Bush (Yellow)	Ø 36x40x32 mm	1
8	421182	Lastikli Burç (Uzun) / Caliper Pin Rubber Bush (Long)	Ø 36x40x73 mm	1
9	423006	Körük (Siyah) / Bellow (Black)		1
10	428001	Kilçeye / Clamp	Ø 34x40x50 mm	1

Tip / Application

421158

SB6 - SB7 series

Kaliper Perno Tamir Takımı / Caliper Pin Repair Kit

Orjinal No: 343428000 / 1446918

Cross No : 38847884



S.No.	Ekarsan No.	Ürün Tanıtımı / Description	Ölçü/Dimension	Miktar/Qty.
1	425001	Kaliper Vidası / Caliper Screw	M16x1,5x85 mm	1
2	423007	Plastik Burç / Plastic Bushing		1
3	424005	Kaliper Perno / Caliper Bolt	Ø 14x88 mm	1

Tip / Application

ALL SB5..., SB6..., SB7..., SERIES

421159

SB6 - SB7 series

Kaliper Perno Tamir Takımı / Caliper Pin Repair Kit

Orjinal No:

Cross No :



S.No.	Ekarsan No.	Ürün Tanıtımı / Description	Ölçü/Dimension	Miktar/Qty.
1	424002	Kaliper Perno / Caliper Bolt	Ø 36x135 mm	1
2	424005	Kaliper Perno / Caliper Bolt	Ø 14x88 mm	1
3	423005	Körük (Kırmızı) / Bellow (Red)		1
4	426002	Fiber O-ring / Fiber O-Ring	Ø 34x48x8 mm	1
5	426002	Metal Burç / Caliper Pin Bush (Yellow)	Ø 16x48x82 mm	1
6	423007	Plastik Burç / Plastic Bushing		1
7	423006	Körük (Siyah) / Bellow (Black)		1
8	428001	Kaleçe / Clamp	Ø 34x48x8 mm	1

Tip / Application

ALL SB6..., SB7..., SERIES

421160

SB6 - SB7 series

Kaliper Perno Tamir Takımı / Caliper Pin Repair Kit

Orjinal No:

Cross No :



S.No.	Ekarsan No.	Ürün Tanıtımı / Description	Ölçü/Dimension	Miktar/Qty.
1	424002	Kaliper Perno / Caliper Bolt	Ø 36x135 mm	1
2	425003	Kaliper Vidası / Caliper Screw	M16x1,5x140 mm	1
3	423005	Körük (Kırmızı) / Bellow (Red)		1
4	426002	Fiber O-ring / Fiber O-Ring	Ø 34x48x8 mm	1
5	426002	Metal Burç / Caliper Pin Bush (Yellow)	Ø 16x48x82 mm	1
6	423006	Körük (Siyah) / Bellow (Black)		1
7	428001	Kaleçe / Clamp	Ø 34x48x8 mm	1

Tip / Application

ALL SB6..., SB7..., SERIES

KNOR

421162

Kaliper Körük Takımı / Caliper Bellow Set

SB6 - SB7 series

Original No:

Cross No :



S.No.	Ekersan No.	Ürün Tanıtımı / Description	Ölçü/Dimension	Miktar/Qty.
1	428002	Fiber O-ring / Fiber O-Ring	Ø 34x40x50 mm	1
2	423005	Körük (Kırmızı) / Bellow (Red)		1

Tip / Application

ALL SB5..., SB6..., SB7..., SERIES

KNOR

421164

Kaliper Perno Tamir Takımı / Caliper Pin Repair Kit

SB6 - SB7 series

Original No:

Cross No :



S.No.	Ekersan No.	Ürün Tanıtımı / Description	Ölçü/Dimension	Miktar/Qty.
1	424004	Kaliper Perno / Caliper Bolt	Ø 32x80 mm	1
2	425001	Kaliper Vidası / Caliper Screw	M16x1,5x85 mm	1
3	421881	Lastikli Burç (Kısa) / Caliper Pin Rubber Bush - (Short)	Ø 39x40x55 mm	1

Tip / Application

ALL SB7..., SERIES

KNOR

MERCEDES / MAN / NECO / BPW

421166

Kaliper Perno Tamir Takımı / Caliper Pin Repair Kit

SB6 - SB7 series

Original No: 0004202982 / 81508228023 / 42518802 / 0900186298

Cross No : K080373



S.No.	Ekersan No.	Ürün Tanıtımı / Description	Ölçü/Dimension	Miktar/Qty.
1	424004	Kaliper Perno / Caliper Bolt	Ø 32x80 mm	1
2	425001	Kaliper Vidası / Caliper Screw	M16x1,5x85 mm	1
3	425004	Kaliper Vidası / Caliper Screw	M16x1,5x80 mm	1
4	423005	Körük (Kırmızı) / Bellow (Red)		1
5	428002	Fiber O-ring / Fiber O-Ring	Ø 34x40x50 mm	1
6	426002	Metal Burç / Caliper Pin Bush (Yellow)	Ø 36x40x82 mm	1
7	421182	Lastikli Burç (Uzun) / Caliper Pin Rubber Bush (Long)	Ø 39x40x73 mm	1
8	428001	Perno Tapası / Bolt Plug	Ø 50x28 mm	1
9	428003	O-ring / O-Ring		1
10	429003	Perno Yüzüğü / Caliper Bolt Ring	Ø 26,5x11 mm	1
11	424003	Kaliper Perno / Caliper Bolt	Ø 36x114 mm	1

Tip / Application

ALL SB5..., SB6..., SB7..., SN6..., SN7..., SERIES

KNOR

BPW / SAF

421168

Kaliper Perno Tamir Takımı / Caliper Pin Repair Kit

SB6 - SB7 series

Orjinal No: 058030000 / 3424381300

Cross No : 8300698



Ø 32 x 80 mm

80 mm

Ø 39 mm

S.No.	Ekersan No.	Ürün Tanıtımı / Description	Ölçü/Dimension	Miktar/Qty.
1	425001	Kaliper Vidası / Caliper Screw	M16x1,5x80 mm	1
2	421182	Lastik Buç (Uzun) / Caliper Pin Rubber Bush (Long)	Ø 39x48x73 mm	1
3	429003	Perno Yüzüğü / Caliper Bolt Ring	Ø 26,5x11 mm	1
4	424004	Kaliper Peması / Caliper Bolt	Ø 32x88 mm	1

Tip / Application

ALL SB5..., SB6..., SB7..., SP6..., SN7..., SK7..., SERIES

KNOR

MERCEDES / SAF / SCAMA

421169

Kaliper Perno Tamir Takımı / Caliper Pin Repair Kit

SB6 - SB7 series

Orjinal No: 0004200300 / 3434380500 / 147075

Cross No : 83006951837886



Ø 36 x 114 mm

85 mm

S.No.	Ekersan No.	Ürün Tanıtımı / Description	Ölçü/Dimension	Miktar/Qty.
1	424003	Kaliper Peması / Caliper Bolt	Ø 36x114 mm	1
2	425001	Kaliper Vidası / Caliper Screw	M16x1,5x85 mm	1
3	423005	Körük (Kırmızı) / Bellow (Red)		1
4	428002	Fiber O-ring / Fiber O-Ring	Ø 34x48x58 mm	1
5	426002	Metal Buç / Caliper Pin Bush (Yellow)	Ø 36x48x82 mm	1
6	429001	Perno Tapası / Bolt Plug	Ø 58x28 mm	1
7	428003	O-ring / O-Ring		1

Tip / Application

KNOR

421170

Kaliper Perno Tamir Takımı / Caliper Pin Repair Kit

SB6 - SB7 series

Orjinal No:

Cross No :



Ø 39 mm

85 mm

85 mm

80 mm

Ø 36 x 114 mm

Ø 32 x 80 mm

Ø 34 x 80 mm

S.No.	Ekersan No.	Ürün Tanıtımı / Description	Ölçü/Dimension	Miktar/Qty.
1	424003	Kaliper Peması / Caliper Bolt	Ø 36x114 mm	1
2	424004	Kaliper Peması / Caliper Bolt	Ø 32x88 mm	1
3	424005	Kaliper Peması / Caliper Bolt	Ø 34x88 mm	1
4	425001	Kaliper Vidası / Caliper Screw	M16x1,5x85 mm	2
5	425004	Kaliper Vidası / Caliper Screw	M16x1,5x80 mm	1
6	423005	Körük (Kırmızı) / Bellow (Red)		1
7	428002	Fiber O-ring / Fiber O-Ring	Ø 34x48x58 mm	1
8	421181	Lastik Buç (Kısa) / Caliper Pin Rubber Bush - (Short)	Ø 39x48x55 mm	1
9	429001	Perno Tapası / Bolt Plug	Ø 58x28 mm	1
10	428003	O-ring / O-Ring		1
11	426002	Metal Buç / Caliper Pin Bush (Yellow)	Ø 36x48x82 mm	1

Tip / Application

ALL SB7..., SERIES

421174

Kaliper Perno Kapak Takımı / Caliper Pin Cap Set

SB6 - SB7 series

Orjinal No : 82508228025

Cross No : K881381



S.No.	Ekersan No.	Ürün Tanıtımı / Description	Ölçü/Dimension	Miktar/Qty.
1	428001	Kaleçe / Clamp	Ø 34xØe50 mm	6
2	429001	Perno Tapası / Bolt Plug	Ø 50x28 mm	6
3	428003	O-ring / O-Ring		6
4	423006	Körük (Siyah) / Bellow (Black)		6

Tip / Application

ALL SB..., SN..., SERIES

421175

Kaliper Ayar Mekanizması Kapak Takımı / Caliper Adjusting Mechanism Cap Set

SB6 - SB7 series

Orjinal No : 0004234907 / 0000029001

Cross No : K880029



S.No.	Ekersan No.	Ürün Tanıtımı / Description	Ölçü/Dimension	Miktar/Qty.
1	421149	Mekanizma Ayar Somunu / Adjusting Nut		10
2	423011	Plastik Kapak / Plastic Cover	Ø 38 mm	10

Tip / Application

ALL SB5..., SN5..., SB6..., SB7..., SN6..., SN7..., SK7..., SERIES

421176

Kaliper Ayar Mekanizması Kapak Takımı / Caliper Adjusting Mechanism Cap Set

SB6 - SB7 series

Orjinal No :

Cross No : K883962



S.No.	Ekersan No.	Ürün Tanıtımı / Description	Ölçü/Dimension	Miktar/Qty.
1	421149	Mekanizma Ayar Somunu / Adjusting Nut		10
2	423012	Plastik Kapak / Plastic Cover	Ø 35 mm	10

Tip / Application

ALL SB5..., SN5..., SB6..., SB7..., SN6..., SN7..., SK7..., SERIES

KNOR

421177

Kaliper Kapak Takimi / Caliper Cover Set

SB6 - SB7 series

Orjinal No:

Cross No : 39709F0063



S.No.	Ekersan No.	Ürün Tanıtımı / Description	Ölçü/Dimension	Miktar/Qty.
1	429001	Perno Tapası / Bolt Plug	Ø 58x28 mm	1
2	428003	O-ring / O-Ring		1

Tip / Application

ALL SB6..., SB7..., SERIES

KNOR

SAF / MERCEDES / MAN / SCANIA / DAF / IVECO

421178

Kaliper Perno Lastiği ve Kapak Takimi / Caliper Pin Boot & Cap Set

SB6 - SB7 series

Orjinal No: 058010020 / 0034205236 / 8150226000 / 141520 / 344834 / 9302040

Cross No : 32809061



S.No.	Ekersan No.	Ürün Tanıtımı / Description	Ölçü/Dimension	Miktar/Qty.
1	423005	Körük (Kırmızı) / Bellows (Red)		1
2	428002	Fiber O-ring / Fiber O-Ring	Ø 34x48x58 mm	1
3	429001	Perno Tapası / Bolt Plug	Ø 58x28 mm	1
4	428003	O-ring / O-Ring		1

Tip / Application

ALL SB6..., SB7..., SERIES

KNOR

MERCEDES

421179

Kaliper Balata Tutucu Tamir Takımı / Caliper Pad Retainer Repair Kit

SB6 - SB7 series

Orjinal No: 000420002

Cross No : *1971208430679084197120851*



S.No.	Ekersan No.	Ürün Tanıtımı / Description	Ölçü/Dimension	Miktar/Qty.
1	422004	Mm / Mm		1
2	428004	Pl / Washer		1
3	428005	Kopilya / Cotter Pin		1
4	428006	Kaliper Tutucu / Brake Pad Retainer		1

Tip / Application

ALL SB..., SN..., SK..., SERIES

KNOR

421180

Balata Tutucu & Ayar Somun Takımı / Pad Retainer & Mechanism Adapter Kit

SB6 - SB7 series

Orjinal No:

Cross No :



S.No.	Ekersan No.	Ürün Tanımı / Description	Ölçü/Dimension	Miktar/Qty.
1	421169	Mekanizma Ayar Somunu / Adjusting Nut		1
2	422004	Pim / Pin		2
3	429004	Pal / Washer		2
4	429005	Kopilya / Cotter Pin		2
5	423011	Plastik Kapak / Plastic Cover	Ø 38 mm	2

Tip / Application

ALL SB..., SN..., SK..., SERIES

KNOR

421181

Lastikli Burç (Kısa) / Caliper Pin Rubber Bush - (Short)

SB6 - SB7 series

Orjinal No:

Cross No :



Ø 39 mm

S.No.	Ekersan No.	Ürün Tanımı / Description	Ölçü/Dimension	Miktar/Qty.
1	421381	Lastikli Burç (Kısa) / Caliper Pin Rubber Bush - (Short)	Ø 39x40x55 mm	1

Tip / Application

ALL SB6..., SB7... SERIES

KNOR

421182

Lastikli Burç (Uzun) / Caliper Pin Rubber Bush (Long)

SB6 - SB7 series

Orjinal No:

Cross No :



39 mm

S.No.	Ekersan No.	Ürün Tanımı / Description	Ölçü/Dimension	Miktar/Qty.
1	421182	Lastikli Burç (Uzun) / Caliper Pin Rubber Bush (Long)	Ø 39x40x73 mm	1

Tip / Application

ALL SB6..., SB7... SERIES

KNOR

421188

Masura Bilya Yatagi / Caliper Lever (Angel : 93°)

SB6 - SB7 series

Orjinal No:

Cross No :



S.No.	Ekersan No.	Ürün Tanıtımı / Description	Ölçü/Dimension	Miktar/Qty.
1	421188	Masura Bilya Yatagi / Caliper Lever (Angel : 93°)	Açı / Angel : 93°	1

Tip / Application

ALL SB6..., SB7..., SERIES

KNOR

421191

Kaliper Perno & Lastikli Burç (Uzun) / Caliper Pin & Bush (Long)

SB6 - SB7 series

Orjinal No:

Cross No : 8300697



S.No.	Ekersan No.	Ürün Tanıtımı / Description	Ölçü/Dimension	Miktar/Qty.
1	421192	Lastikli Burç (Uzun) / Caliper Pin Rubber Bush (Long)	Ø 39x48x73 mm	1
2	424004	Kaliper Pernosu / Caliper Bolt	Ø 32x80 mm	1

Tip / Application

ALL SB5..., SB5..., SB6..., SB7..., SB6..., SB7..., SB7..., SERIES

KNOR

421192

Kaliper Ayar Mekanizması Kapak Takımı / Caliper Adjusting Mechanism Cap Set

SB6 - SB7 series

Orjinal No: 0208020024

Cross No : 8300945



S.No.	Ekersan No.	Ürün Tanıtımı / Description	Ölçü/Dimension	Miktar/Qty.
1	420149	Mekanizma Ayar Somunu / Adjusting Nut		10
2	428037	Kaliper Keçisi / Caliper Seal		10
3	425011	Plastik Kapak / Plastic Cover	Ø 38 mm	10

Tip / Application

ALL SB5..., SB5..., SB6..., SB7..., SB6..., SB7..., SB7..., SERIES

MAN

KNOR

421193

Kaliper Perno Tamir Takımı / Caliper Pin Repair Kit

SB6 - SB7 series

Orjinal No:

Cross No :



S.No.	Ekersan No.	Ürün Tanıtım / Description	Ölçü/Dimension	Miktar/Qty.
1	423007	Plastik Burç / Plastic Bushing		1
2	424005	Kaliper Perno / Caliper Bolt	Ø 34x60 mm	1

Tip / Application

ALL SB5..., SB6..., SB7..., SERIES

KNOR

421194

Kaliper Perno & Lastikli Burç (Uzun) / Caliper Pin & Bush (Long)

SB6 - SB7 series

Orjinal No:

Cross No :



S.No.	Ekersan No.	Ürün Tanıtım / Description	Ölçü/Dimension	Miktar/Qty.
1	423252	Lastikli Burç (Uzun) / Caliper Pin Rubber Bush(Long)	Ø 35x60x73 mm	1
2	424004	Kaliper Perno / Caliper Bolt	Ø 32x60 mm	1

Tip / Application

ALL SB5..., SN5..., SB6..., SB7..., SERIES

KNOR

421195

Mekanizma Ayar Somunu Seti / Adjusting Nut - Set

SB6 - SB7 series

Orjinal No:

Cross No : J001548



S.No.	Ekersan No.	Ürün Tanıtım / Description	Ölçü/Dimension	Miktar/Qty.
1	421149	Mekanizma Ayar Somunu / Adjusting Nut		10

Tip / Application

ALL SB..., SN..., SK..., SERIES

KNOR

421196

Balata Tutucu & Ayar Somun Takımı / Pad Retainer & Mechanism Adapter Kit

SB6 - SB7 series

Original No:

Cross No :

S.No.	Ekersan No.	Ürün Tanıtımı / Description	Ölçü/Dimension	Miktar/Qty.
1	420149	Mekanizma Ayar Somunu / Adjusting Nut		1
2	422004	Pim / Pin		2
3	428004	Pl / Washer		2
4	428005	Kopilya / Cotter Pin		2
5	428060	Disk Balata Yay / Brake Pad Spring		2
6	423002	Plastik Kapak / Plastic Cover	Ø 35 mm	2



Tip / Application

ALL SB..., SN..., SK..., SERIES

KNOR

421197

Kaliper Perno Tamir Takımı / Caliper Pin Repair Kit

SB6 - SB7 series

Original No: 080100000

Cross No :

S.No.	Ekersan No.	Ürün Tanıtımı / Description	Ölçü/Dimension	Miktar/Qty.
1	425004	Kaliper Vidası / Caliper Screw	M16x1,5x80 mm	1
2	421252	Lastikli Buç (Uzun) / Caliper Pin Rubber Bush (Long)	Ø 35x48x71 mm	1
3	429003	Perno Yüzüğü / Caliper Bolt Ring	Ø 24,5x11 mm	1
4	424004	Kaliper Pernosu / Caliper Bolt	Ø 32x88 mm	1



Tip / Application

ALL SB5..., SM5..., SB6..., SB7..., SN6..., SN7..., SK7..., SERIES

KNOR

421198

Kaliper Plastik Kapak Sensörlü (3 Pinli) / Caliper Plastic Cover With Sensor (3 Lines)

SB6 - SB7 series

Original No:

Cross No :

S.No.	Ekersan No.	Ürün Tanıtımı / Description	Ölçü/Dimension	Miktar/Qty.
1	421198	Plastik Kapak Sensörlü / Caliper Plastic Cover With Sensor (3 Lines)		1



Tip / Application

ALL SB6..., SB7..., SN6..., SN7..., SK7..., SERIES

KNOR

421199

Kaliper Ayar Mekanizması (Yaysız) / Caliper Adjusting Mechanism (Without Spring)

SB6 - SB7 series

Orjinal No:

Cross No :



S.No.	Ekersan No.	Ürün Tanıtımı / Description	Ölçü/Dimension	Miktar/Qty.
1	421199	Ayar Mekanizması Yaysız / Caliper Adjusting Mechanism (Without Spring)		1

Tip / Application

ALL SB5..., SB6..., SB7..., SERIES

KNOR

421200

Kaliper Plastik Kapak Sensörsüz / Caliper Plastic Cover Without Sensor

SB6 - SB7 series

Orjinal No:

Cross No :



S.No.	Ekersan No.	Ürün Tanıtımı / Description	Ölçü/Dimension	Miktar/Qty.
1	421200	Plastik Kapak Sensörsüz / Caliper Plastic Cover Without Sensor		1

Tip / Application

ALL SB6..., SB7..., SN6..., SN7..., SK7..., SERIES

KNOR

421201

Kaliper Plastik Kapak Sensörlü (2 Pini) / Caliper Plastic Cover With Sensor (2 Lines)

SB6 - SB7 series

Orjinal No:

Cross No :



S.No.	Ekersan No.	Ürün Tanıtımı / Description	Ölçü/Dimension	Miktar/Qty.
1	421201	Plastik Kapak Sensörlü / Caliper Plastic Cover With Sensor		1

Tip / Application

ALL SB6..., SB7..., SN6..., SN7..., SK7..., SERIES

KNOR

421202

Kaliper Tapa Seti / Caliper Plug Kits

SB6 - SB7 series

Orjinal No:

Cross No :



S.No.	Ekersan No.	Ürün Tanıtımı / Description	Ölçü/Dimension	Miktar/Qty.
1	421202	Kaliper Tapası / Caliper Plug		5

Tip / Application

ALL SB5..., SB6..., SB7..., SN6..., SN7..., SK7..., SERIES

KNOR

421203

Kaliper Balata Tutucu Tamir Takımı / Caliper Pad Retainer Repair Kit

SB6 - SB7 series

Orjinal No:

Cross No :



S.No.	Ekersan No.	Ürün Tanıtımı / Description	Ölçü/Dimension	Miktar/Qty.
1	423149	Mekanizma Ayar Somunu / Adjusting Nut		1
2	428037	Kaliper Keçesi / Caliper Seal		1
3	428006	Kaliper Tutucu / Brake Pad Retainer		1
4	422004	Pin / Pin		1
5	428004	Pil / Washer		1
6	428005	Kopilya / Cotter Pin		1
7	423011	Plastik Kapak / Plastic Cover	Ø 38 mm	2

Tip / Application

ALL SB5..., SN5..., SB6..., SB7..., SN6..., SN7..., SK7..., SERIES

KNOR

421215

Kaliper Perno Tamir Takımı / Caliper Pin Repair Kit

SB6 - SB7 series

Orjinal No:

Cross No :



S.No.	Ekersan No.	Ürün Tanıtımı / Description	Ölçü/Dimension	Miktar/Qty.
1	424037	Kaliper Peması / Caliper Bolt	Ø 34x120 mm	1
2	423051	Plastik Buçuk / Rubber Bushing	Ø 48x34x95 mm	1

Tip / Application

SB7521, SB7581, SB7661, SB7580,

421216

Kaliper Perno Tamir Takimi / Caliper Pin Repair Kit

SB6 - SB7 series

Original No : 142543 / 009420182

Cross No : 35810042



S.No.	Ekerson No.	Ürün Tanıtımı / Description	Ölçü/Dimension	Miktar/Qty.
1	424001	Kaliper Pernosu / Caliper Bolt	Ø 36x145 mm	1
2	424037	Kaliper Pernosu / Caliper Bolt	Ø 34x120 mm	1
3	425002	Kaliper Vidası / Caliper Screw	M16x1,5x150 mm	1
4	425034	Kaliper Vidası / Caliper Screw	M16x1,5x125 mm	1
5	423005	Körük (Kırmızı) / Bellow (Red)		1
6	428002	Fiber O-ring / Fiber O-Ring	Ø 34x40x50 mm	1
7	426002	Metal Barç / Caliper Pin Bush (Yellow)	Ø 36x40x82 mm	1
8	428002	Fiber O-ring / Fiber O-Ring	Ø 34x40x50 mm	1
9	428001	Keleçe / Clamp	Ø 34x40x50 mm	1
10	423051	Haşık Barç / Rubber Bushing	Ø 40x34x95 mm	1

Tip / Application

SB7521, SB7581, SB7661, SB7580,

421217

Kaliper Perno Tamir Takimi / Caliper Pin Repair Kit

SB6 - SB7 series

Original No : 1603326

Cross No : 1000287



S.No.	Ekerson No.	Ürün Tanıtımı / Description	Ölçü/Dimension	Miktar/Qty.
1	424001	Kaliper Pernosu / Caliper Bolt	Ø 36x145 mm	1
2	424004	Kaliper Pernosu / Caliper Bolt	Ø 32x80 mm	1
3	425002	Kaliper Vidası / Caliper Screw	M16x1,5x150 mm	1
4	425004	Kaliper Vidası / Caliper Screw	M16x1,5x80 mm	1
5	426002	Metal Barç / Caliper Pin Bush (Yellow)	Ø 36x40x82 mm	1
6	421381	Lastikli Barç (Kısa) / Caliper Pin Rubber Bush - (Short)	Ø 36x40x55 mm	1
7	423005	Körük (Kırmızı) / Bellow (Red)		1
8	421351	Kaliper Burcu / Caliper Pin Rubber Bush	Ø 39 mm	1
9	423006	Körük (Siyah) / Bellow (Black)		1
10	428001	Keleçe / Clamp	Ø 34x40x50 mm	1

Tip / Application

SB7880, K000386,

421218

Kaliper Perno Tamir Takimi / Caliper Pin Repair Kit

SB6 - SB7 series

Original No : 1750280 / 286079

Cross No :



S.No.	Ekerson No.	Ürün Tanıtımı / Description	Ölçü/Dimension	Miktar/Qty.
1	424003	Kaliper Pernosu / Caliper Bolt	Ø 36x114 mm	1
2	424031	Kaliper Pernosu /	Ø 32x84 mm	1
3	425001	Kaliper Vidası / Caliper Screw	M16x1,5x85 mm	1
4	425004	Kaliper Vidası / Caliper Screw	M16x1,5x80 mm	1
5	426002	Metal Barç / Caliper Pin Bush (Yellow)	Ø 36x40x82 mm	1
6	421162	Kaliper Körük Takımı / Caliper Bellow Set		1
7	421177	Kaliper Kapak Takımı / Caliper Cover Set		1
8	423053	Toz Lastiği / Dust Cover		1
9	429002	Perno Tapağı / Bolt Plug	Ø 40x12 mm	1
10	423055	Fiber O-ring (Kırmızı) / Fiber O-Ring (Red)		1
11	423056	Körük (Siyah) / Bellow (Black)		1
12	429020	Perno Tapağı / Plug Bolt		1

Tip / Application

KNOR

421219

Kaliper Perno Tamir Takımı / Caliper Pin Repair Kit

SB6 - SB7 series

Orjinal No:

Cross No : 17932062



S.No.	Ekersan No.	Ürün Tanıtımı / Description	Ölçü/Dimension	Miktar/Qty.
1	426002	Kaliper Pemesi / Caliper Bolt	Ø 36x135 mm	1
2	424037	Kaliper Pemesi / Caliper Bolt	Ø 34x120 mm	1
3	425003	Kaliper Vidası / Caliper Screw	M16x1,5x140 mm	1
4	425034	Kaliper Vidası / Caliper Screw	M16x1,5x125 mm	1
5	426002	Metal Burç / Caliper Pin Bush (Yellow)	Ø 36xØd2 mm	1
6	423051	Plastik Burç / Rubber Bushing	Ø 40x34x95 mm	1
7	423052	Körük (Siyah) / Bellow (Black)		1
8	428002	Fiber O-ring / Fiber O-Ring	Ø 34xØd58 mm	1
9	428001	Kaleçe / Clamp	Ø 34xØd58 mm	1

Tip / Application

ALL SB6..., SB7..., SERIES

KNOR

421220

Plastik Kapak Sensörsüz / Caliper Plastic Cover Without Sensor

SB6 - SB7 series

Orjinal No:

Cross No :



S.No.	Ekersan No.	Ürün Tanıtımı / Description	Ölçü/Dimension	Miktar/Qty.
1	421220	Plastik Kapak Sensörsüz / Caliper Plastic Cover Without Sensor		1

Tip / Application

ALL SB6..., SB7..., SERIES

KNOR

421221

Plastik Kapak Sensörlü / Caliper Plastic Cover With Sensor (2 Lines)

SB6 - SB7 series

Orjinal No:

Cross No :



S.No.	Ekersan No.	Ürün Tanıtımı / Description	Ölçü/Dimension	Miktar/Qty.
1	421221	Plastik Kapak Sensörlü / Caliper Plastic Cover With Sensor (2 Lines)	2 Lines	1

Tip / Application

ALL SB6..., SB7..., SERIES

421249

Kaliper Perno Tamir Takımı / Caliper Pin Repair Kit

SB6 - SB7 series

Orjinal No: 090019530

Cross No : K081532



S.No.	Ekersan No.	Ürün Tanıtımı / Description	Ölçü/Dimension	Miktar/Qty.
1	424004	Kaliper Pernosu / Caliper Bolt	Ø 32x80 mm	1
2	425001	Kaliper Vidası / Caliper Screw	M16x1,5x85 mm	1
3	425004	Kaliper Vidası / Caliper Screw	M16x1,5x80 mm	1
4	423005	Körük (Kırmızı) / Bellows (Red)		1
5	428002	Fiber O-ring / Fiber O-Ring	Ø 36xØx50 mm	1
6	426002	Metal Barç / Caliper Pin Bush (Yellow)	Ø 36xØx52 mm	1
7	423038	Plastik Yüzük / Plastic Ring		1
8	425001	Perno Tapası / Bolt Plug	Ø 50x28 mm	1
9	428003	O-ring / O-Ring		1
10	429003	Perno Yüzüğü / Caliper Bolt Ring	Ø 26,5x11 mm	1
11	424003	Kaliper Pernosu / Caliper Bolt	Ø 36x114 mm	1

Tip / Application

ALL SB..., SN..., SERIES

421251

Kaliper Burcu / Caliper Pin Rubber Bush

SB6 - SB7 series

Orjinal No:

Cross No :



S.No.	Ekersan No.	Ürün Tanıtımı / Description	Ölçü/Dimension	Miktar/Qty.
1	421251	Kaliper Burcu / Caliper Pin Rubber Bush	Ø 39 mm	1

Tip / Application

ALL SB6..., SB7..., SERIES

421252

Lastikli Burç (Uzun) / Caliper Pin Rubber Bush (Long)

SB6 - SB7 series

Orjinal No:

Cross No :



Ø 35 mm

S.No.	Ekersan No.	Ürün Tanıtımı / Description	Ölçü/Dimension	Miktar/Qty.
1	421252	Lastikli Burç (Uzun) / Caliper Pin Rubber Bush (Long)	Ø 35xØx73 mm	1

Tip / Application

ALL SB6..., SB7..., SERIES

421253

Kaliper K r k Tamir Takımı / Caliper Dust Cover Set

SB6 - SB7 series

Orjinal No : 004206883 / 8108238805

Cross No : 38470861



S.No.	Ekersan No.	�r�n Tanımı / Description	�l�u/Dimension	Miktar/Qty.
1	428001	Kelece / Clamp	� 34x48x58 mm	1
2	423005	K�r�k (Kırmızı) / Bellows (Red)		1
3	428002	Fiber O-ring / Fiber O-Ring	� 34x48x58 mm	1
4	423006	K�r�k (Siyah) / Bellows (Black)		1

Tip / Application

ALL SB6..., SB7..., SERIES

421254

Kaliper Tutucu Tamir Takımı / Brake Pad Retainer Kit

SB6 - SB7 series

Orjinal No : 0280102580 / 3404380000

Cross No : 38470863



S.No.	Ekersan No.	�r�n Tanımı / Description	�l�u/Dimension	Miktar/Qty.
1	423006	K�r�k (Siyah) / Bellows (Black)		1
2	428001	Kelece / Clamp	� 34x48x58 mm	1

Tip / Application

ALL SB7..., SERIES

421255

Kaliper Perno Tamir Takımı / Caliper Pin Repair Kit

SB6 - SB7 series

Orjinal No : 1389428

Cross No : 19733882



S.No.	Ekersan No.	�r�n Tanımı / Description	�l�u/Dimension	Miktar/Qty.
1	424002	Kaliper Perno / Caliper Bolt	� 36x135 mm	1
2	424005	Kaliper Perno / Caliper Bolt	� 34x80 mm	1
3	425003	Kaliper Vidası / Caliper Screw	M16x1,5x140 mm	1
4	425001	Kaliper Vidası / Caliper Screw	M16x1,5x85 mm	1
5	426002	Metal Buru / Caliper Pin Bush (Yellow)	� 36x48x82 mm	1
6	423007	Plastik Buru / Plastic Bushing		1
7	423052	K�r�k (Siyah) / Bellows (Black)		1
8	426002	Metal Buru / Caliper Pin Bush (Yellow)	� 36x48x82 mm	1
9	428001	Kelece / Clamp	� 34x48x58 mm	1

Tip / Application

ALL SB7..., SERIES

KNOR

MAN / DAF

421256

Kaliper K6r6k Tamir Takimi / Caliper Dust Cover Set

SB6 - SB7 series

Original No: 82508228030 / 1440800

Cross No : 344730863



S.No.	Ekersan No.	6r6n Tanıtımı / Description	6l6u/Dimension	Miktar/Qty.
1	423053	Toz Lantıđı / Dust Cover		1
2	428001	Kedepce / Clamp	Ø 34x40x50 mm	1

Tip / Application

ALL SB7... SERIES

421100

Toz Lastığı Tamir Takimi / Caliper Tappet & Boot Kit (Ø 69 mm)

SN6 - SN7 - SK7 series

Original No: 42940413 / 0094202582 / 0094204082 / 0094204082 / 0094204282 / 01508120503 / 01508120503 / 3434383400 / 3622785 / 1895313

Cross No : 8301380 8300366 801603



S.No.	Ekersan No.	Ürün Tanıtımı / Description	Ölçü/Dimension	Miktar/Qty.
1	423001	Pabuçla Lastik / Trust Part With Bellow	Ø 69,00 mm	2
2	423002	Toz Lastığı / Shaft Body Dust Rubber	Ø 69,00 mm	2
3	426001	Metal Buçuk / Tappet Bush	Ø 18x16x18 mm	2

Tip / Application

ALL SN6... SN7... SK6... SK7... NA... SERIES

421101

Kaliper Toz Lastığı Tamir Takimi (Ø 69 mm) / Caliper Tappet & Boot Kit (Ø 69 mm)

SN6 - SN7 - SK7 series

Original No:

Cross No :



S.No.	Ekersan No.	Ürün Tanıtımı / Description	Ölçü/Dimension	Miktar/Qty.
1	423001	Pabuçla Lastik / Trust Part With Bellow	Ø 69,00 mm	2
2	426001	Metal Buçuk / Tappet Bush	Ø 18x16x18 mm	2

Tip / Application

ALL SN6... SN7... SK7... SERIES

421102

Toz Lastığı Tamir Takimi / Caliper Tappet & Boot Kit (Ø 69 mm)

SN6 - SN7 - SK7 series

Original No:

Cross No :



S.No.	Ekersan No.	Ürün Tanıtımı / Description	Ölçü/Dimension	Miktar/Qty.
1	423001	Pabuçla Lastik / Trust Part With Bellow	Ø 69,00 mm	1
2	426001	Metal Buçuk / Tappet Bush	Ø 18x16x18 mm	1

Tip / Application

ALL SN6... SN7... SK7... SERIES

KNOR

421104

Kaliper Toz Lastığı Tamir Takımı (Ø 69 mm) / Caliper Tappet & Boot Kit (Ø 69 mm)

SN6 - SN7 - SK7 series

Orjinal No:

Cross No :



S.No.	Ekersan No.	Ürün Tanımı / Description	Ölçü/Dimension	Miktar/Qty.
1	423001	Pabuçlu Lastik / Trust Part With Bellow	Ø 69,80 mm	2
2	423002	Toz Lastığı / Shaft Body Dust Rubber	Ø 69,80 mm	2
3	426001	Metal Burç / Tappet Bush	Ø 18x16x10 mm	2
4	423005	Kördük (Kırmızı) / Bellow (Red)		1
5	428002	Fiber O-ring / Fiber O-Ring	Ø 34x40x50 mm	1
6	423006	Kördük (Siyah) / Bellow (Black)		1
7	428001	Kedepce / Clamp	Ø 34x40x50 mm	1
8	429001	Perna Tapası / Bolt Plug	Ø 50x28 mm	1
9	428003	O-ring / O-Ring		1
10	423007	Plastik Burç / Plastic Bushing		1

Tip / Application

ALL SN6..., SN7..., SK7..., SERIES

KNOR

421105

Kaliper Toz Lastığı Tamir Takımı (Ø 69 mm) / Caliper Tappet & Boot Kit (Ø 69 mm)

SN6 - SN7 - SK7 series

Orjinal No:

Cross No :



S.No.	Ekersan No.	Ürün Tanımı / Description	Ölçü/Dimension	Miktar/Qty.
1	423001	Pabuçlu Lastik / Trust Part With Bellow	Ø 69,80 mm	2
2	426001	Metal Burç / Tappet Bush	Ø 18x16x10 mm	2
3	423005	Kördük (Kırmızı) / Bellow (Red)		1
4	428002	Fiber O-ring / Fiber O-Ring	Ø 34x40x50 mm	1
5	423006	Kördük (Siyah) / Bellow (Black)		1
6	428001	Kedepce / Clamp	Ø 34x40x50 mm	1
7	423007	Plastik Burç / Plastic Bushing		1

Tip / Application

ALL SN6..., SN7..., SK6..., SK7..., NA..., SERIES

KNOR

421121

Masura Bilya Yatagi / Caliper Lever (Açıklı : 0°)

SN6 - SN7 - SK7 series

Orjinal No:

Cross No :



S.No.	Ekersan No.	Ürün Tanımı / Description	Ölçü/Dimension	Miktar/Qty.
1	421121	Masura Bilya Yatagi / Caliper Lever (Açıklı : 0°)	Ad / Açıklı : 0°	1

Tip / Application

ALL SN6..., SN7..., SERIES

KNOR

421123

Masura Bilya Yatagi / Caliper Lever (Angel : 12°)

SN6 - SN7 - SK7 series

Orjinal No:

Cross No :



Tip / Application

ALL SN6..., SN7..., SERIES

S.No.	Ekarsan No.	Ürün Tanıtımı / Description	Ölçü/Dimension	Miktar/Qty.
1	421123	Masura Bilya Yatagi / Caliper Lever (Angel : 12°)	Açı / Angel : 12°	1

KNOR

421126

Masura Bilya Yatagi / Caliper Lever (Angel : 12°)

SN6 - SN7 - SK7 series

Orjinal No:

Cross No :



Tip / Application

ALL SK7..., SERIES

S.No.	Ekarsan No.	Ürün Tanıtımı / Description	Ölçü/Dimension	Miktar/Qty.
1	421126	Masura Bilya Yatagi / Caliper Lever (Angel : 12°)	Açı / Angel : 12°	1

KNOR

421127

Kaliper Ayar Mekanizması (Yaylı) / Caliper Adjusting Mechanism (With Spring)

SN6 - SN7 - SK7 series

Orjinal No:

Cross No :



Tip / Application

ALL SB6..., SB7..., SN6..., SN7..., SK7..., SERIES

S.No.	Ekarsan No.	Ürün Tanıtımı / Description	Ölçü/Dimension	Miktar/Qty.
1	421127	Ayar Mekanizması Yaylı / Caliper Adjusting Mechanism (With Spring)		1

421128

SN6 - SN7 - SK7 series



Kaliper Mekanizması Bilyalı / Caliper Adjusting Mechanism Shaft

Orjinal No:

Cross No :

S.No.	Ekersan No.	Ürün Tanıtımı / Description	Ölçü/Dimension	Miktar/Qty.
1	421128	Kaliper Mekanizması / Caliper Adjusting Mechanism Shaft		1

Tip / Application

ALL SB... SN... SK... SERIES

421132

SN6 - SN7 - SK7 series



Kaliper Dürbünü / Caliper Bridge Assembly

Orjinal No:

Cross No :

S.No.	Ekersan No.	Ürün Tanıtımı / Description	Ölçü/Dimension	Miktar/Qty.
1	421132	Kaliper Dürbünü / Caliper Bridge Assembly		1

Tip / Application

ALL SN6... SN7... SERIES

421133

SN6 - SN7 - SK7 series



Kaliper Dürbün Takımı / Caliper Bridge Assembly - Set

Orjinal No:

Cross No :

S.No.	Ekersan No.	Ürün Tanıtımı / Description	Ölçü/Dimension	Miktar/Qty.
1	421132	Kaliper Dürbünü / Caliper Bridge Assembly		1
2	421138	Kaliper Ayar Ovakası / Caliper Calibration Bolt		2
3	421148	Bilya Yatak Burcu / Caliper Bushing For Leveler		1

Tip / Application

ALL SN6... SN7... SERIES

KNOR

421134

Kaliper Dürbün Takimi / Caliper Bridge Assembly - Set

SN6 - SN7 - SK7 series

Orjinal No:

Cross No :



S.No.	Ekersan No.	Ürün Tanıtımı / Description	Ölçü/Dimension	Miktar/Qty.
1	421132	Kaliper Dürbünü / Caliper Bridge Assembly		1

Tip / Application

ALL SN6..., SN7..., SERIES

KNOR

421135

Kaliper Dürbünü / Caliper Bridge Assembly

SN6 - SN7 - SK7 series

Orjinal No:

Cross No :



S.No.	Ekersan No.	Ürün Tanıtımı / Description	Ölçü/Dimension	Miktar/Qty.
1	421135	Kaliper Dürbünü / Caliper Bridge Assembly		1

Tip / Application

ALL SN7..., SK7..., SERIES

KNOR

421136

Kaliper Dürbün Takimi / Caliper Bridge Assembly - Set

SN6 - SN7 - SK7 series

Orjinal No:

Cross No :



S.No.	Ekersan No.	Ürün Tanıtımı / Description	Ölçü/Dimension	Miktar/Qty.
1	421135	Kaliper Dürbünü / Caliper Bridge Assembly		1
2	421138	Kaliper Ayar Civatası / Caliper Calibration Bolt		2

Tip / Application

ALL SN7..., SK7..., SERIES

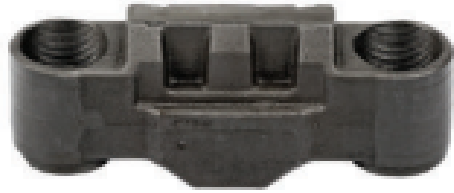
KNOR**421137****Kaliper Dürbün Takımı / Caliper Bridge Assembly - Set****SN6 - SN7 - SK7 series****Orjinal No:****Cross No :**

S.No.	Ekarsan No.	Ürün Tanıtımı / Description	Ölçü/Dimension	Miktar/Qty.
1	421137	Kaliper Dürbünü / Caliper Bridge Assembly		1

Tip / Application

ALL SK..., SL7..., SM7..., SERIES

KNOR**421138****Kaliper Ayar Civatası / Caliper Calibration Bolt****SN6 - SN7 - SK7 series****Orjinal No:****Cross No :**

13,2 mm

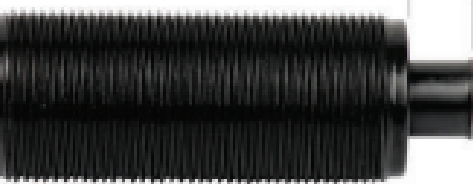

S.No.	Ekarsan No.	Ürün Tanıtımı / Description	Ölçü/Dimension	Miktar/Qty.
1	421138	Kaliper Ayar Civatası / Caliper Calibration Bolt		1

Tip / Application

ALL SB6..., SB6..., SB7..., SN6..., SN7..., SK7..., SERIES

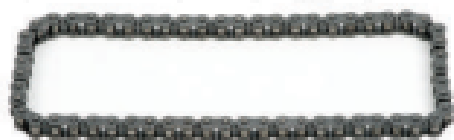
KNOR**421139****Kaliper Mekanizma Zinciri (29 Bakla) / Caliper Calibration Shaft Chain (29 Links)****SN6 - SN7 - SK7 series****Orjinal No:****Cross No :**

S.No.	Ekarsan No.	Ürün Tanıtımı / Description	Ölçü/Dimension	Miktar/Qty.
1	421139	Mekanizma Zinciri / Caliper Calibration Shaft Chain (29 Links)		1

Tip / Application

ALL SB6..., SB7..., SN6..., SN7..., SK7..., SERIES

KNOR

421142

Kaliper Ayar Dişlisi / Caliper Mechanism Gear

SN6 - SN7 - SK7 series

Orjinal No:

Cross No :



S.No.	Ekersan No.	Ürün Tanıtımı / Description	Ölçü/Dimension	Miktar/Qty.
1	421142	Kaliper Ayar Dişlisi / Caliper Mechanism Gear		1

Tip / Application

ALL SB6..., SB7..., SN6..., SN7..., SERIES

KNOR

421146

Kaliper Masura Bilya Takımı / Caliper Roller Bearing Set

SN6 - SN7 - SK7 series

Orjinal No:

Cross No :



S.No.	Ekersan No.	Ürün Tanıtımı / Description	Ölçü/Dimension	Miktar/Qty.
1	421146	Kaliper Masura Bilya / Caliper Roller Bearing		2

Tip / Application

ALL SN5..., SN6..., SN7..., SK7..., SERIES

KNOR

421147

Kaliper Masura Bilya Takımı / Caliper Roller Bearing Set

SN6 - SN7 - SK7 series

Orjinal No:

Cross No :



S.No.	Ekersan No.	Ürün Tanıtımı / Description	Ölçü/Dimension	Miktar/Qty.
1	421147	Kaliper Masura Bilya / Caliper Roller Bearing		2

Tip / Application

ALL SB5..., SB6..., SB7..., SN6..., SN7..., SK7..., SERIES

KNOR

421148

Kaliper Bilya Yatak Burcu / Caliper Bushing for Leveller

SN6 - SN7 - SK7 series

Orjinal No:

Cross No :



S.No.	Ekersan No.	Ürün Tanıtımı / Description	Ölçü/Dimension	Miktar/Qty.
1	421148	Bilya Yatak Burcu / Caliper Bushing for Leveller		1

Tip / Application

ALL SB6... SB7... SN6... SN7... SK7... SERIES

KNOR

421150

Kaliper Kapak Takimi Sac / Caliper Cover Kit Metal

SN6 - SN7 - SK7 series

Orjinal No:

Cross No :



S.No.	Ekersan No.	Ürün Tanıtımı / Description	Ölçü/Dimension	Miktar/Qty.
1	421150	Kaliper Kapak / Caliper Cover		1
2	429022	Kaliper Vidası / Screw	M8x1,25x20 mm	8

Tip / Application

ALL SN6... SN7... SK7... SERIES

KNOR

421151

Kaliper Plastik Kapak Sensörlü (3 Pinli) / Caliper Plastic Cover With Sensor (3 Lines)

SN6 - SN7 - SK7 series

Orjinal No:

Cross No :



S.No.	Ekersan No.	Ürün Tanıtımı / Description	Ölçü/Dimension	Miktar/Qty.
1	421151	Plastik Kapak Sensörlü / Caliper Plastic Cover With Sensor (3 Lines)		1

Tip / Application

ALL SB6... SB7... SN6... SN7... SK7... SERIES

KNOR

421152

SN6 - SN7 - SK7 series



Tip / Application

ALL SB6..., SB7..., SN6..., SN7..., SK7..., SERIES

Kaliper Plastik Kapak Sensörlü (2 Pinli) / Caliper Plastic Cover With Sensor (2 Lines)

Orjinal No:

Cross No :

S.No.	Ekersan No.	Ürün Tanıtımı / Description	Ölçü/Dimension	Miktar/Qty.
1	421152	Plastik Kapak Sensörlü / Caliper Plastic Cover With Sensor (2 Lines)		1

KNOR

421153

SN6 - SN7 - SK7 series



Tip / Application

ALL SB6..., SB7..., SN6..., SN7..., SK7..., SERIES

Kaliper Plastik Kapak Sensörsüz / Caliper Plastic Cover Without Sensor

Orjinal No:

Cross No :

S.No.	Ekersan No.	Ürün Tanıtımı / Description	Ölçü/Dimension	Miktar/Qty.
1	421153	Plastik Kapak Sensörsüz / Caliper Plastic Cover Without Sensor		1

KNOR

421161

SN6 - SN7 - SK7 series



Tip / Application

MERCEDES

Kaliper Perno Tamir Takımı / Caliper Pin Repair Kit

Orjinal No: 0004204.382

Cross No : 8801915

S.No.	Ekersan No.	Ürün Tanıtımı / Description	Ölçü/Dimension	Miktar/Qty.
1	424003	Kaliper Peması / Caliper Bolt	Ø 36x114 mm	1
2	424004	Kaliper Peması / Caliper Bolt	Ø 32x88 mm	1
3	425001	Kaliper Vidası / Caliper Screw	M16x1,5x80 mm	1
4	425004	Kaliper Vidası / Caliper Screw	M16x1,5x80 mm	1
5	423005	Kirik (Kırmızı) / Bellow (Red)		1
6	428002	Fiber O-ring / Fiber O-Ring	Ø 14xØx58 mm	1
7	426002	Metal Buçuk / Caliper Pin Bush (Yellow)	Ø 16xØx82 mm	1
8	421162	Lastikli Buçuk (Uzun) / Caliper Pin Rubber Bush (Long)	Ø 18xØx73 mm	1
9	421161	Lastikli Buçuk (Kısa) / Caliper Pin Rubber Bush - (Short)	Ø 18xØx55 mm	1

421165

Kaliper Perno & Lastikli Burç (Kısa) / Caliper Pin & Bush (Short)

SN6 - SN7 - SK7 series

Orjinal No:

Cross No :



S.No.	Ekersan No.	Ürün Tanıtım / Description	Ölçü/Dimension	Miktar/Qty.
1	429004	Kaliper Pernosu / Caliper Bolt	Ø 32x80 mm	1
2	421161	Lastikli Burç (Kısa) / Caliper Pin Rubber Bush - (Short)	Ø 39x40x55 mm	1

Tip / Application

421166

Kaliper Perno Tamir Takımı / Caliper Pin Repair Kit

SN6 - SN7 - SK7 series

Orjinal No: 0004203982 / 82506226023 / 42518902 / 0260106240

Cross No : K880375



S.No.	Ekersan No.	Ürün Tanıtım / Description	Ölçü/Dimension	Miktar/Qty.
1	429004	Kaliper Pernosu / Caliper Bolt	Ø 32x80 mm	1
2	425001	Kaliper Vidası / Caliper Screw	M16x1,5x85 mm	1
3	425004	Kaliper Vidası / Caliper Screw	M16x1,5x80 mm	1
4	429005	Könk (Kırmızı) / Bellow (Red)		1
5	428002	Fiber O-ring / Fiber O-Ring	Ø 34x40x50 mm	1
6	426002	Metel Burç / Caliper Pin Bush (Yellow)	Ø 36x40x82 mm	1
7	421162	Lastikli Burç (Uzun) / Caliper Pin Rubber Bush (Long)	Ø 39x40x73 mm	1
8	429001	Perno Tapası / Bolt Plug	Ø 50x28 mm	1
9	428003	O-ring / O-Ring		1
10	429003	Perno Yüzüğü / Caliper Bolt Ring	Ø 26,5x11 mm	1
11	429003	Kaliper Pernosu / Caliper Bolt	Ø 36x114 mm	1

Tip / Application

ALL SB5..., SB6..., SB7..., SN6..., SN7..., SERIES

421167

Kaliper Perno Tamir Takımı / Caliper Pin Repair Kit

SN6 - SN7 - SK7 series

Orjinal No: 0004203982 / 82506226023 / 42518902 / 0260106240 / 3404300200

Cross No : K880402



S.No.	Ekersan No.	Ürün Tanıtım / Description	Ölçü/Dimension	Miktar/Qty.
1	429003	Kaliper Pernosu / Caliper Bolt	Ø 36x114 mm	1
2	429004	Kaliper Pernosu / Caliper Bolt	Ø 32x80 mm	1
3	425001	Kaliper Vidası / Caliper Screw	M16x1,5x80 mm	1
4	429004	Kaliper Vidası / Caliper Screw	M16x1,5x80 mm	1
5	429005	Könk (Kırmızı) / Bellow (Red)		1
6	428002	Fiber O-ring / Fiber O-Ring	Ø 34x40x50 mm	1
7	426002	Metel Burç / Caliper Pin Bush (Yellow)	Ø 36x40x82 mm	1
8	421162	Lastikli Burç (Uzun) / Caliper Pin Rubber Bush (Long)	Ø 39x40x73 mm	1
9	429002	Perno Tapası / Bolt Plug	Ø 40x13 mm	1
10	429003	Perno Yüzüğü / Caliper Bolt Ring	Ø 26,5x11 mm	1

Tip / Application

ALL SN6..., SN7..., NA7..., SERIES

421168

Kaliper Perno Tamir Takımı / Caliper Pin Repair Kit

SN6 - SN7 - SK7 series

Orjinal No: 098100510 / 342481300

Cross No : 830688



Ø 32 x 80 mm

80 mm

Ø 39 mm

S.No.	Ekersan No.	Ürün Tanıtımı / Description	Ölçü/Dimension	Miktar/Qty.
1	425004	Kaliper Vidası / Caliper Screw	M16x1,5x80 mm	1
2	421182	Lastikli Buç (Uzun) / Caliper Pin Rubber Bush (Long)	Ø 39x48x73 mm	1
3	429003	Perno Yüzüğü / Caliper Bolt Ring	Ø 26,5x11 mm	1
4	424004	Kaliper Perno / Caliper Bolt	Ø 32x88 mm	1

Tip / Application

ALL S85..., S86..., S87..., SN6..., SN7..., SK7... SERIES

421172

Kaliper Perno Tamir Takımı / Caliper Pin Repair Kit

SN6 - SN7 - SK7 series

Orjinal No: 0004209002 / 3434381500

Cross No : 8304190 8310366



Ø 36 x 114 mm

Ø 36 x 64 mm

85 mm

70 mm

S.No.	Ekersan No.	Ürün Tanıtımı / Description	Ölçü/Dimension	Miktar/Qty.
1	424003	Kaliper Perno / Caliper Bolt	Ø 36x114 mm	1
2	424006	Kaliper Perno / Caliper Bolt	Ø 36x64 mm	1
3	425001	Kaliper Vidası / Caliper Screw	M16x1,5x85 mm	1
4	425005	Kaliper Vidası / Caliper Screw	M16x1,5x70 mm	1
5	423005	Körük (Kırmızı) / Bellow (Red)		2
6	428002	Fiber O-ring / Fiber O-Ring	Ø 34x48x58 mm	2
7	426005	Metal Buç / Bushing	Ø 36x48x28 mm	1
8	429004	Perno Tapası / Bolt Flange	Ø 48x25 mm	1
9	429012	Perno Tapası / Bolt Flange	Ø 48x18 mm	1

Tip / Application

ALL SK... SERIES

421173

Kaliper Perno Tamir Takımı / Caliper Pin Repair Kit

SN6 - SN7 - SK7 series

Orjinal No:

Cross No :



Ø 36 x 64 mm

70 mm

S.No.	Ekersan No.	Ürün Tanıtımı / Description	Ölçü/Dimension	Miktar/Qty.
1	424006	Kaliper Perno / Caliper Bolt	Ø 36x64 mm	1
2	425005	Kaliper Vidası / Caliper Screw	M16x1,5x70 mm	1
3	423005	Körük (Kırmızı) / Bellow (Red)		1
4	428002	Fiber O-ring / Fiber O-Ring	Ø 34x48x58 mm	1
5	426005	Metal Buç / Bushing	Ø 36x48x28 mm	1

Tip / Application

ALL SN7..., SK7... SERIES

421174

Kaliper Perno Kapak Takımı / Caliper Pin Cap Set

SN6 - SN7 - SK7 series

Orjinal No: 820828025

Cross No : K081381



S.No.	Ekersan No.	Ürün Tanıtımı / Description	Ölçü/Dimension	Miktar/Qty.
1	428001	Kaliper / Clamp	Ø 34xØx50 mm	6
2	429001	Perno Tapesi / Bolt Plug	Ø 50x28 mm	6
3	428003	O-ring / O-Ring		6
4	423006	Körük (Siyah) / Bellow (Black)		6

Tip / Application

ALL SB..., SN..., SK... SERIES

421175

Kaliper Ayar Mekanizması Kapak Takımı / Caliper Adjusting Mechanism Cap Set

SN6 - SN7 - SK7 series

Orjinal No: 0004234887 / 00500226021

Cross No : K080029



S.No.	Ekersan No.	Ürün Tanıtımı / Description	Ölçü/Dimension	Miktar/Qty.
1	421149	Mekanizma Ayar Somunu / Adjusting Nut		10
2	423011	Plastik Kapak / Plastic Cover	Ø 38 mm	10

Tip / Application

ALL SB5..., SN5..., SB6..., SB7..., SN6..., SN7..., SK7..., SERIES

421176

Kaliper Ayar Mekanizması Kapak Takımı / Caliper Adjusting Mechanism Cap Set

SN6 - SN7 - SK7 series

Orjinal No:

Cross No : K082962



S.No.	Ekersan No.	Ürün Tanıtımı / Description	Ölçü/Dimension	Miktar/Qty.
1	421149	Mekanizma Ayar Somunu / Adjusting Nut		10
2	423012	Plastik Kapak / Plastic Cover	Ø 35 mm	10

Tip / Application

ALL SB5..., SN5..., SB6..., SB7..., SN6..., SN7..., SK7..., SERIES

421179

Kaliper Balata Tutucu Tamir Takımı / Caliper Pad Retainer Repair Kit

SN6 - SN7 - SK7 series

Orjinal No: 000A200802

Cross No : "1971208430679084197120861"



S.No.	Ekansan No.	Ürün Tanımı / Description	Ölçü/Dimension	Miktar/Qty.
1	422004	Pin / Pin		1
2	422004	PA / Washer		1
3	428005	Kopilya / Cotter Pin		1
4	428006	Kaliper Tutucu / Brake Pad Retainer		1

Tip / Application

ALL SB..., SN..., SK..., SERIES

421180

Balata Tutucu & Ayar Somun Takımı / Pad Retainer & Mechanism Adapter Kit

SN6 - SN7 - SK7 series

Orjinal No:

Cross No :



S.No.	Ekansan No.	Ürün Tanımı / Description	Ölçü/Dimension	Miktar/Qty.
1	420149	Mekanizma Ayar Somunu / Adjusting Nut		1
2	422004	Pin / Pin		2
3	428004	PA / Washer		2
4	428005	Kopilya / Cotter Pin		2
5	423010	Plastik Kapak / Plastic Cover	Ø 38 mm	2

Tip / Application

ALL SB..., SN..., SK..., SERIES

421186

Masura Bilya Yatagi / Caliper Lever (Açıkl : 0° - 113 mm)

SN6 - SN7 - SK7 series

Orjinal No:

Cross No :



S.No.	Ekansan No.	Ürün Tanımı / Description	Ölçü/Dimension	Miktar/Qty.
1	421186	Masura Bilya Yatagi / Caliper Lever (Açıkl : 0° - 113 mm)	Aç / Açıkl : 0°	1

Tip / Application

ALL SK7... SERIES

KNOR

421191

Kaliper Perno & Lastikli Burç (Uzun) / Caliper Pin & Bush (Long)

SN6 - SN7 - SK7 series

Orjinal No:

Cross No : K090697



S.No.	Ekersan No.	Ürün Tanıtımı / Description	Ölçü/Dimension	Miktar/Qty.
1	421182	Lastikli Burç (Uzun) / Caliper Pin Rubber Bush (Long)	Ø 39x80x73 mm	1
2	424004	Kaliper Pernosu / Caliper Bolt	Ø 32x80 mm	1

Tip / Application

ALL SBS..., SN5..., SB6..., SB7..., SN6..., SN7..., SK7..., SERIES

KNOR

421192

Kaliper Ayar Mekanizması Kapak Takımı / Caliper Adjusting Mechanism Cap Set

SN6 - SN7 - SK7 series

Orjinal No: 81508228024

Cross No : K090945



S.No.	Ekersan No.	Ürün Tanıtımı / Description	Ölçü/Dimension	Miktar/Qty.
1	421149	Mekanizma Ayar Somunu / Adjusting Nut		10
2	428037	Kaliper Keçesi / Caliper Seal		10
3	423011	Plastik Kapak / Plastic Cover	Ø 38 mm	10

Tip / Application

ALL SBS..., SN5..., SB6..., SB7..., SN6..., SN7..., SK7..., SERIES

KNOR

421195

Mekanizma Ayar Somunu Seti / Adjusting Nut - Set

SN6 - SN7 - SK7 series

Orjinal No:

Cross No : J001548



S.No.	Ekersan No.	Ürün Tanıtımı / Description	Ölçü/Dimension	Miktar/Qty.
1	421149	Mekanizma Ayar Somunu / Adjusting Nut		10

Tip / Application

ALL SB..., SN..., SK..., SERIES

KNOR

421196

Balata Tutucu & Ayar Somun Takımı / Pad Retainer & Mechanism Adapter Kit

SN6 - SN7 - SK7 series

Orjinal No:

Cross No :



S.No.	Ekersan No.	Ürün Tanıtımı / Description	Ölçü/Dimension	Miktar/Qty.
1	421149	Mekanizma Ayar Somunu / Adjusting Nut		1
2	422004	Pin / Pin		2
3	428004	Pul / Washer		2
4	428005	Kopilya / Cotter Pin		2
5	423012	Plastik Kapak / Plastic Cover	Ø 35 mm	2

Tip / Application

ALL SB... SN... SK... SERIES

KNOR

421197

Kaliper Perno Tamir Takımı / Caliper Pin Repair Kit

SN6 - SN7 - SK7 series

Orjinal No: 056020000

Cross No :



S.No.	Ekersan No.	Ürün Tanıtımı / Description	Ölçü/Dimension	Miktar/Qty.
1	425004	Kaliper Vidası / Caliper Screw	M16x1,5x80 mm	1
2	421252	Lastik Burç (Uzun) / Caliper Pin Rubber Bush (Long)	Ø 35x48x73 mm	1
3	429003	Perno Yüzüğü / Caliper Bolt Ring	Ø 26,5x11 mm	1
4	424004	Kaliper Pernosu / Caliper Bolt	Ø 32x80 mm	1

Tip / Application

ALL SB5... SN5... SB6... SB7... SN6... SN7... SK7... SERIES

KNOR

421198

Kaliper Plastik Kapak Sensörlü (3 Pinli) / Caliper Plastic Cover With Sensor (3 Lines)

SN6 - SN7 - SK7 series

Orjinal No:

Cross No :



S.No.	Ekersan No.	Ürün Tanıtımı / Description	Ölçü/Dimension	Miktar/Qty.
1	421298	Plastik Kapak Sensörlü / Caliper Plastic Cover With Sensor (3 Lines)		1

Tip / Application

ALL SB6... SB7... SN6... SN7... SK7... SERIES

KNOR

421200

Kaliper Plastik Kapak Sensörsüz / Caliper Plastic Cover Without Sensor

SN6 - SN7 - SK7 series

Orjinal No:

Cross No :



S.No.	Ekersan No.	Ürün Tanıtımı / Description	Ölçü/Dimension	Miktar/Qty.
1	421200	Plastik Kapak Sensörsüz / Caliper Plastic Cover Without Sensor		1

Tip / Application

ALL SB6..., SB7..., SN6..., SN7..., SK7..., SERIES

KNOR

421201

Kaliper Plastik Kapak Sensörlü (2 Pinli) / Caliper Plastic Cover With Sensor (2 Lines)

SN6 - SN7 - SK7 series

Orjinal No:

Cross No :



S.No.	Ekersan No.	Ürün Tanıtımı / Description	Ölçü/Dimension	Miktar/Qty.
1	421201	Plastik Kapak Sensörlü / Caliper Plastic Cover With Sensor		1

Tip / Application

ALL SB6..., SB7..., SN6..., SN7..., SK7..., SERIES

KNOR

421202

Kaliper Tapa Seti / Caliper Cap Set

SN6 - SN7 - SK7 series

Orjinal No:

Cross No :



S.No.	Ekersan No.	Ürün Tanıtımı / Description	Ölçü/Dimension	Miktar/Qty.
1	421202	Kaliper Tapa Seti / Caliper Plug		5

Tip / Application

ALL SN5..., SB5..., SB6..., SB7..., SN6..., SN7..., SK7..., SERIES

KNOR

421203

Kaliper Balata Tutucu Tamir Takımı / Caliper Pad Retainer Repair Kit

SN6 - SN7 - SK7 series

Original No:

Cross No :

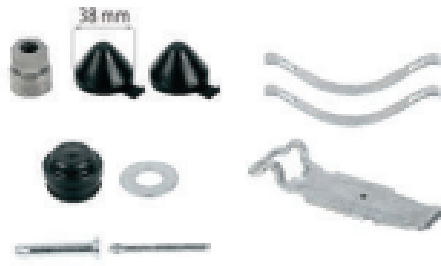

S.No.	Ekersan No.	Ürün Tanıtımı / Description	Ölçü/Dimension	Miktar/Qty.
1	420149	Mekanizma Ayar Somunu / Adjusting Nut		1
2	428007	Kaliper Keçesi / Caliper Seal		1
3	428006	Kaliper Tutucu / Brake Pad Retainer		1
4	422004	Pin / Pin		1
5	428004	Pa / Washer		1
6	428005	Kopçiya / Cotter Pin		1
7	423011	Plastik Kapak / Plastic Cover	Ø 38 mm	2

Tip / Application

ALL SB5..., SM5..., SB6..., SB7..., SN6..., SN7..., SK7..., SERIES

KNOR

421223

Masura Bilya Yatagi / Caliper Lever (Angle : 12°)

SN6 - SN7 - SK7 series

Original No:

Cross No :



S.No.	Ekersan No.	Ürün Tanıtımı / Description	Ölçü/Dimension	Miktar/Qty.
1	421223	Masura Bilya Yatagi / Caliper Lever (Angle : 12°)	Açı / Angle : 12°	1

Tip / Application

ALL SN6..., SN7..., SERIES

KNOR

421224

Masura Bilya Yatagi / Caliper Lever (Angle : 12°)

SN6 - SN7 - SK7 series

Original No:

Cross No :



S.No.	Ekersan No.	Ürün Tanıtımı / Description	Ölçü/Dimension	Miktar/Qty.
1	421224	Masura Bilya Yatagi / Caliper Lever (Angle : 12°)	Açı / Angle : 12°	1

Tip / Application

ALL SN6..., SN7..., SERIES

KNOR

421225

Masura Bilya Yatagi / Caliper Lever

SN6 - SN7 - SK7 series

Orjinal No:

Cross No :

S.No.	Ekersan No.	Ürün Tanıtımı / Description	Ölçü/Dimension	Miktar/Qty.
1	421225	Masura Bilya Yatagi / Caliper Lever		1



Tip / Application

ALL SK7... SERIES

KNOR

421226

Masura Bilya Yatagi / Caliper Lever

SN6 - SN7 - SK7 series

Orjinal No:

Cross No :

S.No.	Ekersan No.	Ürün Tanıtımı / Description	Ölçü/Dimension	Miktar/Qty.
1	421226	Masura Bilya Yatagi / Caliper Lever		1



Tip / Application

ALL SN6... SN7... SERIES

KNOR

421227

Kaliper Kapak Takimi Sac / Caliper Cover Kit Metal

SN6 - SN7 - SK7 series

Orjinal No:

Cross No :

S.No.	Ekersan No.	Ürün Tanıtımı / Description	Ölçü/Dimension	Miktar/Qty.
1	420054	Kaliper Kapak / Caliper Cover		1
2	425022	Kaliper Vidası / Screw	M8x1,25x20 mm	6



Tip / Application

ALL SN6... SN7... SK7... SERIES

KNOR

421228

Plastik Kapak Sensörsüz / Caliper Plastic Cover Without Sensor

SN6 - SN7 - SK7 series

Original No:

Cross No :



S.No.	Ekersan No.	Ürün Tanıtımı / Description	Ölçü/Dimension	Miktar/Qty.
1	421228	Plastik Kapak Sensörsüz / Caliper Plastic Cover Without Sensor		1

Tip / Application

ALL SN6..., SN7..., SK7..., SERIES

KNOR

421229

Plastik Kapak Sensörlü / Caliper Plastic Cover With Sensor (2 Lines)

SN6 - SN7 - SK7 series

Original No:

Cross No :



S.No.	Ekersan No.	Ürün Tanıtımı / Description	Ölçü/Dimension	Miktar/Qty.
1	421229	Plastik Kapak Sensörlü / Caliper Plastic Cover With Sensor (2 Lines)	2 Lines	1

Tip / Application

ALL SN6..., SN7..., SK7..., SERIES

KNOR

421230

Kaliper Semeeri Sağ / Caliper Carrier (Right)

SN6 - SN7 - SK7 series

Original No: 020422800

Cross No :



S.No.	Ekersan No.	Ürün Tanıtımı / Description	Ölçü/Dimension	Miktar/Qty.
1	421230	Kaliper Semeeri Sağ / Caliper Carrier (Right)		1

Tip / Application

421231

Kaliper Semeeri Sol / Caliper Carrier (Left)

SN6 - SN7 - SK7 series

Orjinal No: 000421231

Cross No :



S.No.	Ekersan No.	Ürün Tanıtımı / Description	Ölçü/Dimension	Miktar/Qty.
1	421231	Kaliper Semeeri Sol / Caliper Carrier (Left)		1

Tip / Application

421232

Kaliper Semeeri / Caliper Carrier (22,5°)

SN6 - SN7 - SK7 series

Orjinal No:

Cross No :



S.No.	Ekersan No.	Ürün Tanıtımı / Description	Ölçü/Dimension	Miktar/Qty.
1	421232	Kaliper Semeeri / Caliper Carrier (22,5°)	22,5°	1

Tip / Application

421257

Kaliper Perno Tamir Takimi / Caliper Pin Repair Kit

SN6 - SN7 - SK7 series

Orjinal No:

Cross No : 0048331 K50



S.No.	Ekersan No.	Ürün Tanıtımı / Description	Ölçü/Dimension	Miktar/Qty.
1	424003	Kaliper Pernosu / Caliper Bolt	Ø 36x114 mm	1
2	424004	Kaliper Pernosu / Caliper Bolt	Ø 32x80 mm	1
3	425001	Kaliper Vidası / Caliper Screw	M16x1,5x80 mm	1
4	425004	Kaliper Vidası / Caliper Screw	M16x1,5x80 mm	1
5	426002	Metel Barç / Caliper Pin Bush (Yellow)	Ø 36xØ32 mm	1
6	421381	Lastik Barç (Kısa) / Caliper Pin Rubber Bush - (Short)	Ø 36xØ32 mm	1
7	423005	Konak (Kırmızı) / Bellow (Red)		1
8	428001	Perno Tapası / Bolt Plug	Ø 50x28 mm	1
9	428003	O-ring / O-Ring		1

Tip / Application

ALL SN6..., SN7..., SERIES

KNOR

421137

Kaliper Dürbün Takımı / Caliper Bridge Assembly - Set

SL7 - SM7 series

Orjinal No:

Cross No :



S.No.	Ekersan No.	Ürün Tanıtımı / Description	Ölçü/Dimension	Miktar/Qty.
1	421135	Kaliper Dürbünü / Caliper Bridge Assembly		1

Tip / Application

ALL SK..., SL7..., SM7..., SERIES

KNOR

421163

Kaliper Perno Tamir Takımı / Caliper Pin Repair Kit

SL7 - SM7 series

Orjinal No:

Cross No :



S.No.	Ekersan No.	Ürün Tanıtımı / Description	Ölçü/Dimension	Miktar/Qty.
1	424003	Kaliper Perno / Caliper Bolt	Ø 36x114 mm	1
2	424004	Kaliper Perno / Caliper Bolt	Ø 32x88 mm	1
3	425001	Kaliper Vidası / Caliper Screw	M16x1,5x85 mm	1
4	425004	Kaliper Vidası / Caliper Screw	M16x1,5x80 mm	1
5	421181	Lastikli Buçuk (Kısa) / Caliper Pin Rubber Bush - (Short)	Ø 39x8x55 mm	1

Tip / Application

ALL SL7..., SM7..., SERIES

KNOR

421184

Masura Bilya Yatagi / Caliper Lever

SL7 - SM7 series

Orjinal No:

Cross No :



S.No.	Ekersan No.	Ürün Tanıtımı / Description	Ölçü/Dimension	Miktar/Qty.
1	421184	Masura Bilya Yatagi / Caliper Lever		1

Tip / Application

ALL SL7..., SM7..., SERIES

KNOR

421235

Toz Lastığı Tamir Takımı / Caliper Tappet & Boot Kit

SL7 - SM7 series

Orjinal No:

Cross No :

S.No.	Ekersan No.	Ürün Tanımı / Description	Ölçü/Dimension	Miktar/Qty.
1	43069	Pabuçla Lastik / Trust Part With Bellow	Ø 54 mm - Ø 60,80 mm	2
2	423002	Toz Lastığı / Shaft Body Dust Rubber	Ø 60,80 mm	2
3	426043	Mecol Burç / Tappet Bush	Ø 17x15x07 mm	2

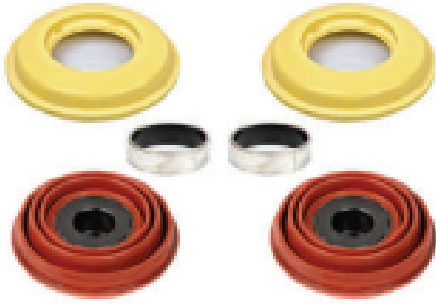

Tip / Application

ALL SL7..., SM7..., SERIES

KNOR

421236

Kaliper Ayar Civatası / Caliper Calibration Bolt

SL7 - SM7 series

Orjinal No:

Cross No :

S.No.	Ekersan No.	Ürün Tanımı / Description	Ölçü/Dimension	Miktar/Qty.
1	421236	Kaliper Ayar Civatası / Caliper Calibration Bolt	9,50 mm	1

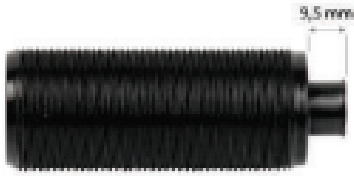

Tip / Application

ALL SL7..., SM7..., SERIES

KNOR

421237

Ayar Mekanizması Yaysız / Caliper Adjusting Mechanism (Without Spring)

SL7 - SM7 series

Orjinal No:

Cross No :

S.No.	Ekersan No.	Ürün Tanımı / Description	Ölçü/Dimension	Miktar/Qty.
1	421237	Ayar Mekanizması Yaysız / Caliper Adjusting Mechanism (Without Spring)		1



Tip / Application

ALL SL7..., SM7..., SERIES

KNOR

421238

Kaliper Masura Bilya Takimi / Caliper Roller Bearing Set

SL7 - SM7 series

Orjinal No:

Cross No :



S.No.	Ekarsan No.	Ürün Tanıtımı / Description	Ölçü/Dimension	Miktar/Qty.
1	423549	Kaliper Masura Bilya / Caliper Roller Bearing		2

Tip / Application

ALL SL7... SM7... SERIES

KNOR

421239

Kaliper Balata Tutucu Tamir Takimi / Caliper Pad Retainer Repair Kit

SL7 - SM7 series

Orjinal No:

Cross No :



S.No.	Ekarsan No.	Ürün Tanıtımı / Description	Ölçü/Dimension	Miktar/Qty.
1	428066	Kaliper Tutucu / Brake Pad Retainer		1
2	422004	Pin / Pin		1
3	428005	Kopilya / Cotter Pin		1
4	421127	Ayar Mekanizması/Yaylı / Caliper Adjusting Mechanism (With Spring)		1

Tip / Application

ALL SL7... SM7... SERIES

KNOR

421250

Kaliper Perno Tamir Takimi / Caliper Pin Repair Kit

SL7 - SM7 series

Orjinal No:

Cross No :



S.No.	Ekarsan No.	Ürün Tanıtımı / Description	Ölçü/Dimension	Miktar/Qty.
1	424003	Kaliper Pernosu / Caliper Bolt	Ø 36 x 114 mm	1
2	424004	Kaliper Pernosu / Caliper Bolt	Ø 32 x 80 mm	1
3	425001	Kaliper Vidası / Caliper Screw	M16x1,5x85 mm	1
4	425004	Kaliper Vidası / Caliper Screw	M16x1,5x80 mm	1
5	423005	Körük (Kırmızı) / Bellow (Red)		1
6	428002	Fiber O-ring / Fiber O-Ring	Ø 34xØ150 mm	1
7	426002	Metal Buç / Caliper Pin Bush (Yellow)	Ø 36xØ182 mm	1
8	421181	Latiksli Buç (Kısa) / Caliper Pin Rubber Bush - (Short)	Ø 36xØ183 mm	1

Tip / Application

MERITOR

MERITOR**422027**

Ayar Dişlisi BÜyük Sağ / Caliper Adjusting Gear (Big Right)

D3 series

Orjinal No:

Cross No :



S.No.	Ekersan No.	Ürün Tanıtımı / Description	Ölçü/Dimension	Miktar/Qty.
1	422027	Ayar Dişlisi BÜyük Sağ / Caliper Adjusting Gear (Big Right)		1

Tip / Application

IRG 524, 526, 528, 532, 562, 622

MERITOR**422028**

Ayar Dişlisi BÜyük Sol / Caliper Adjusting Gear (Big Left)

D3 series

Orjinal No:

Cross No :



S.No.	Ekersan No.	Ürün Tanıtımı / Description	Ölçü/Dimension	Miktar/Qty.
1	422028	Ayar Dişlisi BÜyük Sol / Caliper Adjusting Gear (Big Left)		1

Tip / Application

IRG 525, 527, 529, 533, 563, 623

MERITOR**422029**

Ayar Dişlisi KÜçük / Caliper Adjusting Gear Small

D3 series

Orjinal No:

Cross No :



S.No.	Ekersan No.	Ürün Tanıtımı / Description	Ölçü/Dimension	Miktar/Qty.
1	422029	Ayar Dişlisi KÜçük / Caliper Adjusting Gear Small		1

Tip / Application

D3

MERITOR

422031

Circir Ayar Civatası / Caliper Adjuster Bolt

D3 series

Orjinal No:

Cross No :



Tip / Application

D3

S.No.	Ekersan No.	Ürün Tanıtımı / Description	Ölçü/Dimension	Miktar/Qty.
1	422031	Circir Ayar Civatası / Caliper Adjuster Bolt	M18x1,5x50 mm	1

MERITOR

422032

Kaliper Masura Bilya / Caliper Roller Bearing

D3 series

Orjinal No:

Cross No :



Tip / Application

LRG 524, 525, 526, 527, 528, 529, 532, 533, 622, 623

S.No.	Ekersan No.	Ürün Tanıtımı / Description	Ölçü/Dimension	Miktar/Qty.
1	422032	Kaliper Masura Bilya / Caliper Roller Bearing		1

MERITOR

424165

Kaliper Tamir Takimi Komple (Arka Sol) / Caliper Repair Kit Full (Rear Left)

D3 series

Orjinal No:

Cross No :



Tip / Application

LRG 622

S.No.	Ekersan No.	Ürün Tanıtımı / Description	Ölçü/Dimension	Miktar/Qty.
1	424076	Frezeli Mil (Sol-Arka) / Shaft Gear Spine-Long (Rear-Left)	26 Teeth	1
2	422028	Ayar Dişli Büyük Sol / Caliper Adjusting Gear (Big Left)		1
3	422029	Ayar Dişli Küçük / Caliper Adjusting Gear Small		1
4	424077	Kaliper Tane Bilya Takımı / Caliper Ball Bearing-Set	Ø 12 mm	1
5	422032	Kaliper Masura Bilya / Caliper Roller Bearing		1
6	423027	Teç Kapağı / Dust Cover		1
7	428019	Kaliper Dalgalı Rıya / Caliper Wavy Shim		1
8	423023	Pirna Kapağı / Dust Plug	Ø 20x12 mm	1
9	423030	Civata Lastiği / Screw Rubber		1
10	426025	Metal Burç / Bushing	Ø 58x54x28 mm	1
11	423028	Plastik Kapak Büyük / Plastic Cap-Big		1
12	423029	Plastik Kapak Küçük / Plastic Cap-Small		1

424166

Kaliper Tamir Takimi Komple (Arka Sağ) / Caliper Repair Kit Full (Rear Right)

D3 series

Orjinal No:

Cross No :



S.No.	Ekersan No.	Ürün Tanıtımı / Description	Ölçü/Dimension	Miktar/Qty.
1	424174	Frezeli Mil (Sağ-Arka) / Shaft Gear Spline-Long (Rear-Right)	26 teeth	1
2	422027	Ayar Dişlisi Büyük Sağ / Caliper Adjusting Gear (Big Right)		1
3	422029	Ayar Dişlisi Küçük / Caliper Adjusting Gear Small		1
4	424177	Kaliper Tane Bilya Takımı / Caliper Ball Bearing-Set	Ø 12 mm	1
5	422032	Kaliper Masura Bilya / Caliper Roller Bearing		1
6	423027	Toz Lastiği / Dust Cover		1
7	428019	Kaliper Dalgıllı Raynol / Caliper Wavy Shim		1
8	422031	Çırcı Ayar Çıvatası / Caliper Adjuster Bolt	M10x1,5x50 mm	1
9	423030	Çivata Lastiği / Screw Rubber		1
10	426025	Metal Bar / Bushing	Ø 50x55x20 mm	1
11	423028	Plastik Kapak Büyük / Plastic Cap-Big		1
12	423029	Plastik Kapak Küçük / Plastic Cap-Small		1

Tip / Application

LRG 623

424167

Kaliper Tamir Takimi Komple (Ön Sol) / Caliper Repair Kit Full (Front Left)

D3 series

Orjinal No:

Cross No :



S.No.	Ekersan No.	Ürün Tanıtımı / Description	Ölçü/Dimension	Miktar/Qty.
1	424174	Frezeli Mil (Sol-Ön) / Shaft Gear Spline-Short (Front-Left)	26 teeth	1
2	422028	Ayar Dişlisi Büyük Sol / Caliper Adjusting Gear (Big Left)		1
3	422029	Ayar Dişlisi Küçük / Caliper Adjusting Gear Small		1
4	424177	Kaliper Tane Bilya Takımı / Caliper Ball Bearing-Set	Ø 12 mm	1
5	422032	Kaliper Masura Bilya / Caliper Roller Bearing		1
6	423027	Toz Lastiği / Dust Cover		1
7	428019	Kaliper Dalgıllı Raynol / Caliper Wavy Shim		1
8	422031	Çırcı Ayar Çıvatası / Caliper Adjuster Bolt	M10x1,5x50 mm	1
9	423030	Çivata Lastiği / Screw Rubber		1
10	426025	Metal Bar / Bushing	Ø 50x55x20 mm	1
11	423028	Plastik Kapak Büyük / Plastic Cap-Big		1
12	423029	Plastik Kapak Küçük / Plastic Cap-Small		1

Tip / Application

LRG 528, 532, 562

424168

Kaliper Tamir Takimi Komple (Ön Sağ) / Caliper Repair Kit Full (Front Right)

D3 series

Orjinal No:

Cross No :



S.No.	Ekersan No.	Ürün Tanıtımı / Description	Ölçü/Dimension	Miktar/Qty.
1	424173	Frezeli Mil (Sağ-Ön) / Shaft Gear Spline-Short (Front-Right)	26 teeth	1
2	422027	Ayar Dişlisi Büyük Sağ / Caliper Adjusting Gear (Big Right)		1
3	422029	Ayar Dişlisi Küçük / Caliper Adjusting Gear Small		1
4	424177	Kaliper Tane Bilya Takımı / Caliper Ball Bearing-Set	Ø 12 mm	1
5	422032	Kaliper Masura Bilya / Caliper Roller Bearing		1
6	423027	Toz Lastiği / Dust Cover		1
7	428019	Kaliper Dalgıllı Raynol / Caliper Wavy Shim		1
8	422031	Çırcı Ayar Çıvatası / Caliper Adjuster Bolt	M10x1,5x50 mm	1
9	423030	Çivata Lastiği / Screw Rubber		1
10	426025	Metal Bar / Bushing	Ø 50x55x20 mm	1
11	423028	Plastik Kapak Büyük / Plastic Cap-Big		1
12	423029	Plastik Kapak Küçük / Plastic Cap-Small		1

Tip / Application

LRG 529, 533, 563

424169

Kaliper Lastik & Perno Takimi / Caliper Boot & Pin Repair Kit

D3 series

Orjinal No : 826802808 / 826802809

Cross No : 5H8118C.01213



S.No.	Ekersan No.	Ürün Tanımı / Description	Ölçü/Dimension	Miktar/Qty.
1	424024	Kaliper Perno / Caliper Bolt	Ø 32x117 mm	1
2	424025	Kaliper Perno /	Ø 32x74 mm	1
3	425008	Kaliper Vidası / Caliper Screw	M18x1,5x117 mm	1
4	425005	Kaliper Vidası / Caliper Screw	M18x1,5x92 mm	1
5	423032	Tez Lastiği / Dust Cover		2
6	426027	Metal Burg / Metal Bushing	Ø 32x36x43 mm	2
7	426028	Metal Burg / Metal Bushing	Ø 32-33x36x30 mm	1
8	429013	Perno Kapağı / Bolt Plug	Ø 37x12 mm	2
9	429014	Tez Sacı / Dust Cover	Ø 32x61x28 mm	2

Tip / Application

LRG 524, 525, 526, 529, 532, 533, 562, 563, 622, 623

424170

Kaliper Lastik & Perno Takimi / Caliper Boot & Pin Repair Kit

D3 series

Orjinal No : 501322294

Cross No : 5H881



S.No.	Ekersan No.	Ürün Tanımı / Description	Ölçü/Dimension	Miktar/Qty.
1	424024	Kaliper Perno / Caliper Bolt	Ø 32x117 mm	1
2	424025	Kaliper Perno /	Ø 32x74 mm	1
3	425008	Kaliper Vidası / Caliper Screw	M18x1,5x117 mm	1
4	425005	Kaliper Vidası / Caliper Screw	M18x1,5x92 mm	1
5	423032	Tez Lastiği / Dust Cover		2
6	429013	Perno Kapağı / Bolt Plug	Ø 37x12 mm	2
7	429014	Tez Sacı / Dust Cover	Ø 32x61x28 mm	2

Tip / Application

LRG 526, 527

424171

Frezeli Mil Kapak Takimi / Caliper Cap & Bolts Set

D3 series

Orjinal No : 826802807 / 501303176

Cross No : 5J1212



S.No.	Ekersan No.	Ürün Tanımı / Description	Ölçü/Dimension	Miktar/Qty.
1	423027	Tez Lastiği / Dust Cover		1
2	423028	Plastik Kapak Büyük / Plastic Cap-Big		1
3	425021	Kaliper Vidası / Caliper Screw	M8x48 mm	4
4	425022	Kaliper Vidası / Screw	M1x1,25x20 mm	2

Tip / Application

LRG 524, 525, 526, 527, 528, 529, 532, 533, 622, 623

MERITOR**424172**

D3 series



Balata Tutucu / Caliper Brake Lining Plate

Original No:

Cross No :

S.No.	Ekersan No.	Ürün Tanıtımı / Description	Ölçü/Dimension	Miktar/Qty.
1	424172	Balata Tutucu / Caliper Brake Lining Plate		1

Tip / Application

LRG 524, 525, 526, 527, 528, 529, 532, 533, 632, 633

MERITOR**424173**

D3 series



Frezeli Mil (Sag-Ön) / Shaft Gear Spline-Short (Front-Right)

Original No:

Cross No :

S.No.	Ekersan No.	Ürün Tanıtımı / Description	Ölçü/Dimension	Miktar/Qty.
1	422025	Frezeli Mil (Sag-Ön) / Shaft Spline (Front-RI)	26 teeth	1
2	422025/1	Frezeli Mil Yatagi Sag /		1

Tip / Application

LRG 529, 533, 563

MERITOR**424174**

D3 series



Frezeli Mil (Sol-Ön) / Shaft Gear Spline-Short (Front-Left)

Original No:

Cross No :

S.No.	Ekersan No.	Ürün Tanıtımı / Description	Ölçü/Dimension	Miktar/Qty.
1	422024	Frezeli Mil (Sol-Ön) / Shaft Spline (Front-L)	26 teeth	1
2	422025/2	Frezeli Mil Yatagi Sol /		1

Tip / Application

LRG 528, 532, 562

MERITOR**424175**

Frezeli Mil (Sag-Arka) / Shaft Gear Spline-Long (Rear-Right)

D3 series

Orjinal No:

Cross No :

S.No.	Ekersan No.	Ürün Tanıtımı / Description	Ölçü/Dimension	Miktar/Qty.
1	422023	Frezeli Mil (Sag-Arka) / Shaft Spline (Rear-R)	26 dişli	1
2	422026/1	Frezeli Mil Yatagı/Sag /		1



Tip / Application

LRG 623

MERITOR**424176**

Frezeli Mil (Sol-Arka) / Shaft Gear Spline-Long (Rear-Left)

D3 series

Orjinal No:

Cross No :

S.No.	Ekersan No.	Ürün Tanıtımı / Description	Ölçü/Dimension	Miktar/Qty.
1	422022	Frezeli Mil (Sol-Arka) / Shaft Spline (Rear-L)	26 dişli	1
2	422026/2	Frezeli Mil Yatagı/Sol/		1



Tip / Application

LRG 622

MERITOR**424177**

Kaliper Tane Bilya Takımı / Caliper Ball Bearing-Set

D3 series

Orjinal No:

Cross No :

S.No.	Ekersan No.	Ürün Tanıtımı / Description	Ölçü/Dimension	Miktar/Qty.
1	423031	Bilya Kafesi / Bearing-Housing		1
2	422030	Tane Bilya /	Ø 12 mm	22



Tip / Application

LRG 524, 525, 526, 527, 528, 529, 532, 533, 622, 623

MERITOR**424178****Kaliper Yay Seti (Sag) / Caliper Spring Kit (Right)****D3 series****Orjinal No:****Cross No :**

S.No.	Ekersan No.	Ürün Tanıtımı / Description	Ölçü/Dimension	Miktar/Qty.
1	427013	Büyük Yay (Sag) / Spring Big (R)		1
2	427015	Küçük Yay Sag / Spring-Small (R)		1

Tip / Application

LRG 525, 527, 529, 533, 563, 623

MERITOR**424179****Kaliper Yay Seti (Sol) / Caliper Spring Kit (Left)****D3 series****Orjinal No:****Cross No :**

S.No.	Ekersan No.	Ürün Tanıtımı / Description	Ölçü/Dimension	Miktar/Qty.
1	427012	Büyük Yay (Sol) / Spring Big (L)		1
2	427014	Küçük Yay Sol / Spring-Small (L)		1

Tip / Application

LRG 524, 526, 528, 532, 562, 622

MERITOR**424185****Ayar Dislisi Kilit Takimi (Sag) / Clutch System (Right)****D3 series****Orjinal No:****Cross No :**

S.No.	Ekersan No.	Ürün Tanıtımı / Description	Ölçü/Dimension	Miktar/Qty.
1	427013	Büyük Yay (Sag) / Spring Big (R)		1
2	428026	Kubeksiz Pli /		4
3	428027	Kubekli Pli / Washer		3
4	427002	Yay Yatağı / Spring Housing		1

Tip / Application

LRG 525, 527, 529, 533, 563, 623

MERITOR

424186

Ayar Dislisi Kilit Takimi (Sol) / Clutch System (Left)

D3 series

Orjinal No:

Cross No :



S.No.	Ekarsan No.	Ürün Tanıtımı / Description	Ölçü/Dimension	Miktar/Qty.
1	427002	Büyük Yay (Sol) / Spring Big (L)		1
2	428026	Küçük Pul /		4
3	428027	Küçük Pul / Washer		3
4	427002	Yay Yatağı / Spring Housing		1

Tip / Application

LRG 524, 526, 528, 532, 562, 622

MERITOR

424187

Küçük Debriyaj Sistemi Takimi (Sağ) / Small Clutch System Kit (Right)

D3 series

Orjinal No:

Cross No :



S.No.	Ekarsan No.	Ürün Tanıtımı / Description	Ölçü/Dimension	Miktar/Qty.
1	422029	Ayar Disisi Küçük / Caliper Adjusting Gear Small		1
2	423030	Dişli Lastiği / Screw Rubber		1
3	428034	Raynel / Shim		1
4	427005	Küçük Yay Sağ / Spring-Small (R)		1
5	422031	Çirç Ayar Dişlisi / Caliper Adjuster Bolt	M18x1,5x90 mm	1

Tip / Application

LRG 525, 527, 529, 533, 563, 623

MERITOR

424188

Küçük Debriyaj Sistemi Takimi (Sol) / Small Clutch System Kit (Left)

D3 series

Orjinal No:

Cross No :



S.No.	Ekarsan No.	Ürün Tanıtımı / Description	Ölçü/Dimension	Miktar/Qty.
1	422029	Ayar Disisi Küçük / Caliper Adjusting Gear Small		1
2	423030	Dişli Lastiği / Screw Rubber		1
3	428034	Raynel / Shim		1
4	427004	Küçük Yay Sol / Spring-Small (L)		1
5	422031	Çirç Ayar Dişlisi / Caliper Adjuster Bolt	M18x1,5x90 mm	1

Tip / Application

LRG 524, 526, 528, 532, 562, 622

MERITOR

424211

Frezeli Mil (Sag-Ön) / Shaft Gear Spline-Short (Front-Right)

D3 series

Orjinal No:

Cross No :



S.No.	Ekersan No.	Ürün Tanıtımı / Description	Ölçü/Dimension	Miktar/Qty.
1	422038	Frezeli Mil (Sag-Ön) / Shaft Spline (Front-R)	48 teeth	1
2	422026/1	Frezeli Mil Yatagi Sag /		1

Tip / Application

LRG 525, 527

MERITOR

424212

Frezeli Mil (Sol-Ön) / Shaft Gear Spline-Short (Front-Left)

D3 series

Orjinal No:

Cross No :



S.No.	Ekersan No.	Ürün Tanıtımı / Description	Ölçü/Dimension	Miktar/Qty.
1	422037	Frezeli Mil (Sol-Ön) / Shaft Spline (Front-L)	48 teeth	1
2	422026/2	Frezeli Mil Yatagi Sol /		1

Tip / Application

LRG 524, 526

MERITOR

424214

Kaliper Lastik & Perno Takimi / Caliper Boot & Pin Repair Kit

D3 series

Orjinal No:

Cross No : 91213



S.No.	Ekersan No.	Ürün Tanıtımı / Description	Ölçü/Dimension	Miktar/Qty.
1	424024	Kaliper Pernosu / Caliper Bolt	Ø 32x117 mm	1
2	424025	Kaliper Pernosu /	Ø 32x74 mm	1
3	425018	Kaliper Vidası / Caliper Screw	M18x1,5x117 mm	1
4	425015	Kaliper Vidası / Caliper Screw	M18x1,5x92 mm	1
5	423032	Toz Lastığı / Dust Cover		2
6	426027	Metal Burç / Metal Bushing	Ø 32x36x42 mm	2
7	429013	Perno Kapağı / Bolt Plug	Ø 37x12 mm	2
8	429014	Toz Sacı / Dust Cover	Ø 32x61x20 mm	2

Tip / Application

LRG 532, 533, 622, 623

MERITOR

424215

Kaliper Tamir Takimi Komple (Ön Sağ) / Caliper Repair Kit Full (Front Right)

D3 series

Original No:

Cross No :



Tip / Application

LRG 525, 527

S.No.	Ekersan No.	Ürün Tanıtımı / Description	Ölçü/Dimension	Miktar/Qty.
1	424211	Frezeli Mil (Sağ-Ön) / Shaft Gear Spline-Short (Front-Right)	48 Teeth	1
2	422027	Ayar Dişlisi Büyük Sağ / Caliper Adjusting Gear (Big Right)		1
3	422029	Ayar Dişlisi Küçük / Caliper Adjusting Gear Small		1
4	424077	Kaliper Tane Bilya Takımı / Caliper Ball Bearing-Set	Ø 12 mm	1
5	422032	Kaliper Masura Bilya / Caliper Roller Bearing		1
6	423027	Toz Lastiği / Dust Cover		1
7	428009	Kaliper Dalgalı Raynel / Caliper Wavy Shim		1
8	422031	Çırcı Ayar Civatası / Caliper Adjuster Bolt	M16x1,5x50 mm	1
9	423030	Civata Lastiği / Screw Rubber		1
10	426025	Metal Dunc / Bushing	Ø 58x55x18 mm	1
11	423028	Plastik Kapak Büyük / Plastic Cap-Big		1
12	423029	Plastik Kapak Küçük / Plastic Cap-Small		1

MERITOR

424216

Kaliper Tamir Takimi Komple (Ön Sol) / Caliper Repair Kit Full (Front Left)

D3 series

Original No:

Cross No :



Tip / Application

LRG 524, 526

S.No.	Ekersan No.	Ürün Tanıtımı / Description	Ölçü/Dimension	Miktar/Qty.
1	424212	Frezeli Mil (Sol-Ön) / Shaft Gear Spline-Short (Front-Left)	48 Teeth	1
2	422028	Ayar Dişlisi Büyük Sol / Caliper Adjusting Gear (Big Left)		1
3	422029	Ayar Dişlisi Küçük / Caliper Adjusting Gear Small		1
4	424077	Kaliper Tane Bilya Takımı / Caliper Ball Bearing-Set	Ø 12 mm	1
5	422032	Kaliper Masura Bilya / Caliper Roller Bearing		1
6	423027	Toz Lastiği / Dust Cover		1
7	428009	Kaliper Dalgalı Raynel / Caliper Wavy Shim		1
8	422031	Çırcı Ayar Civatası / Caliper Adjuster Bolt	M16x1,5x50 mm	1
9	423030	Civata Lastiği / Screw Rubber		1
10	426025	Metal Dunc / Bushing	Ø 58x55x18 mm	1
11	423028	Plastik Kapak Büyük / Plastic Cap-Big		1
12	423029	Plastik Kapak Küçük / Plastic Cap-Small		1

MERITOR

424217

Kaliper Çırcını / Caliper Shaft Lever

D3 series

Original No:

Cross No :



Tip / Application

S.No.	Ekersan No.	Ürün Tanıtımı / Description	Ölçü/Dimension	Miktar/Qty.
1	424217	Kaliper Çırcını / Caliper Shaft Lever		1

MERITOR**424218****Kaliper Keçe Tamir Takımı / Caliper Seal Set****D3 series****Orjinal No:****Cross No :**

S.No.	Ekersan No.	Ürün Tanıtımı / Description	Ölçü/Dimension	Miktar/Qty.
1	428078	Kaliper Keçesi / Caliper Seal		10

**Tip / Application**

03

MERITOR**424219****Kaliper Sekman Seti / Caliper Circlip Set****D3 series****Orjinal No:****Cross No :**

S.No.	Ekersan No.	Ürün Tanıtımı / Description	Ölçü/Dimension	Miktar/Qty.
1	428079	Kaliper Sekmanı / Caliper Circlip		10

**Tip / Application**

03

MERITOR**424220****Kaliper Sekman & Keçe Tamir Seti / Caliper Circlip & Seal Set****D3 series****Orjinal No:****Cross No :**

S.No.	Ekersan No.	Ürün Tanıtımı / Description	Ölçü/Dimension	Miktar/Qty.
1	428078	Kaliper Keçesi / Caliper Seal		10
2	428079	Kaliper Sekmanı / Caliper Circlip		10

**Tip / Application**

03

MERITOR**424285**

Kaliper Lastik & Perno Takimi / Caliper Boot & Pin Repair Kit

D3 series

Orjinal No:

Cross No :



S.No.	Ekersan No.	Ürün Tanıtımı / Description	Ölçü/Dimension	Miktar/Qty.
1	424026	Kaliper Perno / Caliper Bolt	Ø 32x117 mm	1
2	424025	Kaliper Perno /	Ø 32x74 mm	1
3	425008	Kaliper Vidası / Caliper Screw	M18x1,5x117 mm	1
4	425035	Kaliper Vidası / Caliper Screw	M18x1,5x92 mm	1
5	423032	Toz Lastığı / Dust Cover		2
6	426027	Metal Burç / Metal Bushing	Ø 32x16x2 mm	2
7	426035	Metal Burç / Metal Bushing	Ø 32x16x2 mm	1
8	429034	Toz Sacı / Dust Cover	Ø 32x16x28 mm	2
9	429003	Perno Kapagı / Bolt Plug	Ø 37x12 mm	2

Tip / Application

LRG 524, 525, 528, 529, 532, 533, 562, 563, 622, 623

MERITOR**428019**

Kaliper Dalgali Raynel / Caliper Wavy Shim

D3 series

Orjinal No:

Cross No :



S.No.	Ekersan No.	Ürün Tanıtımı / Description	Ölçü/Dimension	Miktar/Qty.
1	428019	Kaliper Dalgali Raynel / Caliper Wavy Shim		1

Tip / Application

LRG 524, 525, 526, 527, 528, 529, 532, 533, 622, 623

MERITOR**423026**

Plastik Tapa / Plastic Plug

DUCO series

Original No:

Cross No : 6832655P K18



S.No.	Ekersan No.	Ürün Tanıtım / Description	Ölçü/Dimension	Miktar/Qty.
1	423026	Plastik Tapa / Plastic Plug		1

Tip / Application

ALL DUCO, ELSA2, 195, 225 SERIES

MERITOR**423026-1**

Plastik Tapa / Plastic Plug

DUCO series

Original No:

Cross No : 6832655



S.No.	Ekersan No.	Ürün Tanıtım / Description	Ölçü/Dimension	Miktar/Qty.
1	423026-1	Plastik Tapa / Plastic Plug		1

Tip / Application

ALL DUCO SERIES

MERITOR**424113**

Kaliper Masura Bilya Takımı / Caliper Roller Bearing Set

DUCO series

Original No: 3002202

Cross No :

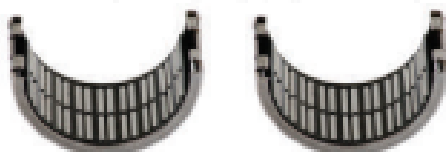

S.No.	Ekersan No.	Ürün Tanıtım / Description	Ölçü/Dimension	Miktar/Qty.
1	423602	Kaliper Masura Bilya / Caliper Roller Bearing		2

Tip / Application

ALL DUCO AND ELSA SERIES

VOLVO

424114

Kaliper Masura Bilya Takımı / Caliper Roller Bearing Set

DUCO series

Orjinal No : 3082229

Cross No : 5H112

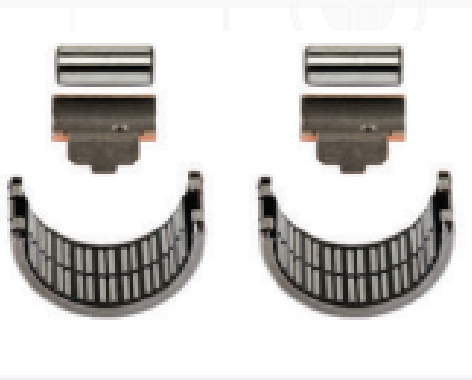

S.No.	Ekersan No.	Ürün Tanıtımı / Description	Ölçü/Dimension	Miktar/Qty.
1	426023	Bilya Yatağı Burcu /		2
2	426024	Bilya / Ball Bearing	Ø 16x38 mm	2
3	423602	Kaliper Masura Bilya / Caliper Roller Bearing		2

Tip / Application

ALL DUCO AND ELSA SERIES

424126

Kaliper Ayar Mekanizması (Ön) / Caliper Adjusting Mechanism (Front)

DUCO series

Orjinal No :

Cross No : MC 611135H110



S.No.	Ekersan No.	Ürün Tanıtımı / Description	Ölçü/Dimension	Miktar/Qty.
1	422015	Ayar Mekanizması Sol / Adjusting Mechanism (R-L)		1
2	428014	Küçük Keçe / Seal Small		1
3	428015	Büyük Keçe / Seal Big		1

Tip / Application

LRG 598, 599

424127

Kaliper Ayar Mekanizması (Arka Sağ) / Caliper Adjusting Mechanism (Rear Right)

DUCO series

Orjinal No :

Cross No : MC 611125H103



S.No.	Ekersan No.	Ürün Tanıtımı / Description	Ölçü/Dimension	Miktar/Qty.
1	422014	Ayar Mekanizması Sağ / Adjusting Mechanism (R)		1
2	428014	Küçük Keçe / Seal Small		1

Tip / Application

LRU 557, 561, 579, 598, 649, 651

424128

DUCO series

Kaliper Ayar Mekanizması (Arka Sol) / Caliper Adjusting Mechanism (Rear Left)

Orjinal No:

Cross No : MC 811115J4182

S.No.	Ekersan No.	Ürün Tanıtımı / Description	Ölçü/Dimension	Miktar/Qty.
1	422015	Ayar Mekanizması Sol / Adjusting Mechanism (R-L)		1
2	428014	Küçük Keçe / Seal Small		1



Tip / Application

LRG 536, 560, 578, 597, 648, 650

424129

DUCO series

Kaliper Kapak Conta Takimi / Cover Plate Gasket Kit

Orjinal No: 308628

Cross No : MC 81041

S.No.	Ekersan No.	Ürün Tanıtımı / Description	Ölçü/Dimension	Miktar/Qty.
1	421002	Conta / Gasket		1
2	428014	Küçük Keçe / Seal Small		1
3	428015	Büyük Keçe / Seal Big		1
4	429026	Plastik Tapa / Plastic Plug		1



Tip / Application

LRG 560, 561, 648, 649, 650, 651

424130

DUCO series

Kaliper Kapak Conta Takimi / Cover Plate Gasket Kit

Orjinal No: 308238

Cross No : 54185

S.No.	Ekersan No.	Ürün Tanıtımı / Description	Ölçü/Dimension	Miktar/Qty.
1	421003	Conta / Gasket		1
2	428014	Küçük Keçe / Seal Small		1
3	428015	Büyük Keçe / Seal Big		1
4	429026	Plastik Tapa / Plastic Plug		1



Tip / Application

LRG 536, 537, 578, 579, 596, 597, 652, 653

424131

Kaliper Kapak Conta Takimi / Cover Plate Gasket Kit

DUCO series

Orjinal No : 3092270

Cross No : 5H189



S.No.	Ekersan No.	Ürün Tanıtımı / Description	Ölçü/Dimension	Miktar/Qty.
1	421004	Conta / Gasket		1
2	428034	Küçük Keçe / Seal Small		1
3	428035	Büyük Keçe / Seal Big		1
4	423026-1	Plastik Tapa / Plastic Plug		1

Tip / Application

LRG 598, 599

424132

Kaliper Toz Lastigi Tamir Takimi / Caliper Tappet Heat

DUCO series

Orjinal No : 3092284

Cross No : MC K1238



S.No.	Ekersan No.	Ürün Tanıtımı / Description	Ölçü/Dimension	Miktar/Qty.
1	423025	Toz Lastigi / Dust Cover		2
2	422035	Kaliper Tapasi / Caliper Plug		2
3	428038	Sekman / Cirdip		2

Tip / Application

424133

Kaliper Ayar Mekanizma Takimi (Sag) / Caliper Adjusting Mechanism Kit (Right)

DUCO series

Orjinal No : 3092263

Cross No : MC K1237MC K1239



S.No.	Ekersan No.	Ürün Tanıtımı / Description	Ölçü/Dimension	Miktar/Qty.
1	422006	Ayar Mekanizmasi Sag / Adjusting Mechanism (R)		2
2	423025	Toz Lastigi / Dust Cover		2
3	426038	Sekman / Cirdip	Ø 37x47x12 mm	2
4	422035	Kaliper Tapasi / Caliper Plug		2
5	426039	Plastik Barç / Plastic Bushing	Ø 45x48x11 mm	2

Tip / Application

LRG 537, 552, 553, 561, 579, 597, 598, 599, 649, 651, 653

424134

Kaliper Ayar Mekanizma Takimi (Sol) / Caliper Adjusting Mechanism Kit (Left)

DUCO series

Original No: 3062362

Cross No : MC 61236



S.No.	Ekersan No.	Ürün Tanıtımı / Description	Ölçü/Dimension	Miktar/Qty.
1	422017	Ayar Mekanizması Sol / Adjusting Mechanism (L)		2
2	423025	Toz Lastığı / Dust Cover		2
3	428018	Sekman / Circlip		2
4	422035	Kaliper Tapası / Caliper Plug		2
5	426019	Plastik Burç / Plastic Bushing	Ø 45x49x31 mm	2

Tip / Application

LRG 536, 560, 578, 596, 648, 650, 652

424135

Kaliper Ayar Mekanizma Takimi (Sağ) / Caliper Adjusting Tappet Kit (Right)

DUCO series

Original No:

Cross No :



S.No.	Ekersan No.	Ürün Tanıtımı / Description	Ölçü/Dimension	Miktar/Qty.
1	422016	Ayar Mekanizması Sağ / Adjusting Mechanism (R)		1
2	423025	Toz Lastığı / Dust Cover		1
3	428018	Sekman / Circlip		1
4	422035	Kaliper Tapası / Caliper Plug		1
5	426019	Plastik Burç / Plastic Bushing	Ø 45x49x31 mm	1

Tip / Application

DUCO SERIES

424136

Kaliper Ayar Mekanizma Takimi (Sol) / Caliper Adjusting Tappet Kit (Left)

DUCO series

Original No:

Cross No :



S.No.	Ekersan No.	Ürün Tanıtımı / Description	Ölçü/Dimension	Miktar/Qty.
1	422017	Ayar Mekanizması Sol / Adjusting Mechanism (L)		1
2	423025	Toz Lastığı / Dust Cover		1
3	428018	Sekman / Circlip		1
4	422035	Kaliper Tapası / Caliper Plug		1
5	426019	Plastik Burç / Plastic Bushing	Ø 45x49x31 mm	1

Tip / Application

DUCO SERIES

424137

Perno Tamir Takimi / Caliper Pin Repair Kit

DUCO series

Orjinal No : 3092250 / 3099621 / 85102024

Cross No : MC K1118MC K1134J4894



S.No.	Ekersan No.	Ürün Tanıtımı / Description	Ölçü/Dimension	Miktar/Qty.
1	429022	Kaliper Perno / Caliper Bolt	Ø 35x102 mm	1
2	429023	Kaliper Perno /	Ø 35x68 mm	1
3	425006	Kaliper Vidası / Caliper Screw	M20x2x125 mm	1
4	425017	Kaliper Vidası / Caliper Screw	M20x2x80 mm	1
5	429022	Tez Lastiği / Dust Cover		2
6	426022	Metal Burç / Bushing	Ø 35-36x39x30 mm	2
7	426020	Plastik Burç / Plastic Bushing	Ø 48x35x17 mm	1
8	426021	Kaliper Yüzüğü / Ring	Ø 37x48x11 mm	2
9	429003	Perno Kapağı / Bolt Plug	Ø 37x12 mm	2

Tip / Application

424138

Perno Tamir Takimi / Caliper Pin Repair Kit

DUCO series

Orjinal No : 3092250 / 3099704 / 85102022

Cross No : MC K1118MC K1135J4187



S.No.	Ekersan No.	Ürün Tanıtımı / Description	Ölçü/Dimension	Miktar/Qty.
1	429022	Kaliper Perno / Caliper Bolt	Ø 35x102 mm	2
2	425006	Kaliper Vidası / Caliper Screw	M20x2x125 mm	2
3	429022	Tez Lastiği / Dust Cover		2
4	426022	Metal Burç / Bushing	Ø 35-36x39x30 mm	2
5	426020	Plastik Burç / Plastic Bushing	Ø 48x35x17 mm	1
6	429002	Perno Tapası / Bolt Plug	Ø 48x18 mm	2
7	426021	Kaliper Yüzüğü / Ring	Ø 37x48x11 mm	2
8	429003	Perno Kapağı / Bolt Plug	Ø 37x12 mm	2

Tip / Application

LRG 598, 599

424139

Kaliper Masura Bilya Yatak Seti / Caliper Lever Set

DUCO series

Orjinal No :

Cross No :



S.No.	Ekersan No.	Ürün Tanıtımı / Description	Ölçü/Dimension	Miktar/Qty.
1	423604	Masura Bilya Yatağı / Caliper Lever		1
2	426029	Bilya Yatak Burcu /		2
3	426024	Bilya / Ball Bearing	Ø 16x18 mm	2

Tip / Application

pervo çarçırı

424139-1

Kaliper Masura Bilya Yatak Seti / Caliper Lever Set

DUCO series

Orjinal No:

Cross No : MC 84108



S.No.	Ekersan No.	Ürün Tanıtımı / Description	Ölçü/Dimension	Miktar/Qty.
1	423004	Masura Bilya Yatağı / Caliper Lever		1
2	426029	Bilya Yatak Burcu /		2
3	426024	Bilya / Ball Bearing	Ø 16x38 mm	2
4	423602	Kaliper Masura Bilya / Caliper Roller Bearing		2
5	428015	Büyük Keçe / Seal Big		1

Tip / Application

DUCO SERIES

424140

Kaliper Perno Tamir Takimi / Caliper Pin Repair Kit

DUCO series

Orjinal No:

Cross No :



S.No.	Ekersan No.	Ürün Tanıtımı / Description	Ölçü/Dimension	Miktar/Qty.
1	424022	Kaliper Pernosu / Caliper Bolt	Ø 35x182 mm	2
2	423022	Toz Lastığı / Dust Cover		2
3	423025	Toz Lastığı / Dust Cover		2
4	426022	Metal Burç / Bushing	Ø 35-36x39x38 mm	2
5	426020	Plastik Burç / Plastic Bushing	Ø 40x35x77 mm	1

Tip / Application

DUCO SERIES

424141

Kaliper Perno Tamir Takimi / Caliper Pin Repair Kit

DUCO series

Orjinal No:

Cross No : MC E1065ME E1064



S.No.	Ekersan No.	Ürün Tanıtımı / Description	Ölçü/Dimension	Miktar/Qty.
1	424022	Kaliper Pernosu / Caliper Bolt	Ø 35x182 mm	1
2	423022	Toz Lastığı / Dust Cover		2
3	429012	Perno Tapası / Bolt Plug	Ø 40x18 mm	2

Tip / Application

424142

Kaliper Perno Tamir Takimi / Caliper Pin Repair Kit

DUCO series

Orjinal No: 3095628 / 83307118

Cross No : WC 61399



S.No.	Ekersan No.	Ürün Tanımı / Description	Ölçü/Dimension	Miktar/Qty.
1	424022	Kaliper Perno / Caliper Bolt	Ø 35x102 mm	1
2	425006	Kaliper Vidası / Caliper Screw	M20x2x125 mm	2
3	425007	Kaliper Vidası / Caliper Screw	M20x2x80 mm	1
4	423022	Toz Lastığı / Dust Cover		2
5	423012	Perno Tapası / Bolt Plug	Ø 48x18 mm	2

Tip / Application

424145

Kaliper Masura Bilya Yatagi (Sol) / Caliper Lever (Left)

DUCO series

Orjinal No:

Cross No :

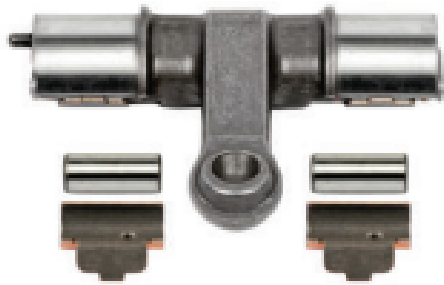

S.No.	Ekersan No.	Ürün Tanımı / Description	Ölçü/Dimension	Miktar/Qty.
1	423606	Masura Bilya Yatagi Sol / Caliper Lever (L)		1
2	426023	Bilya Yatak Burcu /		2
3	426024	Bilya / Ball Bearing	Ø 16x8 mm	2

Tip / Application

DUCO SERIES

424145-1

Kaliper Masura Bilya Yatak Seti (Sol) / Caliper Lever Set (Left)

DUCO series

Orjinal No:

Cross No : 54497



S.No.	Ekersan No.	Ürün Tanımı / Description	Ölçü/Dimension	Miktar/Qty.
1	423606	Masura Bilya Yatagi Sol / Caliper Lever (L)		1
2	426023	Bilya Yatak Burcu /		2
3	426024	Bilya / Ball Bearing	Ø 16x8 mm	2
4	423602	Kaliper Masura Bilya / Caliper Roller Bearing		2
5	428015	Büyük Keçe / Seal Ring		1

Tip / Application

LR6 537, 553, 561, 579, 597

424146

Kaliper Masura Bilya Yatagi (Sag) / Caliper Lever (Right)

DUCO series

Orjinal No:

Cross No :

S.No.	Ekersan No.	Ürün Tanımı / Description	Ölçü/Dimension	Miktar/Qty.
1	423606	Masura Bilya Yatagi Sag / Caliper Lever (R)		1
2	426023	Bilya Yatak Burcu /		2
3	426024	Bilya / Ball Bearing	Ø 16x38 mm	2

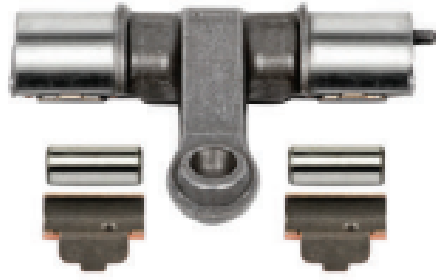

Tip / Application

DUCO SERIES

424146-1

Kaliper Masura Bilya Yatak Seti (Sag) / Caliper Lever Set (Right)

DUCO series

Orjinal No:

Cross No : 94086

S.No.	Ekersan No.	Ürün Tanımı / Description	Ölçü/Dimension	Miktar/Qty.
1	423606	Masura Bilya Yatagi Sag / Caliper Lever (R)		1
2	426023	Bilya Yatak Burcu /		2
3	426024	Bilya / Ball Bearing	Ø 16x38 mm	2
4	423602	Kaliper Masura Bilya / Caliper Roller Bearing		2
5	428015	Büyük Keçe / Seal Ring		1

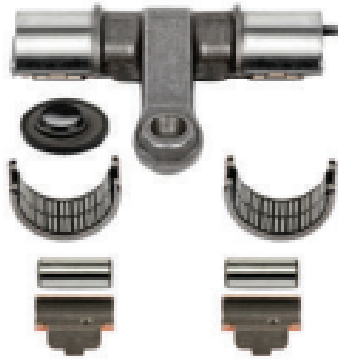

Tip / Application

LRG 536, 552, 560, 578, 596

424147

Kaliper Merkez Disli Takimi / Caliper Intermediate Gear Kit

DUCO series

Orjinal No: 309628 / 309221

Cross No : M1 61067

S.No.	Ekersan No.	Ürün Tanımı / Description	Ölçü/Dimension	Miktar/Qty.
1	422018	Kaliper Merkez Disli / Caliper Shaft Gear		1
2	427007	Yay Spring		1
3	427008	Yay Spring		1



Tip / Application

MERITOR**424148****Sabitleme Saci / Anti Rotation Plate****DUCO series****Orjinal No:****Cross No :** 68322900P R10

S.No.	Ekansan No.	Ürün Tanıtımı / Description	Ölçü/Dimension	Miktar/Qty.
1	424148	Sabitleme Saci / Anti Rotation Plate		1

Tip / Application

IRG 536, 537, 578, 579, 596, 597, 598, 599, 652, 653

MERITOR**424149****Kaliper Toz Lastiği Set / Caliper Dust Cover Set****DUCO series****Orjinal No:****Cross No :**

S.No.	Ekansan No.	Ürün Tanıtımı / Description	Ölçü/Dimension	Miktar/Qty.
1	423025	Toz Lastiği / Dust Cover		2

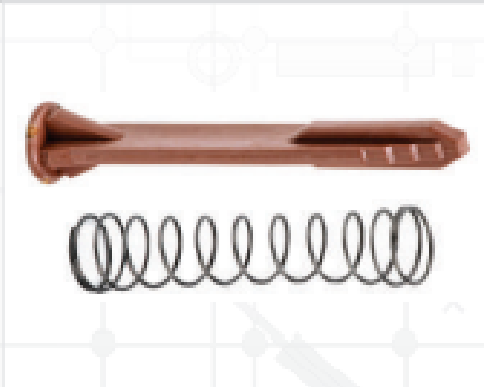
Tip / Application**MERITOR****424207****Seviye Gösterge Çubuğu / Caliper Indicator Bar****DUCO series****Orjinal No:****Cross No :** 5H111

S.No.	Ekansan No.	Ürün Tanıtımı / Description	Ölçü/Dimension	Miktar/Qty.
1	424207	Seviye Gösterge Çubuğu / Caliper Indicator Bar		1
2	427040	Yay / Spring		1

Tip / Application

MERITOR

424213

Kaliper Masura Bilya Takımı / Caliper Roller Bearing Set

DUCO series

Orjinal No:

Cross No : 94098

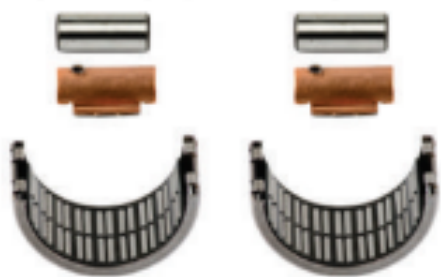

S.No.	Ekersan No.	Ürün Tanımı / Description	Ölçü/Dimension	Miktar/Qty.
1	426029	Bilya Yatakları /		2
2	426024	Bilya / Ball Bearing	Ø 16x38 mm	2
3	423502	Kaliper Masura Bilya / Caliper Roller Bearing		2

Tip / Application

ALL DUCO AND ELSA SERIES

MERITOR

424222

Kaliper Balata Tutucu / Caliper Pad Retainer

DUCO series

Orjinal No:

Cross No : MC 81264

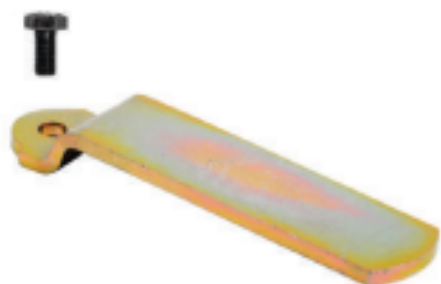

S.No.	Ekersan No.	Ürün Tanımı / Description	Ölçü/Dimension	Miktar/Qty.
1	425640	Pad Tutucu / Brake Pad Retainer		1
2	425057	Yılda Screw		1

Tip / Application

DUCO SERIES

MERITOR

424223

Ayar Dislisi Sag / Caliper Adjusting Gear (Right)

DUCO series

Orjinal No:

Cross No :



S.No.	Ekersan No.	Ürün Tanımı / Description	Ölçü/Dimension	Miktar/Qty.
1	424223	Ayar Dislisi Sag / Caliper Adjusting Gear (Right)		1

Tip / Application

DUCO SERIES

MERITOR

424224

Ayar Dİslisi Sol / Caliper Adjusting Gear (Left)

DUCO series

Orjinal No:

Cross No :



S.No.	Ekersan No.	Ürün Tanıtım / Description	Ölçü/Dimension	Miktar/Qty.
1	424224	Ayar Dİslisi Sol / Caliper Adjusting Gear (Left)		1

Tip / Application

DUCO SERIES

MERITOR

424266

Kaliper Tamir Takimi Komple (Ön - Sağ/Sol) / Caliper Repair Kit Full (Front - Right/Left)

DUCO series

Orjinal No:

Cross No :



S.No.	Ekersan No.	Ürün Tanıtım / Description	Ölçü/Dimension	Miktar/Qty.
1	424138	Perno Tamir Takımı / Caliper Pin Repair Kit		1
2	424133	Kaliper Ayar Mekanizma Takımı (Sağ) / Caliper Adjusting Mechanism Kit (Right)		1
3	424223	Ayar Dİslisi Sağ / Caliper Adjusting Gear (Right)		1
4	424126	Kaliper Ayar Mekanizması (Ön) / Caliper Adjusting Mechanism (Front)		1
5	424114	Kaliper Masura Bilya Takımı / Caliper Roller Bearing Set		1
6	424147	Kaliper Merkez Dİsl Takımı / Caliper Intermediate Gear Kit		1
7	424148	Sabitleme Sacı / Anti Rotation Plate		1
8	424226	Kaliper Rulman Takımı / Caliper Roller Bearing Kit		1
9	424131	Kaliper Kapak Conta Takımı / Cover Plate Gasket Kit		1

Tip / Application

MERITOR

424267

Kaliper Tamir Takimi Komple (Arka - Sağ) / Caliper Repair Kit Full (Rear - Right)

DUCO series

Orjinal No:

Cross No :



S.No.	Ekersan No.	Ürün Tanıtım / Description	Ölçü/Dimension	Miktar/Qty.
1	424137	Perno Tamir Takımı / Caliper Pin Repair Kit		1
2	424133	Kaliper Ayar Mekanizma Takımı (Sağ) / Caliper Adjusting Mechanism Kit (Right)		1
3	424223	Ayar Dİslisi Sağ / Caliper Adjusting Gear (Right)		1
4	424127	Kaliper Ayar Mekanizması (Arka Sağ) / Caliper Adjusting Mechanism (Rear Right)		1
5	424114	Kaliper Masura Bilya Takımı / Caliper Roller Bearing Set		1
6	424147	Kaliper Merkez Dİsl Takımı / Caliper Intermediate Gear Kit		1
7	424148	Sabitleme Sacı / Anti Rotation Plate		1
8	424207	Seriye Göstergesi Çubuğu / Caliper Indicator Bar		1
9	424129	Kaliper Kapak Conta Takımı / Cover Plate Gasket Kit		1

Tip / Application

MERITOR

424268

Kaliper Tamir Takimi Komple (Arka - Sol) / Caliper Repair Kit Full (Rear - Left)

DUCO series

Orjinal No:

Cross No :

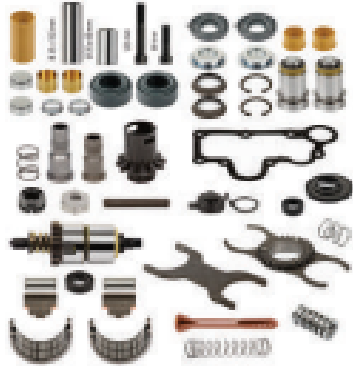

S.No.	Ekansan No.	Ürün Tanıtımı / Description	Ölçü/Dimension	Miktar/Qty.
1	424137	Perno Tamir Takımı / Caliper Pin Repair Kit		1
2	424134	Kaliper Ayar Mekanizması Takımı (Sol) / Caliper Adjusting Mechanism Kit (Left)		1
3	424224	Ayar Dişlisi Sol / Caliper Adjusting Gear (Left)		1
4	424128	Kaliper Ayar Mekanizması (Arka Sol) / Caliper Adjusting Mechanism (Rear Left)		1
5	424114	Kaliper Masura Bilya Takımı / Caliper Roller Bearing Set		5
6	424147	Kaliper Merkez Dişi Takımı / Caliper Intermediate Gear Kit		6
7	424148	Sabitleme Sacı / Anti Rotation Plate		1
8	424207	Sevki Gösterge Çubuğu / Caliper Indicator Bar		1
9	424129	Kaliper Kapak Conta Takımı / Cover Plate Gasket Kit		1

Tip / Application

MERITOR

424280

Kaliper Toz Lastiği Set / Caliper Dust Cover Set

DUCO series

Orjinal No:

Cross No :



S.No.	Ekansan No.	Ürün Tanıtımı / Description	Ölçü/Dimension	Miktar/Qty.
1	423022	Toz Lastiği / Dust Cover		1

Tip / Application

MERITOR

424180

Kaliper Soft Seti / Caliper Shaft Set

DX 195 series

Orjinal No:

Cross No :



S.No.	Ekarsan No.	Ürün Tanıtımı / Description	Ölçü/Dimension	Miktar/Qty.
1	422036	Krank / Crank		1
2	422036	Yalman /		2

Tip / Application

DX.195.51, DX.195.52

MERITOR

424181

Lastik & Perno Takimi / Caliper Boot & Pin Repair Kit

DX 195 series

Orjinal No:

Cross No : AK 81171



S.No.	Ekarsan No.	Ürün Tanıtımı / Description	Ölçü/Dimension	Miktar/Qty.
1	424032	Kaliper Peması / Caliper Bolt	Ø 32x97 / 37 mm	1
2	424033	Kaliper Peması /	Ø 32x97 / 62 mm	1
3	425004	Kaliper Vidası / Caliper Screw	M16x1,5x80 mm	1
4	425000	Kaliper Vidası / Caliper Screw	M16x1,5x55 mm	1
5	423039	Büyük Toz Lastiği / Dust Cover Big		2
6	423040	Küçük Toz Lastiği / Dust Cover Small		2
7	423041	Kapak Keçesi / Sealing Ring		2
8	429029	Perno Tapası / Bolt Plug	Ø 43x8 mm	2
9	421008	Corba / Gasket		1
10	425027	Kaliper Vidası / Caliper Screw	M16x1,5x20 mm	2
11	425028	Kaliper Vidası / Caliper Screw		2

Tip / Application

DX.195.51, DX.195.52

MERITOR

424184

Kaliper Dürbünü / Caliper Bridge Assembly

DX 195 series

Orjinal No:

Cross No :



S.No.	Ekarsan No.	Ürün Tanıtımı / Description	Ölçü/Dimension	Miktar/Qty.
1	424184	Kaliper Dürbünü / Caliper Bridge Assembly	162,50 mm	1

Tip / Application

DX.195.51, DX.195.52

MERITOR

424201

Kaliper Rulmanı / Caliper Bearing

DX 195 series

Orjinal No:

Cross No :



S.No.	Ekersan No.	Ürün Tanımı / Description	Ölçü/Dimension	Miktar/Qty.
1	424201	Kaliper Rulmanı / Caliper Bearing		1

Tip / Application

DX.195.51, DX.195.52

MERITOR

424202

Kaliper Lastik & Perno Takimi / Caliper Boot & Pin Repair Kit

DX 195 series

Orjinal No:

Cross No : MC 81192



S.No.	Ekersan No.	Ürün Tanımı / Description	Ölçü/Dimension	Miktar/Qty.
1	429004	Kaliper Vidası / Caliper Screw	M16x1,5x80 mm	1
2	429000	Kaliper Vidası / Caliper Screw	M16x1,5x55 mm	1
3	423039	Büyük Toz Lastiği / Dust Cover Big		2
4	423040	Küçük Toz Lastiği / Dust Cover Small		2
5	429019	Perno Tapesi / Bolt Plug	Ø-40x28 mm	2

Tip / Application

DX.195.51, DX.195.52

MERITOR

424225

Kaliper Shaft Seti / Caliper Shaft Set

DX 195 series

Orjinal No:

Cross No :



S.No.	Ekersan No.	Ürün Tanımı / Description	Ölçü/Dimension	Miktar/Qty.
1	423026	Krank / Crank		1
2	429017	Keçe Seal		1

Tip / Application

DX.195.51, DX.195.52

MERITOR**424226**

Kaliper Rulman Takimi / Caliper Roller Bearing Kit

DX 195 series

Orjinal No:

Cross No :



S.No.	Ekersan No.	Ürün Tanıtımı / Description	Ölçü/Dimension	Miktar/Qty.
1	424201	Kaliper Rulmanı / Caliper Bearing		1
2	422036	Rulman /		2

Tip / Application

DX.195.51, DX.195.52

MERITOR**424227**

Kaliper Piston Tamir Takimi (Sağ) / Caliper Piston Repair Kit (Right)

DX 195 series

Orjinal No:

Cross No :



S.No.	Ekersan No.	Ürün Tanıtımı / Description	Ölçü/Dimension	Miktar/Qty.
1	424042	Kaliper Pemasu Sağ / Caliper Pin (R)		2
2	422056	Kaliper Dişli / Caliper Gear		2

Tip / Application

DX.195.52

MERITOR**424228**

Kaliper Piston Tamir Takimi (Sol) / Caliper Piston Repair Kit (Left)

DX 195 series

Orjinal No:

Cross No :



S.No.	Ekersan No.	Ürün Tanıtımı / Description	Ölçü/Dimension	Miktar/Qty.
1	424043	Kaliper Pemasu Sol / Caliper Pin (L)		2
2	422056	Kaliper Dişli / Caliper Gear		2

Tip / Application

DX.195.51

424229

Kaliper Itici Pleyt Tamir Takimi (Sağ) / Caliper Push Plate Repair Kit (Right)

DX 195 series

Orjinal No:

Cross No :

S.No.	Ekersan No.	Ürün Tanıtımı / Description	Ölçü/Dimension	Miktar/Qty.
1	423055	Pleyt / Plate		1
2	425038	Kaliper Vidası Sağ / Caliper Bolt (R)		2
3	425037	Kaliper Vidası / Caliper Screw	M10x1,5x20 mm	2



Tip / Application

DX.195.52

424230

Kaliper Itici Pleyt Tamir Takimi (Sol) / Caliper Push Plate Repair Kit (Left)

DX 195 series

Orjinal No:

Cross No :

S.No.	Ekersan No.	Ürün Tanıtımı / Description	Ölçü/Dimension	Miktar/Qty.
1	423055	Pleyt / Plate		1
2	425039	Kaliper Vidası Sol / Caliper Bolt (L)		2
3	425037	Kaliper Vidası / Caliper Screw	M10x1,5x20 mm	2



Tip / Application

DX.195.51

424231

Kaliper Ayar Mekanizma Takimi (Sağ) / Caliper Adjusting Mechanism Kit (Right)

DX 195 series

Orjinal No:

Cross No : 09.5R

S.No.	Ekersan No.	Ürün Tanıtımı / Description	Ölçü/Dimension	Miktar/Qty.
1	422059	Ayar Mekanizması Sağ / Adjusting Mechanism (R)		1
2	422061	Pim / Pin		1
3	427020	Yay / Spring		1
4	428038	Yeşil Gece / Green Seal		2
5	428039	Sekman / Circlip		2
6	428040	Raynel / Wavy Washer		2



Tip / Application

DX.195.52

MERITOR**424232**

DX 195 series



Kaliper Ayar Mekanizma Takimi (Sol) / Caliper Adjusting Mechanism Kit (Left)

Orjinal No:

Cross No : 09151

S.No.	Ekersan No.	Ürün Tanıtımı / Description	Ölçü/Dimension	Miktar/Qty.
1	422060	Ayar Mekanizması Sol / Adjusting Mechanism (L)		1
2	428038	Yeşil Gece / Green Seal		2
3	428039	Sekman / Circlip		2
4	428040	Raynel / Wavy Washer		2
5	425031	Takliye Vidalı Pulu / Washer	Ø 15x13 mm	8

Tip / Application

DX.195.51

MERITOR**424233**

DX 195 series



Kaliper Ayar Tamir Takimi (Sag) / Caliper Adjusting Repair Kit (Right)

Orjinal No:

Cross No : MC K1293

S.No.	Ekersan No.	Ürün Tanıtımı / Description	Ölçü/Dimension	Miktar/Qty.
1	424184	Kaliper Dörbüğü / Caliper Bridge Assembly	162,50 mm	1
2	422055	Plav / Plate		1
3	424042	Kaliper Pimosa Sag / Caliper Pin (R)		2
4	425038	Kaliper Vidalı Sag / Caliper Bolt (R)		2
5	422056	Kaliper Dişli / Caliper Gear		2
6	422057	Dişli Merkez Dis / Mechanism Central Fork		1
7	422058	Kaliper Dişli Pinyon / Caliper Mechanism Pinion		1
8	425037	Kaliper Vidalı / Caliper Screw	M18x1,5x20 mm	2

Tip / Application

DX.195.52

MERITOR**424234**

DX 195 series



Kaliper Ayar Tamir Takimi (Sol) / Caliper Adjusting Repair Kit (Left)

Orjinal No:

Cross No : MC K1292

S.No.	Ekersan No.	Ürün Tanıtımı / Description	Ölçü/Dimension	Miktar/Qty.
1	424184	Kaliper Dörbüğü / Caliper Bridge Assembly	162,50 mm	1
2	422055	Plav / Plate		1
3	424043	Kaliper Pimosa Sol / Caliper Pin (L)		2
4	425039	Kaliper Vidalı Sol / Caliper Bolt (L)		2
5	422056	Kaliper Dişli / Caliper Gear		2
6	422057	Dişli Merkez Dis / Mechanism Central Fork		1
7	422058	Kaliper Dişli Pinyon / Caliper Mechanism Pinion		1
8	425037	Kaliper Vidalı / Caliper Screw	M18x1,5x20 mm	2

Tip / Application

DX.195.51

MERITOR

424235

Kaliper Ayar Mekanizma Seti (Sağ) / Caliper Adjusting Mechanism Set (Right)

DX 195 series

Orjinal No:

Cross No : MC 81291

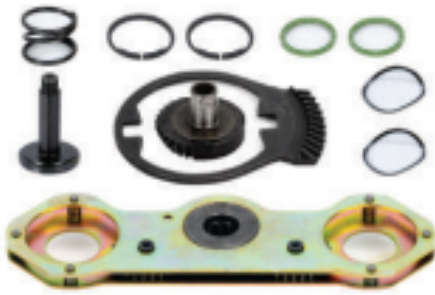

S.No.	Ekersan No.	Ürün Tanıtımı / Description	Ölçü/Dimension	Miktar/Qty.
1	422059	Ayar Mekanizması Sağ / Adjusting Mechanism (R)		1
2	428038	Yeşil Geçe / Green Seal		2
3	428039	Sekman / Circlip		2
4	428040	Raynal / Wavy Washer		2
5	422057	Dişli Merkezli Disk / Mechanism Central Fork		1
6	422058	Kaliper Dişli Pinyon / Caliper Mechanism Pinion		1

Tip / Application

DX.195.52

MERITOR

424236

Kaliper Ayar Mekanizma Seti (Sol) / Caliper Adjusting Mechanism Set (Left)

DX 195 series

Orjinal No:

Cross No : MC 81298

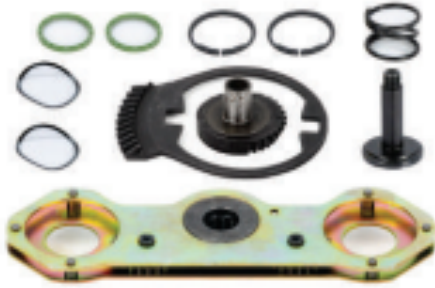

S.No.	Ekersan No.	Ürün Tanıtımı / Description	Ölçü/Dimension	Miktar/Qty.
1	422060	Ayar Mekanizması Sol / Adjusting Mechanism (L)		1
2	428038	Yeşil Geçe / Green Seal		2
3	428039	Sekman / Circlip		2
4	428040	Raynal / Wavy Washer		2
5	422057	Dişli Merkezli Disk / Mechanism Central Fork		1
6	422058	Kaliper Dişli Pinyon / Caliper Mechanism Pinion		1

Tip / Application

DX.195.51

MERITOR

424237

Kaliper Shaft Yatagi / Caliper Shaft Bearing

DX 195 series

Orjinal No:

Cross No :



S.No.	Ekersan No.	Ürün Tanıtımı / Description	Ölçü/Dimension	Miktar/Qty.
1	422063	Bilye Yatagi / Housing Bearing Unit		1
2	421008	Conta / Gasket		1
3	429030	Kaliper Vidasi / Caliper Screw	M8x1,25x20 mm	2

Tip / Application

DX 195.51, DX 195.52

MERITOR**424238**

Kaliper Saft Ayar Kolu / Caliper Shaft Setting Lever

DX 195 series

Orjinal No:

Cross No : MC 01180



S.No.	Ekersan No.	Ürün Tanıtımı / Description	Ölçü/Dimension	Miktar/Qty.
1	422073	Hanket Kolu / Shaft Lever	80 mm	1
2	425043	Kaliper Vidası /		1

Tip / Application

DX 195.51, DX 195.52

MERITOR**424239**

Balata Tutucu / Caliper Pad Retainer

DX 195 series

Orjinal No:

Cross No :



S.No.	Ekersan No.	Ürün Tanıtımı / Description	Ölçü/Dimension	Miktar/Qty.
1	424239	Balata Tutucu / Caliper Pad Retainer		1

Tip / Application

DX 195.51, DX 195.52

MERITOR**424240**

Kaliper Balata Tutucu Tamir Takımı / Caliper Pad Retainer Repair Kit

DX 195 series

Orjinal No:

Cross No :



S.No.	Ekersan No.	Ürün Tanıtımı / Description	Ölçü/Dimension	Miktar/Qty.
1	424239	Balata Tutucu / Caliper Pad Retainer		1
2	428080	Balata Tutucu Yaylı /		2
3	428082	Kopilya / Cotter Pin		1
4	425052	Tahliye Vidası / Screw		1
5	425031	Tahliye Vidası Pulu / Washer	Ø 18x11 mm	1

Tip / Application

DX 195.51, DX 195.52

MERITOR**424240-1****Kaliper Balata Tutucu Tamir Takimi / Caliper Pad Retainer Repair Kit**

DX 195 series

Orjinal No:

Cross No :



S.No.	Ekersan No.	Ürün Tanıtımı / Description	Ölçü/Dimension	Miktar/Qty.
1	424239	Balata Tutucu / Caliper Pad Retainer		2
2	428080	Balata Tutucu Yaylı /		4
3	428082	Kapıya / Cotter Pin		2
4	425052	Tahliye Vidası / Screw		2
5	435031	Tahliye Vidası Pulu / Washer	Ø 19x13 mm	2
6	428081	Pim / Pin		2

Tip / Application

DX 195.51, DX 195.52

MERITOR**424241****Kaliper Pul Tamir Takımı / Caliper Washer Repair Kit**

DX 195 series

Orjinal No:

Cross No :



S.No.	Ekersan No.	Ürün Tanıtımı / Description	Ölçü/Dimension	Miktar/Qty.
1	424241	Kaliper Pul Tamir Takımı / Caliper Washer Repair Kit		5

Tip / Application

DX 195.51, DX 195.52

MERITOR**424242****Kaliper Mil Toz Lastiği / Caliper Shaft Dust Cover**

DX 195 series

Orjinal No:

Cross No :



S.No.	Ekersan No.	Ürün Tanıtımı / Description	Ölçü/Dimension	Miktar/Qty.
1	423087	Toz Lastiği / Dust Cover		5

Tip / Application

DX 195.51, DX 195.52

MERITOR**424243****Kapak Keçe Takımı / Cover Plate Seal Set****DX 195 series****Orjinal No:****Cross No :****Tip / Application**

DX 195.51, DX 195.52

S.No.	Ekersan No.	Ürün Tanıtımı / Description	Ölçü/Dimension	Miktar/Qty.
1	420035	Kapak Keçesi / Cover Plate Seal		5

MERITOR**424264****Kaliper Tamir Takımı Komple (Sağ) / Caliper Repair Kit Full (Right)****DX 195 series****Orjinal No:****Cross No :****Tip / Application**

S.No.	Ekersan No.	Ürün Tanıtımı / Description	Ölçü/Dimension	Miktar/Qty.
1	424080	Lastik & Perno Takımı / Caliper Boot & Pin Repair Kit		1
2	424235	Kaliper Ayar Mekanizma Seti (Sağ) / Caliper Adjusting Mechanism Set (Right)		1
3	424227	Kaliper Piston Tamir Takımı (Sağ) / Caliper Piston Repair Kit (Right)		1
4	424229	Kaliper İtici Pleyt Tamir Takımı (Sağ) / Caliper Push Plate Repair Kit (Right)		1
5	424104	Kaliper Dişli Birliği / Caliper Bridge Assembly	162,50 mm	1
6	424225	Kaliper Şaft Seti / Caliper Shaft Set		1
7	424238	Kaliper Şaft Ayar Kolu / Caliper Shaft Setting Lever	80 mm	1
8	424226	Kaliper Rulman Takımı / Caliper Roller Bearing Kit		1
9	422063	Bilya Yatığı / Housing Bearing Unit		1
10	423087	Tez Lastiği / Dust Cover		1
11	420035	Kapak Keçesi / Cover Plate Seal		1

MERITOR**424265****Kaliper Tamir Takımı Komple (Sol) / Caliper Repair Kit Full (Left)****DX 195 series****Orjinal No:****Cross No :****Tip / Application**

S.No.	Ekersan No.	Ürün Tanıtımı / Description	Ölçü/Dimension	Miktar/Qty.
1	424080	Lastik & Perno Takımı / Caliper Boot & Pin Repair Kit		1
2	424236	Kaliper Ayar Mekanizma Seti (Sol) / Caliper Adjusting Mechanism Set (Left)		1
3	424228	Kaliper Piston Tamir Takımı (Sol) / Caliper Piston Repair Kit (Left)		1
4	424230	Kaliper İtici Pleyt Tamir Takımı (Sol) / Caliper Push Plate Repair Kit (Left)		1
5	424104	Kaliper Dişli Birliği / Caliper Bridge Assembly	162,50 mm	1
6	424225	Kaliper Şaft Seti / Caliper Shaft Set		1
7	424238	Kaliper Şaft Ayar Kolu / Caliper Shaft Setting Lever	80 mm	1
8	424206	Kaliper Contası / Cover Plate Gasket		1
9	422063	Bilya Yatığı / Housing Bearing Unit		1
10	423087	Tez Lastiği / Dust Cover		1
11	420035	Kapak Keçesi / Cover Plate Seal		1

424284

DX 195 series

Kaliper Soft Tamir Takimi / Caliper Shaft Repair Kit

Orjinal No : 1620883 / 2350312 / 502210250 / 5813394043 / 3758443 / 153300

Cross No : ME 81294



S.No.	Ekarsan No.	Ürün Tanımı / Description	Ölçü/Dimension	Miktar/Qty.
1	424280	Kaliper Soft Seti / Caliper Shaft Set		1
2	424237	Kaliper Soft Yatağı / Caliper Shaft Bearing		1
3	424201	Kaliper Rulmanı / Caliper Bearing		1
4	423087	Toz Lastiği / Dust Cover		1
5	428036	Kapak Keçisi / Cover Plate Seal		1
6	425052	Tahliye Vidası / Screw		1

Tip / Application

DX.195.51, DX.195.52

MERITOR

422013

Kaliper Mekanizma Yuvası / Caliper Mechanism Slot

ELSA-1 series

Orjinal No:

Cross No :



Tip / Application

S.No.	Ekarsan No.	Ürün Tanıtımı / Description	Ölçü/Dimension	Miktar/Qty.
1	423601	Kaliper Mekanizma Yuvası / Caliper Mechanism Slot	Ø 36xØx14 mm	2

MERITOR

424100

Kaliper Lastik & Perno Takımı / Caliper Boot & Pin Repair Kit

ELSA-1 series

Orjinal No: 0209028017 / 0209028020 / 0209028021

Cross No : AK K1182



Tip / Application

S.No.	Ekarsan No.	Ürün Tanıtımı / Description	Ölçü/Dimension	Miktar/Qty.
1	424003	Kaliper Peması / Caliper Bolt	Ø 35x135 mm	1
2	424004	Kaliper Peması /	Ø 35x73 mm	1
3	425001	Kaliper Vidası / Caliper Screw	M20x1,5x150 mm	1
4	425002	Kaliper Vidası / Caliper Screw	M20x1,5x90 mm	1
5	423050	Kaliper Toz Lastiği / Caliper Dust Cover		2
6	426008	Metal Buçuk / Bushing	Ø 48x37x35/33 mm	1
7	426009	Metal Buçuk / Bushing	Ø 35x38x38 mm	2
8	426013	Kaliper Yüzüğü / Caliper Ring	Ø 42x37x14 mm	2
9	426013	Kaliper Yüzüğü / Caliper Ring	Ø 42x37x14 mm	2
10	426012	Kaliper Yüzüğü / Caliper Ring	Ø 48x37x13,5 mm	1
11	426011	Kaliper Yüzüğü / Caliper Ring	Ø 39x37/36x15 mm	1

MERITOR

424101

Kaliper Perno Tamir Takımı / Caliper Pin Repair Kit

ELSA-1 series

Orjinal No:

Cross No :



Tip / Application

S.No.	Ekarsan No.	Ürün Tanıtımı / Description	Ölçü/Dimension	Miktar/Qty.
1	424003	Kaliper Peması / Caliper Bolt	Ø 35x135 mm	1
2	424004	Kaliper Peması /	Ø 35x73 mm	1
3	423021	Kaliper Toz Lastiği / Caliper Dust Cover		2
4	423050	Kaliper Toz Lastiği / Caliper Dust Cover		2
5	426008	Metal Buçuk / Bushing	Ø 48x37x35/33 mm	1
6	426009	Metal Buçuk / Bushing	Ø 35x38x38 mm	2
7	429009	Perno Tapası / Bolt Plug	Ø 45x34,5 mm	2
8	423023	Kauçuk Borç / Rubber Bush		8
9	426012	Kaliper Yüzüğü / Caliper Ring	Ø 48x37x13,5 mm	1
10	426011	Kaliper Yüzüğü / Caliper Ring	Ø 39x37/36x15 mm	1

ELSA 1 SERIES

424102

Perno Tamir Takimi / Caliper Pin Repair Kit

ELSA-1 series

Orjinal No:

Cross No :



S.No.	Ekersan No.	Ürün Tanıtımı / Description	Ölçü/Dimension	Miktar/Qty.
1	424013	Kaliper Perno / Caliper Bolt	Ø 15x135 mm	1
2	424015	Kaliper Perno /	Ø 28,5x110 mm	1
3	425011	Kaliper Vidası / Caliper Screw	M20x1,5x150 mm	1
4	423021	Kaliper Toz Lastiği / Caliper Dust Cover		2
5	423050	Kaliper Toz Lastiği / Caliper Dust Cover		2
6	426009	Head Bar / Bushing	Ø 35x39x30 mm	2
7	429009	Perno Tapesi / Bolt Plug	Ø 45x34,5 mm	2
8	426011	Kaliper Yatağı / Caliper Ring	Ø 38x37/36x15 mm	1
9	426011	Kaliper Yatağı / Caliper Ring	Ø 38x37/36x15 mm	1
10	426010	Kaliper Yatağı / Caliper Ring	Ø 40x30x19 mm	1

Tip / Application

ELSA 1 SERIES

424103

Kaliper Lastik & Perno Takimi / Caliper Boot & Pin Repair Kit

ELSA-1 series

Orjinal No: 430000000

Cross No : MC 83103



S.No.	Ekersan No.	Ürün Tanıtımı / Description	Ölçü/Dimension	Miktar/Qty.
1	424013	Kaliper Perno / Caliper Bolt	Ø 15x135 mm	1
2	424015	Kaliper Perno /	Ø 28,5x110 mm	1
3	425011	Kaliper Vidası / Caliper Screw	M20x1,5x150 mm	1
4	423050	Kaliper Toz Lastiği / Caliper Dust Cover		2
5	426009	Head Bar / Bushing	Ø 35x39x30 mm	2
6	429009	Perno Tapesi / Bolt Plug	Ø 45x34,5 mm	2
7	423023	Kauçuk Borç / Rubber Bush		1
8	426010	Kaliper Yatağı / Caliper Ring	Ø 40x30x19 mm	1

Tip / Application

LRG 574 , 575 , 590 , 591 , 704 ,705

424104

Kaliper Ayar Disli Sacı / Caliper Locking Shim

ELSA-1 series

Orjinal No:

Cross No : 68321638P E30

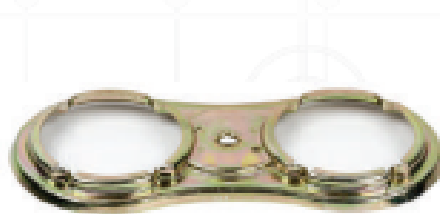

S.No.	Ekersan No.	Ürün Tanıtımı / Description	Ölçü/Dimension	Miktar/Qty.
1	424004	Kaliper Ayar Disli Sacı / Caliper Locking Shim		1

Tip / Application

MERITOR

424105

Ayar Mekanizması / Caliper Adjusting Mechanism (35 mm)

ELSA-1 series

Orjinal No:

Cross No :

S.No.	Ekensan No.	Ürün Tanımı / Description	Ölçü/Dimension	Miktar/Qty.
1	424105	Ayar Mekanizması / Caliper Adjusting Mechanism (35 mm)	Ø 35 mm	1



Tip / Application

MERITOR

424106

Ayar Dislisi Sağ / Caliper Adjusting Gear (35 mm) Right

ELSA-1 series

Orjinal No:

Cross No :

S.No.	Ekensan No.	Ürün Tanımı / Description	Ölçü/Dimension	Miktar/Qty.
1	424106	Ayar Dislisi Sağ / Caliper Adjusting Gear (35 mm) Right	Ø 35 mm	1



Tip / Application

L8G 542, 570, 574, 576, 586, 588, 590, 616, 632, 642, 704, 752

MERITOR

424107

Ayar Dislisi Sol / Caliper Adjusting Gear (35 mm) Left

ELSA-1 series

Orjinal No:

Cross No :

S.No.	Ekensan No.	Ürün Tanımı / Description	Ölçü/Dimension	Miktar/Qty.
1	424107	Ayar Dislisi Sol / Caliper Adjusting Gear (35 mm) Left	Ø 35 mm	1



Tip / Application

L8G 543, 571, 575, 577, 587, 589, 591, 617, 633, 643, 705, 753

MERITOR**424108****Kaliper Ayar Disli Takimi - Sag / Caliper Adjusting Gear Set - Right****ELSA-1 series****Orjinal No:****Cross No :**

S.No.	Ekersan No.	Ürün Tanıtımı / Description	Ölçü/Dimension	Miktar/Qty.
1	424006	Ayar Disli Sag / Caliper Adjusting Gear (35 mm) Right	Ø 35 mm	2
2	424005	Ayar Mekanizması / Caliper Adjusting Mechanism (35 mm)	Ø 35 mm	1
3	422013	Kaliper Mekanizma Yuvası / Caliper Mechanism Slot	Ø 36x40x14 mm	1

Tip / Application

ELSA 1 SERIES

MERITOR**424108-1****Kaliper Ayar Disli Takimi - Sol / Caliper Adjusting Gear Set - Left****ELSA-1 series****Orjinal No:****Cross No :**

S.No.	Ekersan No.	Ürün Tanıtımı / Description	Ölçü/Dimension	Miktar/Qty.
1	424007	Ayar Disli Sol / Caliper Adjusting Gear (35 mm) Left	Ø 35 mm	2
2	424005	Ayar Mekanizması / Caliper Adjusting Mechanism (35 mm)	Ø 35 mm	1
3	422013	Kaliper Mekanizma Yuvası / Caliper Mechanism Slot	Ø 36x40x14 mm	1

Tip / Application

ELSA 1 SERIES

MERITOR**424109****Ayar Mekanizması / Caliper Adjusting Mechanism (37,5 mm)****ELSA-1 series****Orjinal No:****Cross No :**

S.No.	Ekersan No.	Ürün Tanıtımı / Description	Ölçü/Dimension	Miktar/Qty.
1	424009	Ayar Mekanizması / Caliper Adjusting Mechanism (37,5 mm)	Ø 37,5 mm	1

Tip / Application

MERITOR

424110

ELSA-1 series



Tip / Application

LRG 542, 570, 574, 576, 586, 588, 590, 616, 632, 642, 704, 752

Ayar Dislisi Sag / Caliper Adjusting Gear (37,5 mm) Right

Original No:

Cross No :

S.No.	Ekansan No.	Ürün Tanıtımı / Description	Ölçü/Dimension	Miktar/Qty.
1	424110	Ayar Dislisi Sag / Caliper Adjusting Gear (37,5 mm) Right	Ø 37,5 mm	1

MERITOR

424111

ELSA-1 series



Tip / Application

LRG 543, 571, 575, 577, 587, 589, 591, 617, 633, 643, 705, 753

Ayar Dislisi Sol / Caliper Adjusting Gear (37,5 mm) Left

Original No:

Cross No :

S.No.	Ekansan No.	Ürün Tanıtımı / Description	Ölçü/Dimension	Miktar/Qty.
1	424111	Ayar Dislisi Sol / Caliper Adjusting Gear (37,5 mm) Left	Ø 37,5 mm	1

MERITOR

424112

ELSA-1 series



Tip / Application

ELSA 1 SERIES

Kaliper Ayar Disli Takimi - Sag / Caliper Adjusting Gear Set - Right

Original No:

Cross No :

S.No.	Ekansan No.	Ürün Tanıtımı / Description	Ölçü/Dimension	Miktar/Qty.
1	424110	Ayar Dislisi Sag / Caliper Adjusting Gear (37,5 mm) Right	Ø 37,5 mm	2
2	424109	Ayar Mekanizması / Caliper Adjusting Mechanism (37,5 mm)	Ø 37,5 mm	1
3	422003	Kaliper Mekanizma Yuvası / Caliper Mechanism Slot	Ø 36xØ14 mm	1

MERITOR

424112-1

ELSA-1 series



Tip / Application

ELSA 1 SERIES

Kaliper Ayar Dişli Takımı - Sol / Caliper Adjusting Gear Set - Left

Orjinal No:

Cross No :

S.No.	Ekarsan No.	Ürün Tanıtımı / Description	Ölçü/Dimension	Miktar/Qty.
1	424011	Ayar Dişli Sol / Caliper Adjusting Gear (37,5 mm) Left	Ø 37,5 mm	2
2	424009	Ayar Mekanizması / Caliper Adjusting Mechanism (37,5 mm)	Ø 37,5 mm	1
3	422013	Kaliper Mekanizma Yuvası / Caliper Mechanism Slot	Ø 36xØ14 mm	1

MERITOR

424113

ELSA-1 series

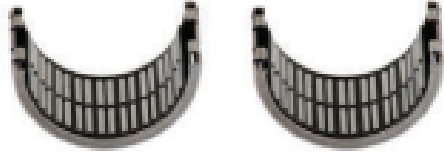

Tip / Application

ALL DUCO AND ELSA SERIES

Kaliper Masura Bilya Takımı / Caliper Roller Bearing Set

Orjinal No: 3062281

Cross No :

S.No.	Ekarsan No.	Ürün Tanıtımı / Description	Ölçü/Dimension	Miktar/Qty.
1	423602	Kaliper Masura Bilya / Caliper Roller Bearing		2

MERITOR

424114

ELSA-1 series

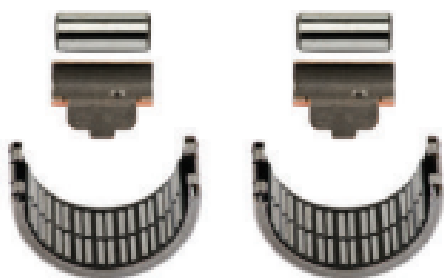

Tip / Application

ALL DUCO AND ELSA SERIES

Kaliper Masura Bilya Takımı / Caliper Roller Bearing Set

Orjinal No: 3062282

Cross No : 94112

S.No.	Ekarsan No.	Ürün Tanıtımı / Description	Ölçü/Dimension	Miktar/Qty.
1	426023	Bilya Yatağı Burcu /		2
2	426024	Bilya / Ball Bearing	Ø 16x38 mm	2
3	423602	Kaliper Masura Bilya / Caliper Roller Bearing		1

MERITOR**424115**

Kaliper Masura Bilya Yatagi (Sag) / Caliper Lever (Right)

ELSA-1 series

Orjinal No:

Cross No :



S.No.	Ekersan No.	Ürün Tanıtımı / Description	Ölçü/Dimension	Miktar/Qty.
1	424244	Masura Bilya Yatagi Sag / Caliper Lever (Right)		1
2	426023	Bilya Yatak Burcu /		2
3	426024	Bilya / Ball Bearing	Ø 16x38 mm	2

Tip / Application

ELSA 1 SERIES

MERITOR**424116**

Kaliper Masura Bilya Yatagi (Sol) / Caliper Lever (Left)

ELSA-1 series

Orjinal No:

Cross No :



S.No.	Ekersan No.	Ürün Tanıtımı / Description	Ölçü/Dimension	Miktar/Qty.
1	424245	Masura Bilya Yatagi Sol / Caliper Lever (Left)		1
2	426023	Bilya Yatak Burcu /		2
3	426024	Bilya / Ball Bearing	Ø 16x38 mm	2

Tip / Application

ELSA 1 SERIES

MERITOR**424124**

Kaliper Yayi Sag / Caliper Spring (Right)

ELSA-1 series

Orjinal No:

Cross No :



S.No.	Ekersan No.	Ürün Tanıtımı / Description	Ölçü/Dimension	Miktar/Qty.
1	424124	Kaliper Yayi Sag / Caliper Spring (Right)		1

Tip / Application

LRG 570, 574, 576, 586, 588, 590, 616, 704

MERITOR**424124-1****Kaliper Yay Takimi (Sag) / Caliper Spring Kit (Right)****ELSA-1 series****Orjinal No:****Cross No :**

S.No.	Ekersan No.	Ürün Tanıtımı / Description	Ölçü/Dimension	Miktar/Qty.
1	424124	Kaliper Yayı Sag / Caliper Spring (Right)		1
2	428029	Sabitleme Sacı /		1
3	428030	Pimmin Tutucu / Pin Holder		1
4	428031	Yay Tutucu / Spring Holder		1
5	425042	Vida Screw		1

Tip / Application

LRG 570, 574, 576, 586, 588, 590, 616, 704

MERITOR**424125****Kaliper Yayı Sol / Caliper Spring (Left)****ELSA-1 series****Orjinal No:****Cross No :**

S.No.	Ekersan No.	Ürün Tanıtımı / Description	Ölçü/Dimension	Miktar/Qty.
1	424125	Kaliper Yayı Sol / Caliper Spring (Left)		1

Tip / Application

LRG 571, 575, 577, 587, 589, 591, 617, 705

MERITOR**424125-1****Kaliper Yay Takimi (Sol) / Caliper Spring Kit (Left)****ELSA-1 series****Orjinal No:****Cross No :**

S.No.	Ekersan No.	Ürün Tanıtımı / Description	Ölçü/Dimension	Miktar/Qty.
1	424125	Kaliper Yayı Sol / Caliper Spring (Left)		1
2	428029	Sabitleme Sacı /		1
3	428030	Pimmin Tutucu / Pin Holder		1
4	428031	Yay Tutucu / Spring Holder		1
5	425042	Vida Screw		1

Tip / Application

LRG 570, 574, 576, 586, 588, 590, 616, 704

424144

Kaliper Toz Lastigi Set / Caliper Dust Cover Set

ELSA-1 series

Orjinal No: 6259028036

Cross No : SF1156



S.No.	Ekersan No.	Ürün Tanıtımı / Description	Ölçü/Dimension	Miktar/Qty.
1	423021	Kaliper Toz Lastigi / Caliper Dust Cover		2

Tip / Application

424157

Mekanizma Yatagi Sol / Caliper Adjusting Mechanism (Left)

ELSA-1 series

Orjinal No:

Cross No :



S.No.	Ekersan No.	Ürün Tanıtımı / Description	Ölçü/Dimension	Miktar/Qty.
1	424157	Mekanizma Yatagi Sol / Caliper Adjusting Mechanism (Left)		1

Tip / Application

LRG 571, 575, 577, 587, 589, 591, 617, 705

424158

Mekanizma Yatagi Sag / Caliper Adjusting Mechanism (Right)

ELSA-1 series

Orjinal No:

Cross No :



S.No.	Ekersan No.	Ürün Tanıtımı / Description	Ölçü/Dimension	Miktar/Qty.
1	424158	Mekanizma Yatagi Sag / Caliper Adjusting Mechanism (Right)		1

Tip / Application

LRG 570, 574, 576, 586, 588, 590, 616, 704

MERITOR**424159**

Kaliper Ayar Mekanizması / Caliper Adjusting Mechanism

ELSA-1 series

Orjinal No:

Cross No :



S.No.	Ekersan No.	Ürün Tanıtımı / Description	Ölçü/Dimension	Miktar/Qty.
1	423041	Mekanizma / Mechanism		1
2	428024	Küçük Sekman / O-ring		5
3	428025	Küçük Sekman / O-ring		4
4	428032	Çift Yataklı Kapak Pulu / Washer Double Side		1

Tip / Application

MERITOR**424204**

Kaliper Contası / Caliper Gasket

ELSA-1 series

Orjinal No:

Cross No :



S.No.	Ekersan No.	Ürün Tanıtımı / Description	Ölçü/Dimension	Miktar/Qty.
1	424204	Kaliper Contası / Caliper Gasket		1

Tip / Application

MERITOR**424205**

Kaliper Contası / Cover Plate Gasket

ELSA-1 series

Orjinal No:

Cross No :



S.No.	Ekersan No.	Ürün Tanıtımı / Description	Ölçü/Dimension	Miktar/Qty.
1	424205	Kaliper Contası / Cover Plate Gasket		1

Tip / Application

MERITOR

424206

Kaliper Contası / Cover Plate Gasket

ELSA-1 series

Original No:

Cross No :



S.No.	Ekersan No.	Ürün Tanıtımı / Description	Ölçü/Dimension	Miktar/Qty.
1	424206	Kaliper Contası / Cover Plate Gasket		1

Tip / Application

0

MERITOR

424213

Kaliper Masura Bilya Takımı / Caliper Roller Bearing Set

ELSA-1 series

Original No:

Cross No : 54898

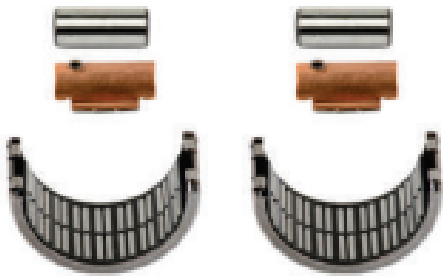

S.No.	Ekersan No.	Ürün Tanıtımı / Description	Ölçü/Dimension	Miktar/Qty.
1	426028	Bilya Yatağı Burcu /		2
2	426024	Bilya / Ball Bearing	Ø 16x8 mm	2
3	423602	Kaliper Masura Bilya / Caliper Roller Bearing		1

Tip / Application

ALL DUCO AND ELSA SERIES

MERITOR

424221

Kaliper Toz Lastığı Seti / Caliper Dust Cover Set

ELSA-1 series

Original No:

Cross No : 54853



S.No.	Ekersan No.	Ürün Tanıtımı / Description	Ölçü/Dimension	Miktar/Qty.
1	423050	Kaliper Toz Lastığı / Caliper Dust Cover		2

Tip / Application

424244

Masura Bilya Yatagi Sag / Caliper Lever (Right)

ELSA-1 series

Orjinal No: 3052258 / 6510259 / 2202753

Cross No :



S.No.	Ekresan No.	Ürün Tanımı / Description	Ölçü/Dimension	Miktar/Qty.
1	424244	Masura Bilya Yatagi Sag / Caliper Lever (Right)		1

Tip / Application

LRG 570, 574, 576, 586, 588, 590, 616, 704

424245

Masura Bilya Yatagi Sol / Caliper Lever (Left)

ELSA-1 series

Orjinal No: 3052259 / 6510260 / 2202754

Cross No :



S.No.	Ekresan No.	Ürün Tanımı / Description	Ölçü/Dimension	Miktar/Qty.
1	424245	Masura Bilya Yatagi Sol / Caliper Lever (Left)		1

Tip / Application

LRG 571, 575, 577, 587, 589, 591, 617, 705

424246

Kaliper İpat Tutucu Takimi / Caliper Pad Retainer Kit

ELSA-1 series

Orjinal No:

Cross No : ME 61262

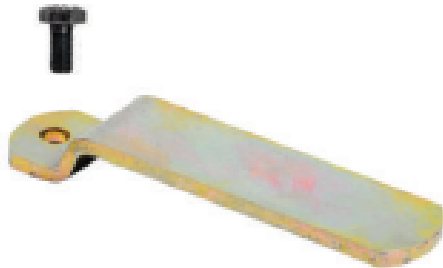

S.No.	Ekresan No.	Ürün Tanımı / Description	Ölçü/Dimension	Miktar/Qty.
1	425681	Kaliper İpat Tutucu / Caliper Pad Retainer		1

Tip / Application

ELSA 1 SERIES

MERITOR

424269

Kaliper Tamir Takimi Komple (Sag) / Caliper Repair Kit Full (Right)

ELSA-1 series

Orjinal No:

Cross No :



S.No.	Ekersan No.	Ürün Tanımı / Description	Ölçü/Dimension	Miktar/Qty.
1	424102	Perno Tamir Takimi / Caliper Pin Repair Kit		1
2	424112	Kaliper Ayar Dişli Takimi - Sag / Caliper Adjusting Gear Set - Right	Ø 32,5 mm	1
3	424158	Mekanizma Yatagi Sag / Caliper Adjusting Mechanism (Right)		1
4	424124-1	Kaliper Yay Takimi (Sag) / Caliper Spring Kit (Right)		1
5	424159	Kaliper Ayar Mekanizması / Caliper Adjusting Mechanism		1
6	424114	Kaliper Husuro Bilya Takimi / Caliper Roller Bearing Set		1
7	424104	Kaliper Ayar Dişli Sacı / Caliper Locking Shim		1
8	424204	Kaliper Contası / Caliper Gasket		1

Tip / Application

MERITOR

424270

Kaliper Tamir Takimi Komple (Sol) / Caliper Repair Kit Full (Left)

ELSA-1 series

Orjinal No:

Cross No :



S.No.	Ekersan No.	Ürün Tanımı / Description	Ölçü/Dimension	Miktar/Qty.
1	424102	Perno Tamir Takimi / Caliper Pin Repair Kit		1
2	424112-1	Kaliper Ayar Dişli Takimi - Sol / Caliper Adjusting Gear Set - Left	Ø 32,5 mm	1
3	424157	Mekanizma Yatagi Sol / Caliper Adjusting Mechanism (Left)		1
4	424125-1	Kaliper Yay Takimi (Sol) / Caliper Spring Kit (Left)		1
5	424159	Kaliper Ayar Mekanizması / Caliper Adjusting Mechanism		1
6	424114	Kaliper Husuro Bilya Takimi / Caliper Roller Bearing Set		1
7	424104	Kaliper Ayar Dişli Sacı / Caliper Locking Shim		1
8	424643	Kaliper Toz Lastiği Set / Caliper Dust Cover Set		1

Tip / Application

MERITOR

424271

Kaliper Tamir Takimi Komple (Sag) / Caliper Repair Kit Full (Right)

ELSA-1 series

Orjinal No:

Cross No :



S.No.	Ekersan No.	Ürün Tanımı / Description	Ölçü/Dimension	Miktar/Qty.
1	424102	Perno Tamir Takimi / Caliper Pin Repair Kit		1
2	424108	Kaliper Ayar Dişli Takimi - Sag / Caliper Adjusting Gear Set - Right	Ø 35 mm	1
3	424158	Mekanizma Yatagi Sag / Caliper Adjusting Mechanism (Right)		1
4	424124-1	Kaliper Yay Takimi (Sag) / Caliper Spring Kit (Right)		1
5	424159	Kaliper Ayar Mekanizması / Caliper Adjusting Mechanism		1
6	424114	Kaliper Husuro Bilya Takimi / Caliper Roller Bearing Set		1
7	424104	Kaliper Ayar Dişli Sacı / Caliper Locking Shim		1
8	424206	Kaliper Contası / Cover Plate Gasket		1

Tip / Application

424272

Kaliper Tamir Takimi Komple (Sol) / Caliper Repair Kit Full (Left)

ELSA-1 series

Orjinal No:

Cross No :



S.No.	Ekersan No.	Ürün Tanıtımı / Description	Ölçü/Dimension	Miktar/Qty.
1	424002	Perno Tamir Takimi / Caliper Pin Repair Kit		1
2	424108-1	Kaliper Ayar Dişi Takimi - Sol / Caliper Adjusting Gear Set - Left	Ø 35 mm	1
3	424157	Mekanizma Yatagi Sol / Caliper Adjusting Mechanism (Left)		1
4	424125-1	Kaliper Yay Takimi (Sol) / Caliper Spring Kit (Left)		1
5	424059	Kaliper Ayar Mekanizması / Caliper Adjusting Mechanism		1
6	424014	Kaliper Masura Dilya Takimi / Caliper Roller Bearing Set		1
7	424004	Kaliper Ayar Dişi Sacı / Caliper Locking Shim		1
8	424204	Kaliper Çantası / Caliper Basket		1

Tip / Application

MERITOR**421005****Kaliper Kapak Contası / Cover Plate Gasket****ELSA-2 195-225 series**

Orjinal No:

Cross No :

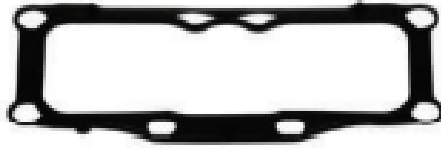

S.No.	Ekarsan No.	Ürün Tanıtımı / Description	Ölçü/Dimension	Miktar/Qty.
1	421005	Kaliper Kapak Contası / Cover Plate Gasket		1

Tip / Application

ALL ELSA 2, ELSA195, ELSA 225 SERIES

MERITOR**424113****Kaliper Masura Bilya Takımı / Caliper Roller Bearing Set****ELSA-2 195-225 series**

Orjinal No: 3092381

Cross No :

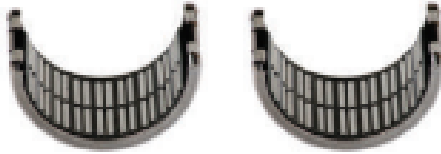

S.No.	Ekarsan No.	Ürün Tanıtımı / Description	Ölçü/Dimension	Miktar/Qty.
1	423602	Kaliper Masura Bilya / Caliper Roller Bearing		1

Tip / Application

ALL DUCO AND ELSA SERIES

MERITOR**424114****Kaliper Masura Bilya Takımı / Caliper Roller Bearing Set****ELSA-2 195-225 series**

Orjinal No: 3092329

Cross No : 54112

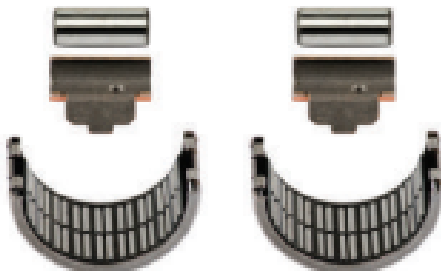

S.No.	Ekarsan No.	Ürün Tanıtımı / Description	Ölçü/Dimension	Miktar/Qty.
1	426023	Bilya Yatağı Burcu /		2
2	426024	Bilya / Ball Bearing	Ø 16x8 mm	2
3	423602	Kaliper Masura Bilya / Caliper Roller Bearing		1

Tip / Application

ALL DUCO AND ELSA SERIES

424117

Kaliper Perno Tamir Takimi / Caliper Pin Repair Kit

ELSA-2 195-225 series

Orjinal No:

Cross No :



S.No.	Ekersan No.	Ürün Tanıtımı / Description	Ölçü/Dimension	Miktar/Qty.
1	424016	Kaliper Pernosu / Caliper Bolt	Ø 35x144 mm	1
2	424017	Kaliper Pernosu /	Ø 31x84 mm	1
3	425014	Kaliper Vidası / Caliper Screw	M18x1,5x150 mm	1
4	425015	Kaliper Vidası / Caliper Screw	M18x1,5x90 mm	1
5	426016	Kaliper Burcu / Caliper Bush	Ø 31x42x45 mm	1
6	423022	Toz Lestigi / Dust Cover		2
7	423025	Toz Lestigi / Dust Cover		2
8	426013	Kaliper Yüzgeci / Caliper Ring	Ø 42x37x14 mm	1
9	429010	Perno Tapası / Bolt Plug	Ø 45x28 mm	2
10	426013	Kaliper Yüzgeci / Caliper Ring	Ø 42x37x14 mm	1

Tip / Application

ELSA 195, 225 SERIES

424118

Kaliper Perno Tamir Takimi / Caliper Pin Repair Kit

ELSA-2 195-225 series

Orjinal No:

Cross No :



S.No.	Ekersan No.	Ürün Tanıtımı / Description	Ölçü/Dimension	Miktar/Qty.
1	424016	Kaliper Pernosu / Caliper Bolt	Ø 35x144 mm	1
2	424017	Kaliper Pernosu /	Ø 31x84 mm	1
3	426014	Kaliper Burcu / Caliper Bush	Ø 31x42x45 mm	1
4	423022	Toz Lestigi / Dust Cover		2
5	423025	Toz Lestigi / Dust Cover		2
6	426009	Head Bar / Bushing	Ø 35x39x30 mm	2
7	429010	Perno Tapası / Bolt Plug	Ø 45x28 mm	2
8	426009	Head Bar / Bushing	Ø 35x39x30 mm	2

Tip / Application

424119

Kaliper Perno Tamir Takimi / Caliper Pin Repair Kit

ELSA-2 195-225 series

Orjinal No:

Cross No :



S.No.	Ekersan No.	Ürün Tanıtımı / Description	Ölçü/Dimension	Miktar/Qty.
1	424018	Kaliper Pernosu / Caliper Bolt	Ø 35x128 mm	1
2	424019	Kaliper Pernosu Oval /	Ø 31/35x66 mm	1
3	425011	Kaliper Vidası / Caliper Screw	M20x1,5x150 mm	1
4	425012	Kaliper Vidası / Caliper Screw	M20x1,5x90 mm	1
5	423022	Toz Lestigi / Dust Cover		2
6	426009	Head Bar / Bushing	Ø 35x39x30 mm	3
7	426009	Head Bar / Bushing	Ø 35x39x30 mm	3
8	429010	Perno Tapası / Bolt Plug	Ø 45x28 mm	2

Tip / Application

ELSA 195 / 225

424120

Perno Tamir Takimi / Caliper Pin Repair Kit

ELSA-2 195-225 series

Original No : 50035070

Cross No : MC 01084



S.No.	Ekersan No.	Ürün Tanıtımı / Description	Ölçü/Dimension	Miktar/Qty.
1	424008	Kaliper Pernoşu / Caliper Bolt	Ø 35x128 mm	1
2	424009	Kaliper Pernoşu Döş /	Ø 13/35x66 mm	1
3	425011	Kaliper Vidası / Caliper Screw	M20x1,5x150 mm	1
4	425012	Kaliper Vidası / Caliper Screw	M20x1,5x90 mm	1
5	429022	Toz Lastiği / Dust Cover		2
6	429009	Perno Tapası / Bolt Plug	Ø 45x28 mm	2

Tip / Application

LRG 546, 547, 580, 581, 582, 583

424123

Perno Tamir Takimi / Caliper Pin Repair Kit

ELSA-2 195-225 series

Original No : 02589028025 / 500386075 / 0247912

Cross No : MC 01349MC 01143



S.No.	Ekersan No.	Ürün Tanıtımı / Description	Ölçü/Dimension	Miktar/Qty.
1	424006	Kaliper Pernoşu / Caliper Bolt	Ø 35x144 mm	1
2	424007	Kaliper Pernoşu /	Ø 31x64 mm	1
3	425004	Kaliper Vidası / Caliper Screw	M18x1,5x150 mm	1
4	425005	Kaliper Vidası / Caliper Screw	M18x1,5x90 mm	1
5	429022	Toz Lastiği / Dust Cover		2
6	429011	Perno Tapası / Bolt Plug	Ø 44x17,5 mm	2
7	426015	Metal Buz / Bushing	Ø 31x33x42/30 mm	1
8	429008	Perno Tapası / Bolt Plug	Ø 45x28 mm	2
9	426013	Kaliper Yüzüğü / Caliper Ring	Ø 42x27x14 mm	2
10	425013	Wide Screw	M16x1,5x90 mm	4
11	425044	Wide Screw	M10x1,25x20 mm	1

Tip / Application

424143

Kaliper Toz Lastiği Seti / Caliper Dust Cover Set

ELSA-2 195-225 series

Original No : 02589028024 / 02589028027 / 5003940388 / 3892370 / 3877352

Cross No : MC 011396832485-IP 010



S.No.	Ekersan No.	Ürün Tanıtımı / Description	Ölçü/Dimension	Miktar/Qty.
1	429024	Toz Lastiği / Dust Cover		2

Tip / Application

ELSA 195 / 225

424149

ELSA-2 195-225 series

Kaliper Toz Lastığı Set / Caliper Dust Cover Set

Orjinal No:

Cross No :



S.No.	Ekersan No.	Ürün Tanıtımı / Description	Ölçü/Dimension	Miktar/Qty.
1	423025	Toz Lastığı / Dust Cover		1

Tip / Application

424150

ELSA-2 195-225 series

Kaliper Ayar Mekanizma Takımı / Caliper Adjusting Mechanism Set

Orjinal No:

Cross No :

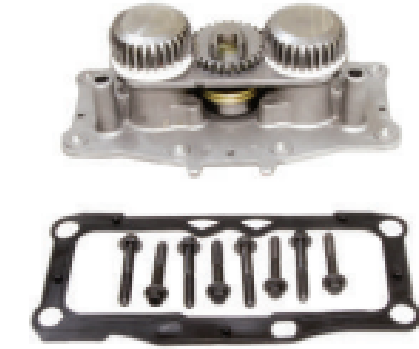

S.No.	Ekersan No.	Ürün Tanıtımı / Description	Ölçü/Dimension	Miktar/Qty.
1	424152	Mekanizma Kapagi / Caliper Adjusting Mechanism Cap		1
2	424251	Ayar Mekanizması / Caliper Adjusting Mechanism		1
3	424154	Kaliper Ayar Dişliği / Caliper Adjusting Gear (48,5 mm)	Ø 48,5 mm	2
4	425023	Kaliper Videsi / Caliper Screw	M8x1,25x45 mm	4
5	421005	Kaliper Kapak Contası / Cover Plate Gasket		1

Tip / Application

ELSA 195 / 225

424151

ELSA-2 195-225 series

Mekanizma Kapagi / Caliper Adjusting Mechanism Cap

Orjinal No:

Cross No :

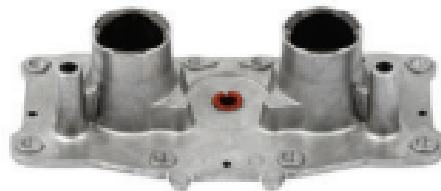

S.No.	Ekersan No.	Ürün Tanıtımı / Description	Ölçü/Dimension	Miktar/Qty.
1	424151	Mekanizma Kapagi / Caliper Adjusting Mechanism Cap		1

Tip / Application

ALL ELSA 2, ELSA195, ELSA 225 SERIES

MERITOR

424152

Mekanizma Kapagi / Caliper Adjusting Mechanism Cap

ELSA-2 195-225 series

Orjinal No:

Cross No :

S.No.	Ekersan No.	Ürün Tanıtımı / Description	Ölçü/Dimension	Miktar/Qty.
1	424152	Mekanizma Kapagi / Caliper Adjusting Mechanism Cap		1



Tip / Application

ALL ELSA 2, ELSA195, ELSA 225 SERIES

MERITOR

424153

Ayar Mekanizması / Caliper Adjusting Mechanism

ELSA-2 195-225 series

Orjinal No:

Cross No :

S.No.	Ekersan No.	Ürün Tanıtımı / Description	Ölçü/Dimension	Miktar/Qty.
1	424153	Ayar Mekanizması / Caliper Adjusting Mechanism		1



Tip / Application

ELSA, 195, 225 SERIES

MERITOR

424154

Kaliper Ayar Dislisi / Caliper Adjusting Gear (49,5 mm)

ELSA-2 195-225 series

Orjinal No:

Cross No :

S.No.	Ekersan No.	Ürün Tanıtımı / Description	Ölçü/Dimension	Miktar/Qty.
1	424154	Kaliper Ayar Dislisi / Caliper Adjusting Gear (49,5 mm)	Ø 49,5 mm	1

49,5 mm



Tip / Application

ELSA, 195, 225 SERIES

MERITOR

424154-1

Kaliper Ayar Dislisi (49,5 mm) / Caliper Adjusting Gear (49,5 mm)

ELSA-2 195-225 series

Orjinal No:

Cross No :



S.No.	Ekarsan No.	Ürün Tanıtımı / Description	Ölçü/Dimension	Miktar/Qty.
1	424054	Kaliper Ayar Dislisi / Caliper Adjusting Gear (49,5 mm)	Ø 49,5 mm	2

Tip / Application

ELSA, 195, 225 SERIES

MERITOR

424155

Kaliper Ayar Dislisi (Sağ) / Caliper Adjusting Gear (Right)

ELSA-2 195-225 series

Orjinal No:

Cross No :



S.No.	Ekarsan No.	Ürün Tanıtımı / Description	Ölçü/Dimension	Miktar/Qty.
1	422009	Ayar Dislisi Sağ / Adjusting Gear (R)		1
2	427009	Yay / Spring		1

Tip / Application

ALL ELSA 2, ELSA195, ELSA 225 SERIES

MERITOR

424156

Kaliper Ayar Dislisi (Sol) / Caliper Adjusting Gear (Left)

ELSA-2 195-225 series

Orjinal No:

Cross No :



S.No.	Ekarsan No.	Ürün Tanıtımı / Description	Ölçü/Dimension	Miktar/Qty.
1	422040	Ayar Dislisi Sol / Adjusting Gear (L)		1

Tip / Application

ALL ELSA 2, ELSA195, ELSA 225 SERIES

MERITOR**424160**

Kaliper Masura Bilya Yatak Seti / Caliper Lever Set

ELSA-2 195-225 series

Orjinal No:

Cross No :



S.No.	Ekersan No.	Ürün Tanıtımı / Description	Ölçü/Dimension	Miktar/Qty.
1	423607	Masura Bilya Yatagi / Caliper Lever		1
2	426023	Bilya Yatak Burcu /		2
3	426024	Bilya / Ball Bearing	Ø 16x38 mm	2

Tip / Application

ALL ELSA 2, ELSA195, ELSA 225 SERIES

MERITOR**424182**

Kaliper Masura Bilya Yatak Seti / Caliper Lever Set

ELSA-2 195-225 series

Orjinal No:

Cross No :



S.No.	Ekersan No.	Ürün Tanıtımı / Description	Ölçü/Dimension	Miktar/Qty.
1	423608	Masura Bilya Yatagi / Caliper Lever		1
2	426023	Bilya Yatak Burcu /		2
3	426024	Bilya / Ball Bearing	Ø 16x38 mm	2

Tip / Application

ELSA 195, 225 SERIES

MERITOR**424183**

Kaliper Masura Bilya Yatagi (Radyal) / Caliper Lever (Radial)

ELSA-2 195-225 series

Orjinal No:

Cross No :



S.No.	Ekersan No.	Ürün Tanıtımı / Description	Ölçü/Dimension	Miktar/Qty.
1	423609	Masura Bilya Yatagi / Caliper Lever		1
2	426029	Bilya Yatak Burcu /		2
3	426024	Bilya / Ball Bearing	Ø 16x38 mm	2

Tip / Application

ELSA 2

424191

Kaliper Bilya Yatakları / Caliper Bearing Caps

ELSA-2 195-225 series

Orjinal No:

Cross No :



S.No.	Ekersan No.	Ürün Tanıtımı / Description	Ölçü/Dimension	Miktar/Qty.
1	423603	Kaliper Bilya Yatağı / Caliper Bearing Cap		2

Tip / Application

ELSA 2, 195, 225 SERIES

424192

Kaliper Toz Lastik Takımı / Caliper Tappet Head

ELSA-2 195-225 series

Orjinal No: 5002860388

Cross No : MC K1308



S.No.	Ekersan No.	Ürün Tanıtımı / Description	Ölçü/Dimension	Miktar/Qty.
1	423024	Toz Lastiği / Dust Cover		2
2	425018	Kaliper Tappeti /		2
3	426006	Tapa Yüzüğü / Plug Ring	Ø 34x6,7 mm	2

Tip / Application

ELSA 2, 195, 225 SERIES

424193

Kaliper Mekanizma Ayar Keçeleri / Caliper Adjusting Mechanism Sealings

ELSA-2 195-225 series

Orjinal No:

Cross No :



S.No.	Ekersan No.	Ürün Tanıtımı / Description	Ölçü/Dimension	Miktar/Qty.
1	426031	Metel Bar / Bushing		2
2	426032	Metel Keçe /		2
3	426033	Kaleçe / Clamp		2

Tip / Application

ELSA 2, 195, 225 SERIES

MERITOR**424194****Kaliper Ayar Mekanizma Takimi / Caliper Adjusting Mechanism Set****ELSA-2 195-225 series****Orjinal No:****Cross No :**

S.No.	Ekersan No.	Ürün Tanımı / Description	Ölçü/Dimension	Miktar/Qty.
1	424195	Mekanizma Kapagi / Mechanism Cap		1
2	424251	Ayar Mekanizması / Caliper Adjusting Mechanism		1
3	424154	Kaliper Ayar Dislisi / Caliper Adjusting Gear (49.5 mm)	Ø 49,5 mm	2
4	425032	Kaliper Vidası / Caliper Screw	M8x1,5x45 mm	8
5	421007	Kaliper Kapak Contası / Cover Plate Gasket		1

Tip / Application

ELSA 195 / 225

MERITOR**424196****Kaliper Ayar Dislisi / Caliper Adjusting Gear****ELSA-2 195-225 series****Orjinal No:****Cross No :**

S.No.	Ekersan No.	Ürün Tanımı / Description	Ölçü/Dimension	Miktar/Qty.
1	422077	Kaliper Ayar Dislisi / Caliper Adjusting Gear		1

Tip / Application

ELSA 195, 225 SERIES

MERITOR**424198****Kaliper Perno Tamir Takimi / Caliper Pin Repair Kit****ELSA-2 195-225 series****Orjinal No:** 65240000 / 000100000**Cross No :** MC K1198

S.No.	Ekersan No.	Ürün Tanımı / Description	Ölçü/Dimension	Miktar/Qty.
1	424028	Kaliper Perno / Caliper Bolt	Ø 35x117 mm	1
2	424029	Kaliper Perno /	Ø 31x78 mm	1
3	425008	Kaliper Vidası / Caliper Screw	M18x1,5x117 mm	1
4	425036	Kaliper Vidası / Caliper Screw	M18x1,5x80 mm	1
5	426009	Metal Bıç / Bushing	Ø 35x36x38 mm	2
6	426015	Metal Bıç / Bushing	Ø 31x33x42/30 mm	1
7	423022	Toz Lastiği / Dust Cover		2
8	425025	Kaliper Vidası / Caliper Screw	M18x1,5x40 mm	4
9	425026	Kaliper Vidası / Caliper Screw	M14x1,5x40 mm	4
10	429011	Perno Tapesi / Plug Bolt		2
11	426021	Kaliper Yüzüğü / Ring	Ø 37x48x11 mm	2

Tip / Application

LRG 730, 731, 732, 733

VOLVO / RENAULT

424199

Kaliper Perno Tamir Takimi / Caliper Pin Repair Kit

ELSA-2 195-225 series

Orjinal No: 8529882

Cross No : MC 81317



S.No.	Ekensan No.	Ürün Tanımı / Description	Ölçü/Dimension	Miktar/Qty.
1	424020	Kaliper Pernosu / Caliper Bolt	Ø 35x117 mm	1
2	424030	Kaliper Pernosu /	Ø 31x117 mm	1
3	425018	Kaliper Vidası / Caliper Screw	M18x1,5x117 mm	2
4	426009	Metal Burg / Bushing	Ø 35x26x50 mm	2
5	426015	Metal Burg / Bushing	Ø 31x31x42/30 mm	2
6	423022	Toz Lastığı / Dust Cover		2
7	429011	Perno Tapası / Bolt Plug	Ø 44x17,5 mm	2
8	429029	Kaliper Vidası / Caliper Screw		4
9	426021	Kaliper Yüzüğü / Ring	Ø 37x40x11 mm	2

Tip / Application

ELSA 2

424200

Kaliper Civata Tamir Takimi / Caliper Bolt Repair Kit

ELSA-2 195-225 series

Orjinal No:

Cross No : MC 81318



S.No.	Ekensan No.	Ürün Tanımı / Description	Ölçü/Dimension	Miktar/Qty.
1	425018	Kaliper Vidası / Caliper Screw	M18x1,5x117 mm	1
2	429024	Kaliper Vidası / Caliper Screw	M14x1,5x40 mm	4
3	429025	Kaliper Vidası / Caliper Screw	M16x1,5x40 mm	4
4	423022	Toz Lastığı / Dust Cover		2
5	429011	Perno Tapası / Bolt Plug	Ø 44x17,5 mm	2

Tip / Application

ELSA 195 / 225

424203

Kaliper Keçesi / Caliper Seal

ELSA-2 195-225 series

Orjinal No:

Cross No :



S.No.	Ekensan No.	Ürün Tanımı / Description	Ölçü/Dimension	Miktar/Qty.
1	424203	Kaliper Keçesi / Caliper Seal		1

Tip / Application

ELSA 2, 195, 225 SERIES

MERITOR

424208

Seviye Gösterge Çubuğu / Caliper Indicator Bar

ELSA-2 195-225 series

Original No:

Cross No :

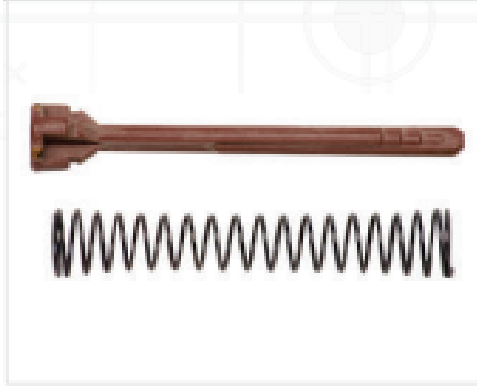

S.No.	Ekersan No.	Ürün Tanımı / Description	Ölçü/Dimension	Miktar/Qty.
1	424208	Seviye Gösterge Çubuğu / Caliper Indicator Bar		1

Tip / Application

ELSA 2, 195, 225 SERIES

MERITOR

424213

Kaliper Masura Bilya Takımı / Caliper Roller Bearing Set

ELSA-2 195-225 series

Original No:

Cross No : SH898

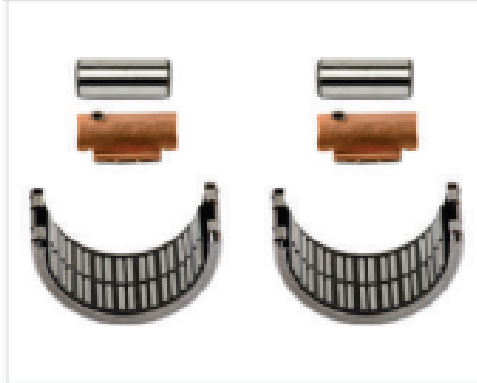

S.No.	Ekersan No.	Ürün Tanımı / Description	Ölçü/Dimension	Miktar/Qty.
1	426029	Bilya Yatağı (Burcu) /		2
2	426024	Bilya / Ball Bearing	Ø 16xØ 8 mm	2
3	423602	Kaliper Masura Bilya / Caliper Roller Bearing		1

Tip / Application

ALL DUCO AND ELSA SERIES

MERITOR

424247

Kaliper Perno Tamir Takımı / Caliper Pin Repair Kit

ELSA-2 195-225 series

Original No:

Cross No :



S.No.	Ekersan No.	Ürün Tanımı / Description	Ölçü/Dimension	Miktar/Qty.
1	424006	Kaliper Perno / Caliper Bolt	Ø 35x144 mm	1
2	424007	Kaliper Perno /	Ø 31x84 mm	1
3	425004	Kaliper Vidası / Caliper Screw	M18x1,5x150 mm	1
4	425005	Kaliper Vidası / Caliper Screw	M18x1,5x90 mm	1
5	426004	Kaliper Burcu / Caliper Bush	Ø 31xØ 2x45 mm	1
6	423022	Tez Lastiği / Dust Cover		2
7	426009	Metal Burç / Bushing	Ø 35xØ 8x38 mm	2
8	423025	Tez Lastiği / Dust Cover		2
9	426013	Kaliper Yüzüğü / Caliper Ring	Ø 42xØ 7x14 mm	1

Tip / Application

424248

Kaliper Civata ve Lastik Takimi / Caliper Screw And Boot Set

ELSA-2 195-225 series

Orjinal No: 500185078 / 500880782

Cross No : M1 81244



S.No.	Ekersan No.	Ürün Tanıtımı / Description	Ölçü/Dimension	Miktar/Qty.
1	423024	Toz Lastiği / Dust Cover		2
2	423022	Toz Lastiği / Dust Cover		2
3	429010	Perno Tapası / Bolt Plug	Ø 4x28 mm	2
4	424057	Kaliper kaçağı Piri / Caliper Seal		1
5	423026	Plastik Tapa / Plastic Plug		1
6	429013	Kaliper Vidası / Caliper Screw	M14x1,5x40 mm	4

Tip / Application

AİL ELSA 2, ELSA195, ELSA 225 SERIES

424249

Perno Tamir Takimi / Caliper Pin Repair Kit

ELSA-2 195-225 series

Orjinal No:

Cross No : M1 81254

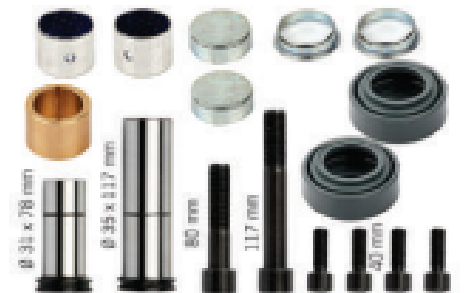

S.No.	Ekersan No.	Ürün Tanıtımı / Description	Ölçü/Dimension	Miktar/Qty.
1	424005	Kaliper Perno / Caliper Bolt	Ø 35x117 mm	1
2	424006	Kaliper Perno /	Ø 31x78 mm	1
3	425018	Kaliper Vidası / Caliper Screw	M18x1,5x117 mm	1
4	429026	Kaliper Vidası / Caliper Screw	M18x1,5x80 mm	1
5	429009	Metal Bar / Bushing	Ø 30x39x30 mm	2
6	426015	Metal Bar / Bushing	Ø 31x33x42/30 mm	1
7	423022	Toz Lastiği / Dust Cover		2
8	429010	Perno Tapası / Bolt Plug	Ø 4x28 mm	2
9	429024	Kaliper Vidası / Caliper Screw	M14x1,5x40 mm	4
10	426021	Kaliper Yüzge / Ring	Ø 31x40x11 mm	2

Tip / Application

424250

Kaliper Civata ve Lastik Takimi / Caliper Screw And Boot Set

ELSA-2 195-225 series

Orjinal No:

Cross No : M1 81253

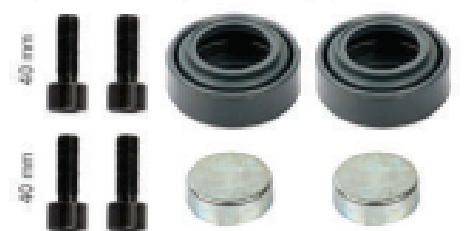

S.No.	Ekersan No.	Ürün Tanıtımı / Description	Ölçü/Dimension	Miktar/Qty.
1	423022	Toz Lastiği / Dust Cover		2
2	429011	Perno Tapası / Bolt Plug	Ø 4x17,5 mm	2
3	429024	Kaliper Vidası / Caliper Screw	M14x1,5x40 mm	4

Tip / Application

MERITOR**424251****Ayar Mekanizması / Caliper Adjusting Mechanism****ELSA-2 195-225 series****Orjinal No:****Cross No :**

S.No.	Ekersan No.	Ürün Tanıtımı / Description	Ölçü/Dimension	Miktar/Qty.
1	424251	Ayar Mekanizması / Caliper Adjusting Mechanism		1

Tip / Application

ALL ELSA 2, ELSA195, ELSA 225 SERIES

MERITOR**424253****Kaliper Ayar Mekanizma Kapak Takimi / Caliper Adjusting Mechanism Cap Set****ELSA-2 195-225 series****Orjinal No:****Cross No :**

S.No.	Ekersan No.	Ürün Tanıtımı / Description	Ölçü/Dimension	Miktar/Qty.
1	424250	Mekanizma Kapagi / Mechanism Cap		1
2	421010	Kaliper Kapak Contası /		1
3	425023	Kaliper Vidası / Caliper Screw	M8x1,25x45 mm	8

Tip / Application

ELSA 2, 195, 225 SERIES

MERITOR**424254****Kaliper Masura Bilya Yatak Seti / Caliper Lever Set****ELSA-2 195-225 series****Orjinal No:****Cross No :**

S.No.	Ekersan No.	Ürün Tanıtımı / Description	Ölçü/Dimension	Miktar/Qty.
1	423630	Masura Bilya Yatağı / Caliper Lever		1
2	426044	Bilya Yatak Burcu /		2
3	426034	Bilya / Ball Bearing	Ø 14x38 mm	2

Tip / Application

ELSA 195, 225 SERIES

MERITOR

424255

Kaliper Masura Bilya Yatagi / Caliper Lever

ELSA-2 195-225 series

Orjinal No:

Cross No :

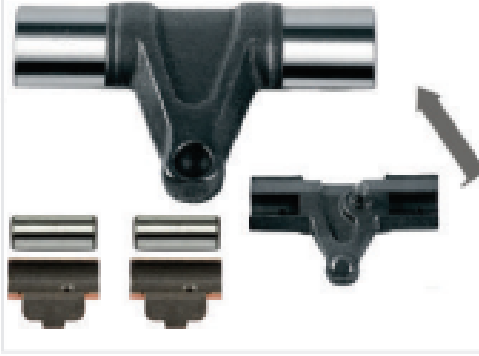

S.No.	Ekersan No.	Ürün Tanıtımı / Description	Ölçü/Dimension	Miktar/Qty.
1	423011	Masura Bilya Yatagi / Caliper Lever		1
2	426023	Bilya Yatağı Burcu /		2
3	426024	Bilya / Ball Bearing	Ø 16x38 mm	2

Tip / Application

ELSA, 195, 225 SERIES

MERITOR

424256

Kaliper Keçesi / Caliper Seal

ELSA-2 195-225 series

Orjinal No:

Cross No : 68123746P 870



S.No.	Ekersan No.	Ürün Tanıtımı / Description	Ölçü/Dimension	Miktar/Qty.
1	424256	Kaliper Keçesi / Caliper Seal		1

Tip / Application

ELSA 2, 195, 225 SERIES

MERITOR

424257

Kaliper keçesi Pimli / Caliper Seal

ELSA-2 195-225 series

Orjinal No:

Cross No : 6812374668123746P 870



S.No.	Ekersan No.	Ürün Tanıtımı / Description	Ölçü/Dimension	Miktar/Qty.
1	424257	Kaliper keçesi Pimli / Caliper Seal		1

Tip / Application

ELSA 2, 195, 225 SERIES

424259

Kaliper Ayar Mekanizma Kapak Takimi / Caliper Adjusting Mechanism Cap Set

ELSA-2 195-225 series

Original No:

Cross No :



S.No.	Ekersan No.	Ürün Tanıtımı / Description	Ölçü/Dimension	Miktar/Qty.
1	424252	Mekanizma Kapagi / Caliper Adjusting Mechanism Cap		1
2	421005	Kaliper Kapak Contol / Cover Plate Gasket		1
3	425023	Kaliper Vidası / Caliper Screw	M8x1,25x45 mm	3

Tip / Application

ALL ELSA 2, ELSA195, ELSA 225 SERIES

424275

Kaliper Tamir Takimi Komple (Sag) / Caliper Repair Kit Full (Right)

ELSA-2 195-225 series

Original No:

Cross No :



S.No.	Ekersan No.	Ürün Tanıtımı / Description	Ölçü/Dimension	Miktar/Qty.
1	424023	Perno Tamir Takimi / Caliper Pin Repair Kit		1
2	424259	Kaliper Ayar Mekanizma Kapak Takimi / Caliper Adjusting Mechanism Cap Set		1
3	424154-1	Kaliper Ayar Dişlisi (49,5 mm) / Caliper Adjusting Gear (49,5 mm)	Ø 49,5 mm	1
4	424251	Ayar Mekanizması / Caliper Adjusting Mechanism		1
5	424195	Kaliper Ayar Dişlisi (Sag) / Caliper Adjusting Gear (Right)		1
6	424014	Kaliper Masura Bilya Takimi / Caliper Roller Bearing Set		1
7	424191	Kaliper Bilya Yatakları / Caliper Bearing Caps		1
8	424043	Kaliper Toz Lastiği Set / Caliper Dust Cover Set		1
9	420208	Seviyeye Gösterge Çubuğu / Caliper Indicator Bar		1
10	424281	Kaliper Ayar Reçe Tamir Takimi / Caliper Adjuster Seal Repair Kit		1
11	424257	Kaliper Keçed Pimi / Caliper Seal		1

Tip / Application

424276

Kaliper Tamir Takimi Komple (Sol) / Caliper Repair Kit Full (Left)

ELSA-2 195-225 series

Original No:

Cross No :



S.No.	Ekersan No.	Ürün Tanıtımı / Description	Ölçü/Dimension	Miktar/Qty.
1	424023	Perno Tamir Takimi / Caliper Pin Repair Kit		1
2	424259	Kaliper Ayar Mekanizma Kapak Takimi / Caliper Adjusting Mechanism Cap Set		1
3	424154-1	Kaliper Ayar Dişlisi (49,5 mm) / Caliper Adjusting Gear (49,5 mm)	Ø 49,5 mm	1
4	424251	Ayar Mekanizması / Caliper Adjusting Mechanism		1
5	424195	Kaliper Ayar Dişlisi (Sol) / Caliper Adjusting Gear (Left)		1
6	424014	Kaliper Masura Bilya Takimi / Caliper Roller Bearing Set		1
7	424191	Kaliper Bilya Yatakları / Caliper Bearing Caps		1
8	424043	Kaliper Toz Lastiği Set / Caliper Dust Cover Set		1
9	420208	Seviyeye Gösterge Çubuğu / Caliper Indicator Bar		1
10	424281	Kaliper Ayar Reçe Tamir Takimi / Caliper Adjuster Seal Repair Kit		1
11	424257	Kaliper Keçed Pimi / Caliper Seal		1

Tip / Application

424277

Kaliper Tamir Takimi Komple (Sag) / Caliper Repair Kit Full (Right)

ELSA-2 195-225 series

Orjinal No:

Cross No :



S.No.	Ekersan No.	Ürün Tanıtımı / Description	Ölçü/Dimension	Miktar/Qty.
1	424220	Perno Tamir Takimi / Caliper Pin Repair Kit		1
2	424253	Kaliper Ayar Mekanizma Kapak Takimi / Caliper Adjusting Mechanism Cap Set		1
3	424282-1	Kaliper Ayar Dişlisi(47 mm) / Caliper Adjusting Gear (47 mm)	Ø 47 mm	1
4	424153	Ayar Mekanizması / Caliper Adjusting Mechanism		1
5	424155	Kaliper Ayar Dişlisi(Sag) / Caliper Adjusting Gear (Right)		1
6	424114	Kaliper Masura Bilya Takimi / Caliper Roller Bearing Set		1
7	424191	Kaliper Bilya Yatakları / Caliper Bearing Caps		1
8	424343	Kaliper Toz Lastiği Set / Caliper Dust Cover Set		1
9	424208	Seviyegösterge Çubuğu / Caliper Indicator Bar		1
10	424201	Kaliper Ayar Keçe Tamir Takimi / Caliper Adjuster Seal Repair Kit		1
11	424257	Kaliper keçesi Pimi / Caliper Seal		1

Tip / Application

424278

Kaliper Tamir Takimi Komple (Sol) / Caliper Repair Kit Full (Left)

ELSA-2 195-225 series

Orjinal No:

Cross No :



S.No.	Ekersan No.	Ürün Tanıtımı / Description	Ölçü/Dimension	Miktar/Qty.
1	424220	Perno Tamir Takimi / Caliper Pin Repair Kit		1
2	424253	Kaliper Ayar Mekanizma Kapak Takimi / Caliper Adjusting Mechanism Cap Set		1
3	424282-1	Kaliper Ayar Dişlisi(47 mm) / Caliper Adjusting Gear (47 mm)	Ø 47 mm	1
4	424153	Ayar Mekanizması / Caliper Adjusting Mechanism		1
5	424196	Kaliper Ayar Dişlisi(Sol) / Caliper Adjusting Gear (Left)		1
6	424114	Kaliper Masura Bilya Takimi / Caliper Roller Bearing Set		6
7	424191	Kaliper Bilya Yatakları / Caliper Bearing Caps		1
8	424343	Kaliper Toz Lastiği Set / Caliper Dust Cover Set		1
9	424208	Seviyegösterge Çubuğu / Caliper Indicator Bar		1
10	424201	Kaliper Ayar Keçe Tamir Takimi / Caliper Adjuster Seal Repair Kit		1
11	424257	Kaliper keçesi Pimi / Caliper Seal		1

Tip / Application

424279

Kaliper Tamir Takimi Komple / Caliper Repair Kit Full

ELSA-2 195-225 series

Orjinal No:

Cross No :



S.No.	Ekersan No.	Ürün Tanıtımı / Description	Ölçü/Dimension	Miktar/Qty.
1	424248	Perno Tamir Takimi / Caliper Pin Repair Kit		1
2	424283	Kaliper Ayar Mekanizma Kapak Takimi / Caliper Adjusting Mechanism Cap Set		1
3	424154-1	Kaliper Ayar Dişlisi(49,5 mm) / Caliper Adjusting Gear (49,5 mm)	Ø 49,5 mm	1
4	424251	Ayar Mekanizması / Caliper Adjusting Mechanism		1
5	424296	Kaliper Ayar Dişlisi / Caliper Adjusting Gear		1
6	424114	Kaliper Masura Bilya Takimi / Caliper Roller Bearing Set		6
7	424191	Kaliper Bilya Yatakları / Caliper Bearing Caps		1
8	424208	Seviyegösterge Çubuğu / Caliper Indicator Bar		1
9	424201	Kaliper Ayar Keçe Tamir Takimi / Caliper Adjuster Seal Repair Kit		1
10	424257	Kaliper keçesi Pimi / Caliper Seal		1

Tip / Application

MERITOR**424280**

Kaliper Toz Lastiği Set / Caliper Dust Cover Set

ELSA-2 195-225 series

Orjinal No:

Cross No :



S.No.	Ekersan No.	Ürün Tanıtımı / Description	Ölçü/Dimension	Miktar/Qty.
1	423022	Toz Lastiği / Dust Cover		2

Tip / Application

MERITOR**424281**

Kaliper Ayar Keçe Tamir Takimi / Caliper Adjuster Seal Repair Kit

ELSA-2 195-225 series

Orjinal No:

Cross No :



S.No.	Ekersan No.	Ürün Tanıtımı / Description	Ölçü/Dimension	Miktar/Qty.
1	423026	Plastik Tapa / Plastic Plug		1
2	426021	Kaliper Yüzüğü / Ring	Ø 37x48x11 mm	1
3	428034	Küçük Keçe / Seal Small		1

Tip / Application

ALL ELSA 2, ELSA195, ELSA 225 SERIES

MERITOR**424282**

Kaliper Ayar Dislisi / Caliper Adjusting Gear (47 mm)

ELSA-2 195-225 series

Orjinal No:

Cross No :



S.No.	Ekersan No.	Ürün Tanıtımı / Description	Ölçü/Dimension	Miktar/Qty.
1	424282	Kaliper Ayar Dislisi / Caliper Adjusting Gear (47 mm)	Ø 47 mm	1

Tip / Application

ELSA, 195, 225 SERIES

MERITOR

424282-1

Kaliper Ayar Dişlisi (47 mm) / Caliper Adjusting Gear (47 mm)

ELSA-2 195-225 series

Orjinal No:

Cross No :



S.No.	Ekensan No.	Ürün Tanıtımı / Description	Ölçü/Dimension	Miktar/Qty.
1	424282	Kaliper Ayar Dişlisi / Caliper Adjusting Gear (47 mm)	Ø 47 mm	2

Tip / Application

ELSA, 195, 225 SERIES

MERITOR

424283

Kaliper Ayar Mekanizma Kapak Takımı / Caliper Adjusting Mechanism Cap Set

ELSA-2 195-225 series

Orjinal No:

Cross No :



S.No.	Ekensan No.	Ürün Tanıtımı / Description	Ölçü/Dimension	Miktar/Qty.
1	424283	Mekanizma Kapagi / Mechanism Cap		1
2	420007	Kaliper Kapak Contası / Cover Plate Gasket		1
3	425032	Kaliper Vidası / Caliper Screw	M8x1,5x45 mm	8

Tip / Application

ELSA 195, 225 SERIES

424121

Perno Tamir Takimi / Caliper Pin Repair Kit

LISA series

Orjinal No : 3000000 / 300000000

Cross No : 5H076



S.No.	Ekersan No.	Ürün Tanımı / Description	Ölçü/Dimension	Miktar/Qty.
1	424020	Kaliper Perno / Caliper Bolt	Ø 35x132 mm	1
2	424021	Kaliper Perno /	Ø 35x79 mm	1
3	425011	Kaliper Vidası / Caliper Screw	M20x1,5x150 mm	1
4	425002	Kaliper Vidası / Caliper Screw	M20x1,5x90 mm	1
5	429022	Toz Lastiği / Dust Cover		2
6	426009	Metal Bung / Bushing	Ø 35x18x18 mm	2
7	426006	Metal Bung / Bushing	Ø 35x18x41 mm	2
8	429036	Perno Tapası / Bolt Plug	Ø 45x42 mm	2
9	429011	Perno Tapası / Bolt Plug	Ø 44x17,5 mm	2
10	426008	Sekman / Circle	Ø 37x27x12 mm	2

Tip / Application

LRG 548, 549, 550, 551, 592, 593, 630, 631

424122

Kaliper Civata ve Tapa Takimi / Caliper Bolt & Cap Set

LISA series

Orjinal No :

Cross No : 5H021



S.No.	Ekersan No.	Ürün Tanımı / Description	Ölçü/Dimension	Miktar/Qty.
1	425011	Kaliper Vidası / Caliper Screw	M20x1,5x150 mm	1
2	425002	Kaliper Vidası / Caliper Screw	M20x1,5x90 mm	1
3	429011	Perno Tapası / Bolt Plug	Ø 44x17,5 mm	2

Tip / Application

LRG 548, 549, 550, 551, 592, 593, 630, 631

424161

Kaliper Ayar Dislisi (Sag) / Caliper Adjusting Gear (Right)

LISA series

Orjinal No :

Cross No : 5H074



S.No.	Ekersan No.	Ürün Tanımı / Description	Ölçü/Dimension	Miktar/Qty.
1	422042	Ayar Disisi Sag / Adjusting Gear (R)		1

Tip / Application

LRG 549, 551, 555, 593, 595, 631

MERITOR**424162**

LISA series

**Tip / Application**

LRG 548, 550, 554, 592, 594, 630

Kaliper Ayar Dislisi (Sol) / Caliper Adjusting Gear (Left)

Orjinal No:**Cross No :** 94003

S.No.	Ekersan No.	Ürün Tanıtımı / Description	Ölçü/Dimension	Miktar/Qty.
1	022063	Ayar Dislisi Sol / Adjusting Gear (L)		1

MERITOR**424163**

LISA series

**Tip / Application**

LRG 548, 550, 554, 592, 594, 630

Kaliper Ayar Mekanizması (Sol) / Caliper Adjusting Mechanism (Left)

Orjinal No:**Cross No :** 94113

S.No.	Ekersan No.	Ürün Tanıtımı / Description	Ölçü/Dimension	Miktar/Qty.
1	422019	Mekanizma Sol / Mechanism (L)		1
2	422021	Küçük Dişli /		1
3	427011	Yay / Spring		1

MERITOR**424164**

LISA series

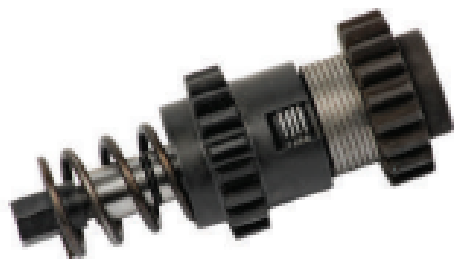
**Tip / Application**

LRG 549, 551, 555, 593, 595, 631

Kaliper Ayar Mekanizması (Sağ) / Caliper Adjusting Mechanism (Right)

Orjinal No:**Cross No :** 94114

S.No.	Ekersan No.	Ürün Tanıtımı / Description	Ölçü/Dimension	Miktar/Qty.
1	422020	Mekanizma Sağ / Mechanism (R)		1
2	422021	Küçük Dişli /		1

MERITOR**424189**

Kaliper Balata Tutucu / Caliper Push Plate

LISA series

Orjinal No:

Cross No :



S.No.	Ekensan No.	Ürün Tanımı / Description	Ölçü/Dimension	Miktar/Qty.
1	424189	Kaliper Balata Tutucu / Caliper Push Plate		1

Tip / Application

LR6 548, 549, 550, 551, 554, 555, 592, 593, 594, 595, 630, 631

MERITOR**424190**

Kaliper Rulman Takimi / Caliper Roller Bearing Set

LISA series

Orjinal No:

Cross No : 5H831



S.No.	Ekensan No.	Ürün Tanımı / Description	Ölçü/Dimension	Miktar/Qty.
1	422044	Merkezi Rulman / Bearing	Ø 72,5x46x15 mm	1
2	426017	Metel Buçuk / Bushing	Ø 44x18x15 mm	1
3	422045	Rulman / Bearing	Ø 52x46x16 mm	1
4	426030	Yüzük / Ring	Ø 44x13 mm	1
5	428033	Pat. Washer	Ø 73x47 mm	1

Tip / Application

LR6 548, 549, 550, 551, 554, 555, 592, 593, 594, 595, 630, 631

MERITOR**424197**

Kaliper Lastik ve Keçe Takimi / Caliper Boot & Seal Kit

LISA series

Orjinal No:

Cross No : 5H841



S.No.	Ekensan No.	Ürün Tanımı / Description	Ölçü/Dimension	Miktar/Qty.
1	421009	Conta / Gasket		1
2	423043	Saç Kapak / Cap		1
3	423044	Dis Mil Sacı Lastiği / Seal		1
4	423045	Plastik Kapak / Plastic Cover		1
5	423046	O-ring / O-Ring		1
6	423047	Tez Lastiği / Dust Cover		1
7	423022	Tez Lastiği / Dust Cover		2
8	423042	Keçe / Seal		1

Tip / Application

LR6 554, 555, 594, 595

MERITOR

424209

LISA series



Kaliper Kilit Mekanizması (Sag) / Caliper Operating Shaft (Right)

Orjinal No:

Cross No : ME 81032MC 81152

S.No.	Ekersan No.	Ürün Tanımı / Description	Ölçü/Dimension	Miktar/Qty.
1	422046	Soft Mil Sag / Operation Shaft (R)		1
2	422047	Soft Mil Kandıgı Sag /		1
3	422050	Sabitleme Pimemil / Antirotation Pin		1
4	422051	Bilye / Ball		3

Tip / Application

LRG 549, 551, 555, 593, 595, 631

MERITOR

424210

LISA series



Kaliper Kilit Mekanizması (Sol) / Caliper Operating Shaft (Left)

Orjinal No:

Cross No : ME 81031MC 81151

S.No.	Ekersan No.	Ürün Tanımı / Description	Ölçü/Dimension	Miktar/Qty.
1	422048	Soft Mil Sol / Operation Shaft (L)		1
2	422049	Soft Mil Kandıgı Sol /		1
3	422050	Sabitleme Pimemil / Antirotation Pin		1
4	422051	Bilye / Ball		3

Tip / Application

LRG 548, 550, 554, 592, 594, 630

MERITOR

424258

LISA series



Kaliper Perno Tamir Takımı / Caliper Pin Repair Kit

Orjinal No: 5001845385

Cross No : 94032

S.No.	Ekersan No.	Ürün Tanımı / Description	Ölçü/Dimension	Miktar/Qty.
1	424050	Kaliper Pernesi / Caliper Bolt	Ø 10x175 mm	1
2	424049	Kaliper Pernesi /	Ø 10x75 mm	1
3	425058	Kaliper Vidası / Caliper Screw	M18x1,5x115 mm	1
4	425059	Kaliper Vidası / Caliper Screw	M18x1,5x95 mm	1
5	426046	Metal Burç / Bushing	Ø 30x31,5x14x26 mm	1
6	426047	Plastik Burç / Plastik Bushing	Ø 30x34x26 mm	2
7	423086	Toz Lastığı / Dust Cover		2
8	428037	Perno Tapası / Bolt Plug	Ø 37x11 mm	1
9	426048	Kaliper Yüzüğü / Caliper Ring	Ø 34x26x31 mm	2

Tip / Application

LISA SERIES

RENAULT

424261

Kaliper Lastik ve Keçe Takımı / Caliper Boot & Seal Kit

LISA series

Orjinal No: 3088113 / 3089320

Cross No : 54478



S.No.	Ekensan No.	Ürün Tanıtımı / Description	Ölçü/Dimension	Miktar/Qty.
1	423009	Conta / Gasket		1
2	423043	Saç Kapak / Cap		1
3	423044	Dis Mil Sacı Lastiği / Seal		1
4	423045	Plastik Kapak / Plastic Cover		1
5	423046	O-ring / O-Ring		1
6	423047	Toz Lastiği / Dust Cover		1
7	423050	Kaliper Toz Lastiği / Caliper Dust Cover		2
8	423022	Toz Lastiği / Dust Cover		2
9	423059	Toz Lastiği / Dust Cover		2

Tip / Application

LRG 548, 549, 550, 551S, 92, 593, 630, 631

424262

Masura Bilya / Roller Bearing

LISA series

Orjinal No:

Cross No :



S.No.	Ekensan No.	Ürün Tanıtımı / Description	Ölçü/Dimension	Miktar/Qty.
1	424262	Masura Bilya / Roller Bearing		1

Tip / Application

LRG 548, 549, 550, 551, 554, 555, 592, 593, 594, 595, 630, 631

424263

Masura Bilya / Roller Bearing

LISA series

Orjinal No:

Cross No :



S.No.	Ekensan No.	Ürün Tanıtımı / Description	Ölçü/Dimension	Miktar/Qty.
1	424263	Masura Bilya / Roller Bearing		1

Tip / Application

LRG 548, 549, 550, 551, 554, 555, 592, 593, 594, 595, 630, 631

424273

Kaliper Tamir Takimi Komple (Sag) / Caliper Repair Kit Full (Right)

LISA series

Original No:

Cross No :



S.No.	Ekersan No.	Ürün Tanıtımı / Description	Ölçü/Dimension	Miktar/Qty.
1	424123	Perno Tamir Takimi / Caliper Pin Repair Kit		1
2	424209	Kaliper Kilit Mekanizması (Sag) / Caliper Operating Shaft (Right)		1
3	424161	Kaliper Ayar Dişlisi(Sag) / Caliper Adjusting Gear (Right)		1
4	424064	Kaliper Ayar Mekanizması(Sag) / Caliper Adjusting Mechanism (Right)		1
5	424090	Kaliper Rulman Takimi / Caliper Roller Bearing Set		1
6	424097	Kaliper Lastik ve Keçe Takımı / Caliper Boot & Seal Kit		1
7	424089	Kaliper Balata Tutucu / Caliper Push Plate		1

Tip / Application

424274

Kaliper Tamir Takimi Komple (Sol) / Caliper Repair Kit Full (Left)

LISA series

Original No:

Cross No :



S.No.	Ekersan No.	Ürün Tanıtımı / Description	Ölçü/Dimension	Miktar/Qty.
1	424123	Perno Tamir Takimi / Caliper Pin Repair Kit		1
2	424210	Kaliper Kilit Mekanizması (Sol) / Caliper Operating Shaft (Left)		1
3	424062	Kaliper Ayar Dişlisi(Sol) / Caliper Adjusting Gear (Left)		1
4	424063	Kaliper Ayar Mekanizması(Sol) / Caliper Adjusting Mechanism (Left)		1
5	424090	Kaliper Rulman Takimi / Caliper Roller Bearing Set		1
6	424097	Kaliper Lastik ve Keçe Takımı / Caliper Boot & Seal Kit		1
7	424089	Kaliper Balata Tutucu / Caliper Push Plate		1

Tip / Application

WABCO

WABCO

422100

Kaliper Toz Lastığı & Perno Takımı / Caliper Boot & Pin Repair Kit

WBC 10", 17.5" series

Orjinal No:

Cross No :



Tip / Application

40 175 058, 059, 070, 071, 072, 073

S.No.	Ekersan No.	Ürün Tanımı / Description	Ölçü/Dimension	Miktar/Qty.
1	422001	Ayar Mekanizması / Adjusting Mechanism	109 mm	1
2	422005	Ayar Çivisi Pimli / Calibration Bolt With Pin	87 mm	1
3	424009	Kaliper Perno / Caliper Bolt	Ø 30x88 mm	1
4	424010	Kaliper Perno / Caliper Bolt	Ø 30x75 mm	1
5	425009	Kaliper Vidası / Caliper Screw	M16x1,5x90 mm	1
6	425005	Kaliper Vidası / Caliper Screw	M16x1,5x70 mm	1
7	423014	Kirik Yeşil / Bellow (Green)		2
8	423013	Toz Lastığı / Dust Cover	Ø 30x34x20 mm	1
9	426004	Metal Burç / Metal Bushing	Ø 34x16 mm	3
10	429006	Perno Tapası / Bolt Plug		2
11	422109	Mekanizma Pul Takımı / Mechanism Washer Kit		1
12	422002	Yay Yüzüğü Kalın / Spring Ring Thick		1
13	422003	Yay Yüzüğü İnce / Spring Ring Thin		1
14	427003	Kuruca Yay / Spring		1

WABCO

422101

Kaliper Toz Lastığı & Perno Takımı / Caliper Boot & Pin Repair Kit

WBC 10", 17.5" series

Orjinal No:

Cross No :



Tip / Application

40 175 058, 059, 070, 071, 072, 073

S.No.	Ekersan No.	Ürün Tanımı / Description	Ölçü/Dimension	Miktar/Qty.
1	422001	Ayar Mekanizması / Adjusting Mechanism	109 mm	1
2	422006	Ayar Çivisi Yarıklı / Calibration Bolt With Groove	87 mm	1
3	424009	Kaliper Perno / Caliper Bolt	Ø 30x88 mm	1
4	424010	Kaliper Perno / Caliper Bolt	Ø 30x75 mm	1
5	425009	Kaliper Vidası / Caliper Screw	M16x1,5x90 mm	1
6	425005	Kaliper Vidası / Caliper Screw	M16x1,5x70 mm	1
7	423014	Kirik Yeşil / Bellow (Green)		2
8	423013	Toz Lastığı / Dust Cover		1
9	426004	Metal Burç / Metal Bushing	Ø 30x34x20 mm	3
10	429006	Perno Tapası / Bolt Plug	Ø 34x16 mm	2
11	422109	Mekanizma Pul Takımı / Mechanism Washer Kit		1
12	422002	Yay Yüzüğü Kalın / Spring Ring Thick		1
13	422003	Yay Yüzüğü İnce / Spring Ring Thin		1
14	427003	Kuruca Yay / Spring		1

WABCO

422102

Kaliper Toz Lastığı & Perno Takımı / Caliper Boot & Pin Repair Kit

WBC 10", 17.5" series

Orjinal No:

Cross No :



Tip / Application

40 175 058, 059, 070, 071, 072, 073

S.No.	Ekersan No.	Ürün Tanımı / Description	Ölçü/Dimension	Miktar/Qty.
1	422001	Ayar Mekanizması / Adjusting Mechanism	109 mm	1
2	422005	Ayar Çivisi Pimli / Caliper Calibration Bolt With Pin (87 mm)	87 mm	1
3	424009	Kaliper Perno / Caliper Bolt	Ø 30x88 mm	1
4	424010	Kaliper Perno / Caliper Bolt	Ø 30x75 mm	1
5	425009	Kaliper Vidası / Caliper Screw	M16x1,5x90 mm	1
6	425005	Kaliper Vidası / Caliper Screw	M16x1,5x70 mm	1
7	423014	Kirik Yeşil / Bellow (Green)		2
8	423013	Toz Lastığı / Dust Cover		1
9	426004	Metal Burç / Metal Bushing	Ø 30x34x20 mm	3
10	429006	Perno Tapası / Bolt Plug	Ø 34x16 mm	2
11	422002	Yay Yüzüğü Kalın / Spring Ring Thick		1

422103

Perno Tamir Takimi / Caliper Boot & Pin Repair Kit

WBC 10", 17.5" series

Original No: 1428853 / 4228857

Cross No : 1299689/1299782



S.No.	Ekersan No.	Ürün Tanıtım / Description	Ölçü/Dimension	Miktar/Qty.
1	424009	Kaliper Perno / Caliper Bolt	Ø 30x88 mm	1
2	424010	Kaliper Perno / Caliper Bolt	Ø 30x75 mm	1
3	429009	Kaliper Vidası / Caliper Screw	M16x,5x70 mm	1
4	425005	Kaliper Vidası / Caliper Screw	M16x,5x70 mm	1
5	423014	Kırık Yastık / Bellow (Green)		2
6	423013	Toz Lastığı / Dust Cover		1
7	426004	Metal Barç / Metal Bushing	Ø 30x34x20 mm	3
8	429006	Perno Tapası / Bolt Plug		2
9	423015	Tapası / Plug		1

Tip / Application

40 175 058, 059, 070, 071, 072, 073

422104

Kaliper Toz Lastığı & Perno Takimi / Caliper Boot & Pin Repair Kit

WBC 10", 17.5" series

Original No:

Cross No :



S.No.	Ekersan No.	Ürün Tanıtım / Description	Ölçü/Dimension	Miktar/Qty.
1	424009	Kaliper Perno / Caliper Bolt	Ø 30x88 mm	1
2	424010	Kaliper Perno / Caliper Bolt	Ø 30x75 mm	1
3	423014	Kırık Yastık / Bellow (Green)		2
4	423013	Toz Lastığı / Dust Cover		1
5	426004	Metal Barç / Metal Bushing	Ø 30x34x20 mm	3
6	429006	Perno Tapası / Bolt Plug	Ø 34x16 mm	2

Tip / Application

40 175 058, 059, 070, 071, 072, 073

422105

Kaliper Toz Lastığı Takimi / Caliper Boot Repair Kit

WBC 10", 17.5" series

Original No:

Cross No :



S.No.	Ekersan No.	Ürün Tanıtım / Description	Ölçü/Dimension	Miktar/Qty.
1	423013	Toz Lastığı / Dust Cover		1
2	423014	Kırık Yastık / Bellow (Green)		2

Tip / Application

40 175 058, 059, 070, 071, 072, 073

WABCO

422110

WBC 10", 17.5" series



Tip / Application

40 175 058, 059, 070, 071, 072, 073

Kaliper Toz Lastığı & Perno Takımı / Caliper Boot & Pin Repair Kit

Orjinal No:

Cross No :

S.No.	Ekersan No.	Ürün Tanıtımı / Description	Ölçü/Dimension	Miktar/Qty.
1	422001	Ayar Mekanizması / Adjusting Mechanism	109 mm	1
2	422006	Ayar Ovakası Yarımları / Caliper Calibration Bolt With Groove (87 mm)	87 mm	1
3	424009	Kaliper Perno / Caliper Bolt	Ø 36x88 mm	1
4	424000	Kaliper Perno / Caliper Bolt	Ø 36x73 mm	1
5	425009	Kaliper Vidası / Caliper Screw	M16x1,5x90 mm	1
6	425005	Kaliper Vidası / Caliper Screw	M16x1,5x70 mm	1
7	423004	Körük Yeşil / Bellow (Green)		1
8	429006	Perno Tapası / Bolt Mug	Ø 34x16 mm	2
9	426004	Metal Burç / Metal Bushing	Ø 38x14x20 mm	3
10	429006	Perno Tapası / Bolt Mug	Ø 34x16 mm	2
11	422002	Yay Yüzüğü Kalın / Spring Ring Thick		1

WABCO

422117

WBC 10", 17.5" series



Tip / Application

40 175 062, 063, 064, 065

Kaliper Toz Lastığı & Perno Takımı / Caliper Boot & Pin Repair Kit

Orjinal No: 252002 / 502102000

Cross No : 1399084

S.No.	Ekersan No.	Ürün Tanıtımı / Description	Ölçü/Dimension	Miktar/Qty.
1	425009	Kaliper Vidası / Caliper Screw	M16x1,5x90 mm	1
2	425005	Kaliper Vidası / Caliper Screw	M16x1,5x70 mm	1
3	423004	Körük Yeşil / Bellow (Green)		2
4	423003	Toz Lastığı / Dust Cover		1
5	426004	Metal Burç / Metal Bushing	Ø 38x14x20 mm	3
6	429006	Perno Tapası / Bolt Mug	Ø 34x16 mm	2

DAF / RENAULT

WABCO

422118

WBC 10", 17.5" series



Tip / Application

40 175 025, 026, 027, 028, 049, 050, 051, 052, 080, 081

Kaliper Toz Lastığı & Perno Takımı / Caliper Boot & Pin Repair Kit

Orjinal No: 0200220000 / 2517407

Cross No : 1399580

S.No.	Ekersan No.	Ürün Tanıtımı / Description	Ölçü/Dimension	Miktar/Qty.
1	425009	Kaliper Vidası / Caliper Screw	M16x1,5x90 mm	1
2	425005	Kaliper Vidası / Caliper Screw	M16x1,5x70 mm	1
3	423004	Körük Yeşil / Bellow (Green)		2
4	423003	Toz Lastığı / Dust Cover		1
5	426004	Metal Burç / Metal Bushing	Ø 38x14x20 mm	3
6	429006	Perno Tapası / Bolt Mug	Ø 34x16 mm	2
7	421001	Kapak Çantası / Cover Bagset		1
8	423006	Kapak Kaçını / Sealing Ring		1
9	423015	Tapa / Plug		1
10	425008	Vida / Screw		0

MAN / DAF

Kaliper Perno Tamir Takımı / Caliper Pin Repair Kit

WBC 10", 17.5" series

Orjinal No : 8150800623 / 883139300 / 3305568 / 3517594

Cross No : 02999729

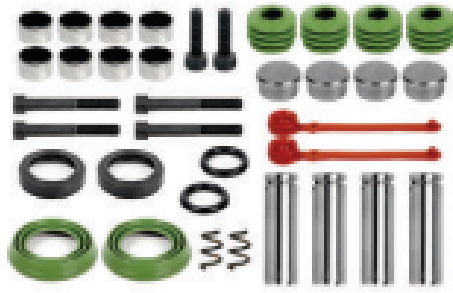

S.No.	Eksan No.	Ürün Tanımı / Description	Ölçü/Dimension	Miktar/Qty.
1	424044	Kaliper Pernesi / Caliper Bolt	Ø 24,6x81 mm	2
2	424045	Kaliper Pernesi / Caliper Bolt	Ø 25x81 mm	2
3	425045	Kaliper Vidası / Caliper Screw	M12x1,5x90 mm	4
4	423066	Toz Lastiği / Dust Cover		2
5	423067	Körük Yeşil / Bellow (Green)		4
6	426042	Metal Burç / Bushing	Ø 25x28x15 mm	8
7	428060	Kaliper Keçesi / Caliper Seal		2
8	423089	O-ring / O-Ring		2
9	429024	Perno Tapası / Bolt Plug	Ø 28x16 mm	4
10	425046	Kaliper Vidası / Caliper Screw	M6x1x20 mm	2
11	427025	Yay / Spring		2
12	423068	Lastik Tapa / Rubber Plug		2

Tip / Application

10" SERIES

WABCO

422005

Ayar Civatası Pimli / Caliper Calibration Bolt With Pin (87 mm)

WBC 17.5" series

Original No:

Cross No :



S.No.	Ekansan No.	Ürün Tanıtımı / Description	Ölçü/Dimension	Miktar/Qty.
1	422005	Ayar Civatası Pimli / Caliper Calibration Bolt With Pin (87 mm)	87 mm	1

Tip / Application

ALL 17.5" WABCO CALIPERS

WABCO

422006

Ayar Civatası Yarıklı / Caliper Calibration Bolt With Groove (87 mm)

WBC 17.5" series

Original No:

Cross No :



S.No.	Ekansan No.	Ürün Tanıtımı / Description	Ölçü/Dimension	Miktar/Qty.
1	422006	Ayar Civatası Yarıklı / Caliper Calibration Bolt With Groove (87 mm)	87 mm	1

Tip / Application

ALL 17.5" WABCO CALIPERS

WABCO

422106

Kaliper Ayar Mekanizma Seti / Caliper Adjustment Mechanism Kit

WBC 17.5" series

Original No:

Cross No :



S.No.	Ekansan No.	Ürün Tanıtımı / Description	Ölçü/Dimension	Miktar/Qty.
1	422001	Ayar Mekanizması / Adjusting Mechanism	109 mm	1
2	422005	Ayar Civatası Pimli / Caliper Calibration Bolt With Pin (87 mm)	87 mm	1
3	428000	Sakman / Cirdip		1
4	428011	Tubucu Ayar Pulu / Adjusting Washer		1
5	422002	Yay Yüzüğü Kalın / Spring Ring Thick		1
6	422003	Yay Yüzüğü İnce / Spring Ring Thin		1
7	427003	Kuruca Yay / Spring		1

Tip / Application

ALL 17.5" WABCO CALIPERS

WABCO

422107

Kaliper Ayar Mekanizma Seti / Caliper Adjustment Mechanism Kit

WBC 17.5" series

Orjinal No:

Cross No :



S.No.	Ekansan No.	Ürün Tanımı / Description	Ölçü/Dimension	Miktar/Qty.
1	422001	Ayar Mekanizması / Adjusting Mechanism	109 mm	1
2	422004	Ayar Çivili Yarımlı / Calibration Bolt With Groove	87 mm	1
3	427004	Yay / Spring		1
4	428007	Pul / Washer	Ø 35,2x49,5x1 mm	1
5	428008	Pul / Washer	Ø 31,9x45,2x1,7 mm	1
6	428009	Pul / Washer	14,5x41,5x1,5 mm	1
7	428010	Sekman / Circlip		1
8	428011	Tutucu Ayar Pulu / Adjusting Washer		1
9	422002	Yay Yüzüğü Kalın / Spring Ring Thick		1
10	422003	Yay Yüzüğü İnce / Spring Ring Thin		1

Tip / Application

ALL 17.5" WABCO CALIPERS

WABCO

422108

Mekanizma Seti / Caliper Adjustment Mechanism Kit

WBC 17.5" series

Orjinal No:

Cross No :



S.No.	Ekansan No.	Ürün Tanımı / Description	Ölçü/Dimension	Miktar/Qty.
1	422001	Ayar Mekanizması / Adjusting Mechanism	109 mm	1
2	422005	Ayar Çivili Pimli / Caliper Calibration Bolt With Pin (87 mm)	87 mm	1
3	422002	Yay Yüzüğü Kalın / Spring Ring Thick		1
4	422003	Yay Yüzüğü İnce / Spring Ring Thin		1
5	427003	Kurucu Yay / Spring		1

Tip / Application

ALL 17.5" WABCO CALIPERS

WABCO

422109

Kaliper Ayar Mekanizma Pul Takımı / Caliper Adjusting Mechanism Washer Kit

WBC 17.5" series

Orjinal No:

Cross No :



S.No.	Ekansan No.	Ürün Tanımı / Description	Ölçü/Dimension	Miktar/Qty.
1	428007	Pul / Washer	Ø 35,2x49,5x1 mm	1
2	428008	Pul / Washer	Ø 31,9x45,2x1,7 mm	1
3	428010	Sekman / Circlip		1
4	428011	Tutucu Ayar Pulu / Adjusting Washer		1
5	428009	Pul / Washer		1
6	427004	Yay / Spring		1

Tip / Application

ALL 17.5" WABCO CALIPERS

WABCO

422114

Mekanizma Seti / Caliper Adjustment Mechanism Kit

WBC 17.5" series

Orjinal No:
Cross No :



S.No.	Ekersan No.	Ürün Tanıtımı / Description	Ölçü/Dimension	Miktar/Qty.
1	422001	Ayar Mekanizması / Adjusting Mechanism	109 mm	1
2	422006	Ayar Ovalası Yarımları / Caliper Calibration Bolt With Groove (87 mm)	87 mm	1

Tip / Application

ALL 17.5" WABCO CALIPERS

WABCO

422115_2

Kaliper Masura Bilya Yatağı / Caliper Lever

WBC 17.5" series

Orjinal No:
Cross No :



S.No.	Ekersan No.	Ürün Tanıtımı / Description	Ölçü/Dimension	Miktar/Qty.
1	422115	Masura Bilya Yatağı / Caliper Lever		1

Tip / Application

ALL 17.5", 19.5" AND 22.5" (SINGLE PISTON) WABCO CALIPERS

WABCO

422116

Kaliper Ayar Mekanizma Yatagi / Caliper Adjusting Mechanism Housing

WBC 17.5" series

Orjinal No:
Cross No :



S.No.	Ekersan No.	Ürün Tanıtımı / Description	Ölçü/Dimension	Miktar/Qty.
1	422008	Mekanizma Seti Mechanism Kit	109 mm - 87 mm	1
2	422116	Mekanizma Yatagi Mechanism Housing	33 mm	1
3	422109	Mekanizma Pul Takımı Mechanism Washer Kit		1

Tip / Application

ALL 17.5", 19.5" AND 22.5" (SINGLE PISTON) WABCO CALIPERS

WABCO

422119

Kaliper Kapak Conta Takımı / Cover Plate Gasket Kit

WBC 17.5" series

Orjinal No:

Cross No :



S.No.	Ekersan No.	Ürün Tanıtımı / Description	Ölçü/Dimension	Miktar/Qty.
1	423036	Kapak Keçisi / Sealing Ring		1
2	423001	Kapak Contası / Cover Gasket		1
3	423015	Tapa Plug		1

Tip / Application

ALL 17,5", 19,5" AND 22,5" (SINGLE PISTON) WABCO CALIPERS

WABCO

422120

Balata Tutucusu Sol / Caliper Lining Plate With Pin (Left)

WBC 17.5" series

Orjinal No:

Cross No :



S.No.	Ekersan No.	Ürün Tanıtımı / Description	Ölçü/Dimension	Miktar/Qty.
1	422120	Balata Tutucusu Sol / Caliper Lining Plate With Pin (Left)		1

Tip / Application

ALL 17.5" WABCO CALIPERS

WABCO

422121

Balata Tutucusu Sağ / Caliper Lining Plate With Pin (Right)

WBC 17.5" series

Orjinal No:

Cross No :



S.No.	Ekersan No.	Ürün Tanıtımı / Description	Ölçü/Dimension	Miktar/Qty.
1	422121	Balata Tutucusu Sağ / Caliper Lining Plate With Pin (Right)		1

Tip / Application

ALL 17.5" WABCO CALIPERS

WABCO

422122

Balata Tutucusu Sol / Caliper Lining Plate With Groove (Left)

WBC 17.5" series

Orjinal No:

Cross No :



S.No.	Ekersan No.	Ürün Tanıtımı / Description	Ölçü/Dimension	Miktar/Qty.
1	422122	Balata Tutucusu Sol / Caliper Lining Plate With Groove (Left)		1

Tip / Application

ALL 17.5" WABCO CALIPERS

WABCO

422123

Balata Tutucusu Sag / Caliper Lining Plate With Groove (Right)

WBC 17.5" series

Orjinal No:

Cross No :



S.No.	Ekersan No.	Ürün Tanıtımı / Description	Ölçü/Dimension	Miktar/Qty.
1	422123	Balata Tutucusu Sag / Caliper Lining Plate With Groove (Right)		1

Tip / Application

ALL 17.5" WABCO CALIPERS

WABCO

422124

Kaliper Masura Bilya Takımı / Caliper Roller Bearing Kit

WBC 17.5" series

Orjinal No:

Cross No :



S.No.	Ekersan No.	Ürün Tanıtımı / Description	Ölçü/Dimension	Miktar/Qty.
1	423701	Kaliper Masura Bilya / Caliper Roller Bearing		2

Tip / Application

ALL WABCO TYPE CALIPERS

WABCO

422151

Ayar Mekanizması / Caliper Adjustment Mechanism Kit (109 mm)

WBC 17.5" series

Orjinal No:

Cross No :



S.No.	Ekersan No.	Ürün Tanıtımı / Description	Ölçü/Dimension	Miktar/Qty.
1	422151	Ayar Mekanizması / Caliper Adjustment Mechanism Kit (109 mm)	109 mm	1
2	428010	Sekman / Circle		1
3	428011	Tücu Ayar Pulu / Adjusting Washer		1
4	422003	Yay Yüzüğü İnce / Spring Ring Thin		1
5	427003	Kurucu Yay / Spring		1
6	428007	Pul Washer	Ø 35,2x49,3x1 mm	1
7	428008	Pul Washer	Ø 31,9x45,2x0,7 mm	1
8	428009	Pul Washer	Ø 14,3x41,5x1,5 mm	1
9	427004	Yay Spring		1
10	427003	Yay Yüzüğü Kalın Spring Ring Thick		1

Tip / Application

ALL 17.5" WABCO CALIPERS

WABCO

422152

Kaliper Ayar Mekanizma Seti / Caliper Adjusting Mechanism Set

WBC 17.5" series

Orjinal No:

Cross No :



S.No.	Ekersan No.	Ürün Tanıtımı / Description	Ölçü/Dimension	Miktar/Qty.
1	422108	Mekanizma Seti / Caliper Adjustment Mechanism Kit	109 mm - 87 mm	1
2	422116	Kaliper Ayar Mekanizma Yatagi / Caliper Adjusting Mechanism Housing	33 mm	1
3	422109	Mekanizma Pul Takımı Mechanism Washer Kit		1

Tip / Application

ALL 17.5" WABCO CALIPERS

WABCO

422153

Kaliper Ayar Mekanizma Seti / Caliper Adjusting Mechanism Set

WBC 17.5" series

Orjinal No:

Cross No :



S.No.	Ekersan No.	Ürün Tanıtımı / Description	Ölçü/Dimension	Miktar/Qty.
1	422114	Mekanizma Seti / Caliper Adjustment Mechanism Kit	109 mm - 87 mm	1
2	422116	Kaliper Ayar Mekanizma Yatagi / Caliper Adjusting Mechanism Housing	33 mm	1

Tip / Application

ALL 17.5" WABCO CALIPERS

WABCO

422154

Kaliper Balata Tutucu Tamir Takimi / Caliper Pad Retainer Repair Kit

WBC 17.5" series

Orjinal No:

Cross No :

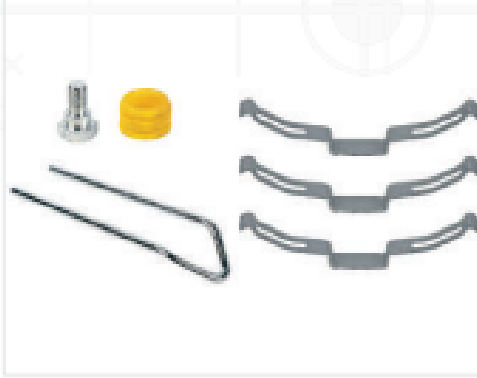

S.No.	Ekarsan No.	Ürün Tanıtımı / Description	Ölçü/Dimension	Miktar/Qty.
1	428077	Kaliper Tutucu / Brake Pad Retainer		1
2	429034	Balata Taahhüt Sac /		3
3	425055	Wala Screw		1
4	423015	Tapa Plug		1

Tip / Application

ALL 17.5" WABCO CALİPERS

WABCO

422155

Perno Tapa Seti / Bolt Plug Kit

WBC 17.5" series

Orjinal No:

Cross No :



S.No.	Ekarsan No.	Ürün Tanıtımı / Description	Ölçü/Dimension	Miktar/Qty.
1	429021	Perno Tapası / Bolt Plug	Ø 14,5x18,5 mm	5

Tip / Application

ALL 17.5" WABCO CALİPERS

WABCO

422156

Kaliper Keçe Takimi / Caliper Seal Kit

WBC 17.5" series

Orjinal No:

Cross No :

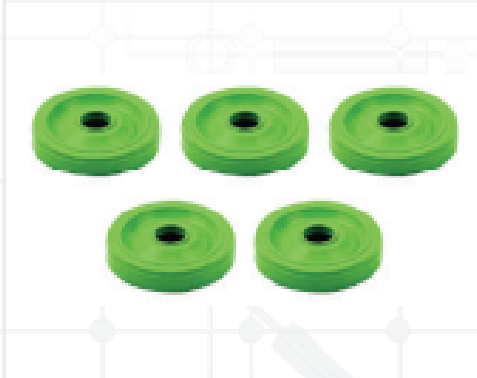

S.No.	Ekarsan No.	Ürün Tanıtımı / Description	Ölçü/Dimension	Miktar/Qty.
1	428075	Kaliper Keçesi / Caliper Seal		5

Tip / Application

ALL 17.5" WABCO CALİPERS

422007

Ayar Civatası Pimli / Caliper Calibration Bolt With Pin (91 mm)

WBC 19.5" - 22.5" (Single Piston) series

Original No:

Cross No :



S.No.	Ekansan No.	Ürün Tanıtımı / Description	Ölçü/Dimension	Miktar/Qty.
1	422007	Ayar Civatası Pimli / Caliper Calibration Bolt With Pin (91 mm)	91 mm	1

Tip / Application

ALL 19,5" AND 22,5" (SINGLE PISTON) WABCO CALIPERS

422109

Kaliper Ayar Mekanizma Pul Takımı / Caliper Adjusting Mechanism Washer Kit

WBC 19.5" - 22.5" (Single Piston) series

Original No:

Cross No :



S.No.	Ekansan No.	Ürün Tanıtımı / Description	Ölçü/Dimension	Miktar/Qty.
1	427004	Yay Spring		1
2	428007	Pul Washer	Ø 35,2x49,5x1 mm	1
3	428008	Pul Washer	Ø 31,9x45,2x0,7 mm	1
4	428009	Pul Washer	Ø 14,3x41,5x1,5 mm	1
5	428010	Sekman / Clip		1
6	428011	Tutucu Ayar Pulu / Adjusting Washer		1

Tip / Application

ALL 19,5" AND 22,5" (SINGLE PISTON) WABCO CALIPERS

422111

Kaliper Ayar Mekanizma Seti / Caliper Adjustment Mechanism Kit

WBC 19.5" - 22.5" (Single Piston) series

Original No:

Cross No :



S.No.	Ekansan No.	Ürün Tanıtımı / Description	Ölçü/Dimension	Miktar/Qty.
1	422009	Ayar Mekanizması / Adjusting Mechanism	114 mm	1
2	422007	Ayar Civatası Pimli / Caliper Calibration Bolt With Pin (91 mm)	91 mm	1
3	428010	Sekman / Clip		1
4	422002	Yay Yüzüğü Kalın / Spring Ring Thick		1
5	422003	Yay Yüzüğü İnce / Spring Ring Thin		1
6	428007	Pul Washer	Ø 35,2x49,5x1 mm	1
7	428008	Pul Washer	Ø 31,9x45,2x0,7 mm	1
8	428009	Pul Washer	Ø 14,3x41,5x1,5 mm	1
9	427004	Yay Spring		1
10	428011	Tutucu Ayar Pulu / Adjusting Washer		1
11	427003	Karucu Yay / Spring		1

Tip / Application

ALL 19,5" AND 22,5" (SINGLE PISTON) WABCO CALIPERS

WABCO

422112

Mekanizma Seti / Caliper Adjustment Mechanism Kit

WBC 19.5" - 22.5" (Single Piston) series

Orjinal No:

Cross No :

S.No.	Ekersan No.	Ürün Tanıtımı / Description	Ölçü/Dimension	Miktar/Qty.
1	422009	Ayar Mekanizması / Adjusting Mechanism	114 mm	1
2	422007	Ayar Ovatası Pimli / Caliper Calibration Bolt With Pin (91 mm)	91 mm	1
3	422002	Yay Yüzüğü Kalın / Spring Ring Thick		1
4	422003	Yay Yüzüğü İnce / Spring Ring Thin		1
5	427003	Kurucu Yay / Spring		1



Tip / Application

ALL 19,5" AND 22,5" (SINGLE PISTON) WABCO CALIPERS

WABCO

422115

Kaliper Masura Bilya Yatağı / Caliper Lever

WBC 19.5" - 22.5" (Single Piston) series

Orjinal No:

Cross No :

S.No.	Ekersan No.	Ürün Tanıtımı / Description	Ölçü/Dimension	Miktar/Qty.
1	422115	Masura Bilya Yatağı / Caliper Lever		1



Tip / Application

ALL 17,5", 19,5" AND 22,5" (SINGLE PISTON) WABCO CALIPERS

WABCO

422119

Kaliper Kapak Conta Takımı / Cover Plate Gasket Kit

WBC 19.5" - 22.5" (Single Piston) series

Orjinal No:

Cross No :

S.No.	Ekersan No.	Ürün Tanıtımı / Description	Ölçü/Dimension	Miktar/Qty.
1	423006	Kapak Keçesi / Sealing Ring		1
2	421001	Kapak Contası / Cover Gasket		1
3	422015	Plug / Plug		1



Tip / Application

ALL 17,5", 19,5" AND 22,5" (SINGLE PISTON) WABCO CALIPERS

WABCO

422124

Kaliper Masura Bilya Takımı / Caliper Roller Bearing Kit

WBC 19.5" - 22.5" (Single Piston) series

Orjinal No:

Cross No :



S.No.	Ekarsan No.	Ürün Tanıtımı / Description	Ölçü/Dimension	Miktar/Qty.
1	423701	Kaliper Masura Bilya / Caliper Roller Bearing		2

Tip / Application

ALL WABCO TYPE CALIPERS

WABCO

422125

Balata Tutucusu Sağ / Caliper Lining Plate With Groove (Right)

WBC 19.5" - 22.5" (Single Piston) series

Orjinal No:

Cross No :



S.No.	Ekarsan No.	Ürün Tanıtımı / Description	Ölçü/Dimension	Miktar/Qty.
1	422125	Balata Tutucusu Sağ / Caliper Lining Plate With Groove (Right)		1

Tip / Application

ALL 19,5" WABCO CALIPERS

WABCO

422126

Balata Tutucusu Sol / Caliper Lining Plate With Groove (Left)

WBC 19.5" - 22.5" (Single Piston) series

Orjinal No:

Cross No :



S.No.	Ekarsan No.	Ürün Tanıtımı / Description	Ölçü/Dimension	Miktar/Qty.
1	422126	Balata Tutucusu Sol / Caliper Lining Plate With Groove (Left)		1

Tip / Application

ALL 19,5" WABCO CALIPERS

422127

WBC 19.5" - 22.5" (Single Piston) series



Tip / Application

Kaliper Toz Lastığı & Perno Takımı / Caliper Boot & Pin Repair Kit

Orjinal No:

Cross No :

S.No.	Ekersan No.	Ürün Tanıtımı / Description	Ölçü/Dimension	Miktar/Qty.
1	422009	Ayar Mekanizması / Adjusting Mechanism	114 mm	1
2	422007	Ayar Çivisi Pimli / Calibration Bolt With Pin	91 mm	1
3	424011	Kaliper Perno / Caliper Bolt	Ø 38x120 mm	1
4	424012	Kaliper Perno / Caliper Bolt	Ø 38x76 mm	1
5	425010	Kaliper Vidası / Caliper Screw	M16x1,5x120 mm	1
6	425004	Kaliper Vidası / Caliper Screw	M16x1,5x80 mm	1
7	423017	Toz Lastığı Yeşil / Dust Cover		1
8	423018	Körük Yeşil / Bellow (Green)	Ø 44x38x1,3 mm	2
9	428012	Pul Washer	Ø 42x38x30 mm	2
10	426007	Metal Burç / Bushing	Ø 42x29 mm	3
11	429007	Perno Tapası / Bolt Plug	Ø 42x17 mm	1
12	429008	Perno Tapası / Bolt Plug		1
13	422002	Yay Yüzüğü Kalın / Spring Ring Thick		1
14	422003	Yay Yüzüğü İnce / Spring Ring Thin		1
15	427003	Kuruca Yay / Spring		1
16	422109	Mekanizma Pul Takımı / Mechanism Washer Kit		1

422128

WBC 19.5" - 22.5" (Single Piston) series



Tip / Application

Kaliper Toz Lastığı & Perno Takımı / Caliper Boot & Pin Repair Kit

Orjinal No:

Cross No :

S.No.	Ekersan No.	Ürün Tanıtımı / Description	Ölçü/Dimension	Miktar/Qty.
1	422009	Ayar Mekanizması / Adjusting Mechanism	114 mm	1
2	422007	Ayar Çivisi Pimli / Calibration Bolt With Pin	91 mm	1
3	424011	Kaliper Perno / Caliper Bolt	Ø 38x120 mm	1
4	424012	Kaliper Perno / Caliper Bolt	Ø 38x76 mm	1
5	425010	Kaliper Vidası / Caliper Screw	M16x1,5x120 mm	1
6	425004	Kaliper Vidası / Caliper Screw	M16x1,5x80 mm	1
7	423017	Toz Lastığı Yeşil / Dust Cover		1
8	423018	Körük Yeşil / Bellow (Green)	Ø 44x38x1,3 mm	2
9	428012	Pul Washer	Ø 42x38x30 mm	2
10	426007	Metal Burç / Bushing	Ø 42x29 mm	3
11	429007	Perno Tapası / Bolt Plug	Ø 42x17 mm	1
12	429008	Perno Tapası / Bolt Plug		1
13	422002	Yay Yüzüğü Kalın / Spring Ring Thick		1
14	422003	Yay Yüzüğü İnce / Spring Ring Thin		1
15	427003	Kuruca Yay / Spring		1

422129

WBC 19.5" - 22.5" (Single Piston) series



Tip / Application

Perno Tamir Takımı / Caliper Boot & Pin Repair Kit

Orjinal No: 3028355

Cross No : 12990736

S.No.	Ekersan No.	Ürün Tanıtımı / Description	Ölçü/Dimension	Miktar/Qty.
1	424011	Kaliper Perno / Caliper Bolt	Ø 38x120 mm	1
2	424012	Kaliper Perno / Caliper Bolt	Ø 38x76 mm	1
3	425003	Kaliper Vidası / Caliper Screw	M16x1,5x120 mm	1
4	425004	Kaliper Vidası / Caliper Screw	M16x1,5x80 mm	1
5	423017	Toz Lastığı Yeşil / Dust Cover Green		1
6	423018	Körük Yeşil / Bellow (Green)		2
7	429007	Perno Tapası / Bolt Plug	Ø 42x17 mm	1
8	429008	Perno Tapası / Bolt Plug	Ø 42x17 mm	1
9	428012	Pul Washer	Ø 42x38x30 mm	2
10	426007	Metal Burç / Bushing		3

WABCO

422130

Kaliper Toz Lastığı & Perno Takimi / Caliper Boot & Pin Repair Kit

WBC 19.5" - 22.5" (Single Piston) series

Orjinal No:

Cross No :



Ø 38 x 76 mm

Ø 38 x 120 mm

S.No.	Ekersan No.	Ürün Tanıtımı / Description	Ölçü/Dimension	Miktar/Qty.
1	424011	Kaliper Pernosu / Caliper Bolt	Ø 38x120 mm	1
2	424012	Kaliper Pernosu / Caliper Bolt	Ø 38x76 mm	1
3	423017	Toz Lastığı Yeşil / Dust Cover Green		1
4	423018	Körük Yeşil / Bellow (Green)		2
5	426007	Metal Barç / Bushing	Ø 42x58x30 mm	3
6	429007	Perno Tapası / Bolt Plug	Ø 42x29 mm	1
7	428012	Pat. Washer		2
8	429008	Perno Tapası / Bolt Plug		1

Tip / Application

WABCO

422131

Kaliper Mekanizma Yatığı / Caliper Adjusting Mechanism Housing

WBC 19.5" - 22.5" (Single Piston) series

Orjinal No:

Cross No :



S.No.	Ekersan No.	Ürün Tanıtımı / Description	Ölçü/Dimension	Miktar/Qty.
1	422030	Kaliper Bilye Yatığı / Bearing Support	38 mm	1
2	427005	Yay Spring		2

Tip / Application

19.5" - 22.5" (SINGLE PISTON) SERIES

WABCO

422132

Balata Tutucusu Sağ / Caliper Lining Plate With Groove (Right)

WBC 19.5" - 22.5" (Single Piston) series

Orjinal No:

Cross No :



S.No.	Ekersan No.	Ürün Tanıtımı / Description	Ölçü/Dimension	Miktar/Qty.
1	422132	Balata Tutucusu Sağ / Caliper Lining Plate With Groove (Right)		1

Tip / Application

ALL 22.5" (SINGLE PISTON) WABCO CALIPERS

422133

WBC 19.5" - 22.5" (Single Piston) series



Tip / Application

ALL 22,5" (SINGLE PISTON) WABCO CALIPERS

Balata Tutucusu Sol / Caliper Lining Plate With Groove (Left)

Orjinal No:

Cross No :

S.No.	Ekersan No.	Ürün Tanıtımı / Description	Ölçü/Dimension	Miktar/Qty.
1	422133	Balata Tutucusu Sol / Caliper Lining Plate With Groove (Left)		1

422134

WBC 19.5" - 22.5" (Single Piston) series



Tip / Application

Kaliper Toz Lastığı & Perno Takımı / Caliper Boot & Pin Repair Kit

Orjinal No: 3434382701 / 1505890

Cross No : 12999738

S.No.	Ekersan No.	Ürün Tanıtımı / Description	Ölçü/Dimension	Miktar/Qty.
1	424011	Kaliper Peması / Caliper Bolt	Ø 38x120 mm	1
2	424012	Kaliper Peması / Caliper Bolt	Ø 38x76 mm	1
3	425090	Kaliper Vidası / Caliper Screw	M16x1,5x120 mm	1
4	425094	Kaliper Vidası / Caliper Screw	M16x1,5x80 mm	1
5	423017	Toz Lastığı Yeşil / Dust Cover Green		1
6	423098	Körük Yeşil / Bellow (Green)		2
7	423099	Körük Beyaz / Bellow (White)		2
8	426012	Plâ / Washer	Ø 42xØx1,3 mm	4
9	426007	Metal Buçuk / Bushing	Ø 42xØxØ mm	3
10	429007	Perno Tapası / Bolt Plug	Ø 42x29 mm	2
11	429008	Perno Tapası / Bolt Plug	Ø 42x17 mm	2

422135

WBC 19.5" - 22.5" (Single Piston) series



Tip / Application

Kaliper Toz Lastığı Takımı / Caliper Boot Repair Kit

Orjinal No:

Cross No :

S.No.	Ekersan No.	Ürün Tanıtımı / Description	Ölçü/Dimension	Miktar/Qty.
1	423017	Toz Lastığı Yeşil / Dust Cover Green		1
2	423098	Körük Yeşil / Bellow (Green)		2
3	423099	Körük Beyaz / Bellow (White)		2
4	426007	Metal Buçuk / Bushing	Ø 42xØxØ mm	3
5	429007	Perno Tapası / Bolt Plug	Ø 42x29 mm	2
6	429008	Perno Tapası / Bolt Plug	Ø 42x17 mm	2
7	426012	Plâ / Washer	Ø 42xØx1,3 mm	4

WABCO

422158

Kaliper Ayar Mekanizma Seti (Pimli - Uzun) / Caliper Adjusting Mechanism Set With Pin

WBC 19.5" - 22.5" (Single Piston) series



Original No:

Cross No :

S.No.	Ekersan No.	Ürün Tanıtımı / Description	Ölçü/Dimension	Miktar/Qty.
1	422112	Mekanizma Seti / Caliper Adjustment Mechanism Kit	114 mm - 91 mm	1
2	422131	Kaliper Mekanizma Yatagi / Caliper Adjusting Mechanism Housing	38 mm	1
3	422109	Kaliper Ayar Mekanizma Pim Takimi / Caliper Adjusting Mechanism Washer Kit		1

Tip / Application

ALL 19.5" AND 22.5" (SINGLE PISTON) WABCO CALIPERS

WABCO

422161

Kaliper Balata Tutucu Tamir Takimi / Caliper Pad Retainer Repair Kit

WBC 19.5" - 22.5" (Single Piston) series

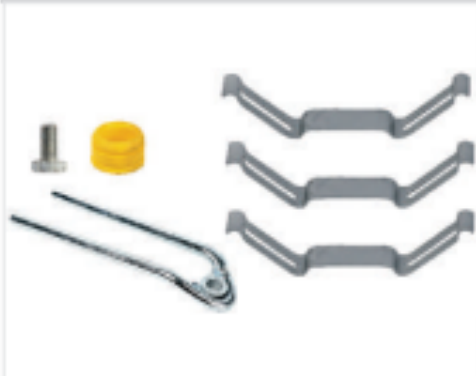

Original No:

Cross No :

S.No.	Ekersan No.	Ürün Tanıtımı / Description	Ölçü/Dimension	Miktar/Qty.
1	428076	Kaliper Tutucu / Brake Pad Retainer		1
2	429032	Balata Tasiyici Sac / Shoe Retainer		3
3	425054	Vida / Screw		1
4	423015	Tapa / Plug		1

Tip / Application

19.5" - 22.5" (SINGLE PISTON) SERIES

WABCO

422162

Kaliper Balata Tutucu Tamir Takimi / Caliper Pad Retainer Repair Kit

WBC 19.5" - 22.5" (Single Piston) series



Original No:

Cross No :

S.No.	Ekersan No.	Ürün Tanıtımı / Description	Ölçü/Dimension	Miktar/Qty.
1	428076	Kaliper Tutucu / Brake Pad Retainer		1
2	429033	Balata Tasiyici Sac /		3
3	425054	Vida / Screw		1
4	423015	Tapa / Plug		1

Tip / Application

19.5" - 22.5" (SINGLE PISTON) SERIES

WABCO

422138

Kaliper Toz Lastığı Takımı / Caliper Tappet & Boot Kit

WBC 19.5" - 22.5" (Double Piston) series

Original No:

Cross No :



S.No.	Ekersan No.	Ürün Tanımı / Description	Ölçü/Dimension	Miktar/Qty.
1	423020	Toz Lastığı / Dust Cover		2
2	422001	Pabuç /		2
3	428028	Selman / O-ring		2

Tip / Application

40 175 025, 026, 027, 028, 049, 050, 051, 052, 060, 061

WABCO

422139

Ayar Civatası Sağ / Caliper Calibration Bolt (Right)

WBC 19.5" - 22.5" (Double Piston) series

Original No:

Cross No :



S.No.	Ekersan No.	Ürün Tanımı / Description	Ölçü/Dimension	Miktar/Qty.
1	422139	Ayar Civatası Sağ / Caliper Calibration Bolt (Right)		1

Tip / Application

19.5" - 22.5" (DOUBLE PISTON) SERIES

WABCO

422140

Ayar Civatası Sol / Caliper Calibration Bolt (Left)

WBC 19.5" - 22.5" (Double Piston) series

Original No:

Cross No :



S.No.	Ekersan No.	Ürün Tanımı / Description	Ölçü/Dimension	Miktar/Qty.
1	422140	Ayar Civatası Sol / Caliper Calibration Bolt (Left)		1

Tip / Application

19.5" - 22.5" (DOUBLE PISTON) SERIES

WABCO

422141

WBC 19.5" - 22.5" (Double Piston) series

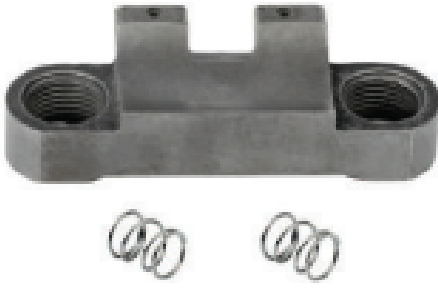

Kaliper Köprü Bağlantısı / Caliper Bridge Assembly

Orjinal No:

Cross No :

S.No.	Ekarsan No.	Ürün Tanıtımı / Description	Ölçü/Dimension	Miktar/Qty.
1	422012	Kaliper Bilya Yasagi / Bearing Support		1
2	427006	Yay Spring		2

Tip / Application

19.5" - 22.5" (DOUBLE PISTON) SERIES

WABCO

DAF / RENAULT

422142

WBC 19.5" - 22.5" (Double Piston) series



Kaliper Toz Lastığı & Perno Takımı / Caliper Boot & Pin Repair Kit

Orjinal No: 3445505 / 5003558732

Cross No : 13899746

S.No.	Ekarsan No.	Ürün Tanıtımı / Description	Ölçü/Dimension	Miktar/Qty.
1	424011	Kaliper Peması / Caliper Bolt	Ø 38x120 mm	1
2	424012	Kaliper Peması / Caliper Bolt	Ø 38x76 mm	1
3	425000	Kaliper Vidası / Caliper Screw	M16x1,5x120 mm	1
4	425004	Kaliper Vidası / Caliper Screw	M16x1,5x80 mm	1
5	422130	Kaliper Toz Lastığı Takımı / Caliper Tappet & Boot Kit		1
6	423009	Koruk Beviz / Bellow (White)	80 mm	2
7	429007	Perno Tapası / Bolt Plug	Ø 42x19 mm	1
8	429008	Perno Tapası / Bolt Plug	Ø 42x17 mm	1
9	428012	Pul Washer	120 mm	2
10	426007	Metal Bunc Bushing		3
11	423015	Tapas Plug		2

Tip / Application

40 195 007, 008, 009, 010, 011, 012, 021, 022

WABCO

422143

WBC 19.5" - 22.5" (Double Piston) series



Kaliper Masura Bilya (Alt) / Caliper Inner Roller Bearing

Orjinal No:

Cross No :

S.No.	Ekarsan No.	Ürün Tanıtımı / Description	Ölçü/Dimension	Miktar/Qty.
1	423702	Masura Bilya Alt / Inner Roller Bearing		2

Tip / Application

19.5" - 22.5" (DOUBLE PISTON) SERIES

WABCO

422144

Kaliper Masura Bilya (Üst) / Caliper Outer Roller Bearing

WBC 19.5" - 22.5" (Double Piston) series

Orjinal No:

Cross No :



S.No.	Ekersan No.	Ürün Tanıtımı / Description	Ölçü/Dimension	Miktar/Qty.
1	423703	Masura Bilya Üst / Outer Roller Bearing		2

Tip / Application

19.5" - 22.5" (DOUBLE PISTON) SERIES

WABCO

422145

Kaliper Kapak Conta Takimi / Caliper Cover Plate Gasket Set

WBC 19.5" - 22.5" (Double Piston) series

Orjinal No:

Cross No :



S.No.	Ekersan No.	Ürün Tanıtımı / Description	Ölçü/Dimension	Miktar/Qty.
1	421006	Kapak Contası / Cover Gasket		1
2	425013	Yida Screw	M16x1,5x40 mm	5
3	425008	Yida Screw	M10x1x40 mm	2

Tip / Application

19.5" - 22.5" (DOUBLE PISTON) SERIES

WABCO

422163

Kaliper Ayar Civatası (Sag) / Caliper Calibration Bolt (Right)

WBC 19.5" - 22.5" (Double Piston) series

Orjinal No:

Cross No :



S.No.	Ekersan No.	Ürün Tanıtımı / Description	Ölçü/Dimension	Miktar/Qty.
1	422339	Ayar Civatası Sag / Caliper Calibration Bolt (Right)		1
2	428059	Kilitleme Sacı /		1
3	428058	Sekman / Clip		1

Tip / Application

19.5" - 22.5" (DOUBLE PISTON) SERIES

WABCO**422164****Kaliper Ayar Civatası (Sol) / Caliper Calibration Bolt (Left)**

WBC 19.5" - 22.5" (Double Piston) series

Orjinal No:

Cross No :



S.No.	Ekersan No.	Ürün Tanımı / Description	Ölçü/Dimension	Miktar/Qty.
1	422160	Ayar Civatası Sol / Caliper Calibration Bolt (Left)		1
2	428059	Kilitleme Sac /		1
3	428058	Sekman / O-ring		1

Tip / Application

19.5" - 22.5" (DOUBLE PISTON) SERIES

WABCO**422165****Kaliper Mekanizma Dislisi (Sağ) / Caliper Adjuster Mechanism Gear (Right)**

WBC 19.5" - 22.5" (Double Piston) series

Orjinal No:

Cross No :



S.No.	Ekersan No.	Ürün Tanımı / Description	Ölçü/Dimension	Miktar/Qty.
1	422075	Ayar Dişlisi Sağ / Adjuster Gear (R)		2

Tip / Application

19.5" - 22.5" (DOUBLE PISTON) SERIES

WABCO**422165-1****Kaliper Mekanizma Dislisi (Sol) / Caliper Adjuster Mechanism Gear (Left)**

WBC 19.5" - 22.5" (Double Piston) series

Orjinal No:

Cross No :



S.No.	Ekersan No.	Ürün Tanımı / Description	Ölçü/Dimension	Miktar/Qty.
1	422076	Ayar Dişlisi Sol / Adjuster Gear (L)		2

Tip / Application

19.5" - 22.5" (DOUBLE PISTON) SERIES

WABCO

422166

Masura Bilya Yatagi / Caliper Adjuster Lever

WBC 19.5" - 22.5" (Double Piston) series

Original No:

Cross No :

S.No.	Ekersan No.	Ürün Tanıtımı / Description	Ölçü/Dimension	Miktar/Qty.
1	422166	Masura Bilya Yatagi / Caliper Adjuster Lever		1

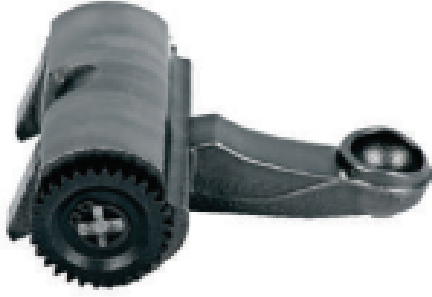

Tip / Application

19.5" - 22.5" (DOUBLE PISTON) SERIES

WABCO

422167

Kaliper Balata Tutucu Tamir Takımı / Caliper Pad Retainer Repair Kit

WBC 19.5" - 22.5" (Double Piston) series

Original No:

Cross No :

S.No.	Ekersan No.	Ürün Tanıtımı / Description	Ölçü/Dimension	Miktar/Qty.
1	428076	Kaliper Tutucu / Brake Pad Retainer		1
2	425031	Balata Tasilyici Sac /		3
3	425054	Vida / Screw		1
4	423015	Tapa / Plug		1



Tip / Application

19.5" - 22.5" (DOUBLE PISTON) SERIES

HALDEX

422034

Kaliper Ayar Pimi / Caliper Adjusting Pin

HALDEX series

Orjinal No:

Cross No :

S.No.	Ekersan No.	Ürün Tanıtımı / Description	Ölçü/Dimension	Miktar/Qty.
1	422034	Kaliper Ayar Pimi / Caliper Adjusting Pin		1

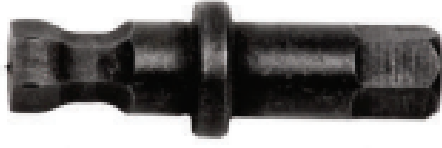

Tip / Application

MARK I, MARK II, MARK IV, MODULE X

HALDEX

423100

Kaliper Perno & Lastik Tamir Takımı / Caliper Pin & Boot Repair Kit

HALDEX series

Orjinal No:

Cross No : 91812

S.No.	Ekersan No.	Ürün Tanıtımı / Description	Ölçü/Dimension	Miktar/Qty.
1	424026	Kaliper Perno / Caliper Bolt	Ø 35x64 mm	4
2	425009	Kaliper Vidası /	M14x2x42 mm	4
3	423033	Toz Lastiği / Dust Cover		6
4	429005	Sac Kapak / Steel Cover	Ø 38x56 mm	4
5	429007	Perno Tapası / Bolt Plug	Ø 40x33 mm	2
6	423035	Plastik Tapa / Plastic Plug		1
7	423036	Plastik Conta / Plastic Gasket		4

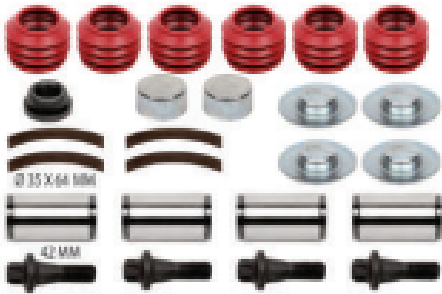

Tip / Application

MODULE X

HALDEX

423101

Kaliper Lastik ve Tapa Takımı / Caliper Boot & Cap Seti

HALDEX series

Orjinal No:

Cross No : 91815

S.No.	Ekersan No.	Ürün Tanıtımı / Description	Ölçü/Dimension	Miktar/Qty.
1	423033	Toz Lastiği / Dust Cover		6
2	429005	Sac Kapak / Steel Cover	Ø 38x56 mm	4
3	429007	Perno Tapası / Bolt Plug	Ø 40x33 mm	2
4	423035	Plastik Tapa / Plastic Plug		1
5	423036	Plastik Conta / Plastic Gasket		4

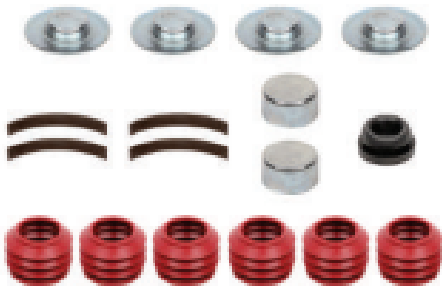

Tip / Application

MODULE X

HALDEX

423102

Kaliper Lastik ve Tapa Takımı / Caliper Boot & Cap Seti

HALDEX series

Orjinal No:

Cross No : 91014



S.No.	Ekersan No.	Ürün Tanıtımı / Description	Ölçü/Dimension	Miktar/Qty.
1	423003	Toz Lastiği / Dust Cover		2
2	429015	Çelik Kapak / Steel Cover	Ø 28x6 mm	4
3	429017	Perno Tapası / Bolt Plug	Ø 4x23 mm	2
4	423035	Plastik Tapa / Plastic Plug		1
5	423036	Plastik Conta / Plastic Gasket		1

Tip / Application

MODULE X

HALDEX

423103

Körük ve Yay Seti / Caliper Dust Cover & Spring Set

HALDEX series

Orjinal No:

Cross No : 89934

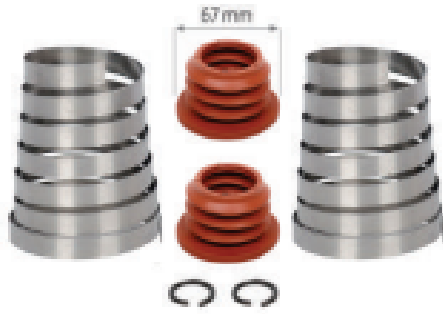

S.No.	Ekersan No.	Ürün Tanıtımı / Description	Ölçü/Dimension	Miktar/Qty.
1	423004	Toz Lastiği / Dust Cover	Ø 67,00 mm	2
2	427006	Çelik Yay /	Ø 67,00 mm	2
3	428022	Sekman / Clip		2

Tip / Application

MARK II, MARK III, MARK IV, MODULE X

HALDEX

423104

Kaliper Balata Tutucu / Caliper Push Plate

HALDEX series

Orjinal No:

Cross No : 92731



S.No.	Ekersan No.	Ürün Tanıtımı / Description	Ölçü/Dimension	Miktar/Qty.
1	423104	Kaliper Balata Tutucu / Caliper Push Plate		1

Tip / Application

MARK IV

HALDEX

423105

Kaliper Körük ve Yay Seti / Caliper Dust Cover & Spring Set

HALDEX series

Orjinal No:

Cross No : 91811



S.No.	Ekersan No.	Ürün Tanıtımı / Description	Ölçü/Dimension	Miktar/Qty.
1	423034	Top Lastığı / Dust Cover	Ø 67,00 mm	2
2	427006	Sac Yay /	Ø 67,00 mm	2
3	428022	Sekman / O-ring		2
4	423035	Plastik Tapa / Plastic Plug		1

Tip / Application

MARK I, MARK II, MARK IV, MODULE X

HALDEX

423106

Kaliper Perno & Lastik Tamir Takımı / Caliper Pin & Boot Repair Kit

HALDEX series

Orjinal No:

Cross No : 89541



S.No.	Ekersan No.	Ürün Tanıtımı / Description	Ölçü/Dimension	Miktar/Qty.
1	424027	Kaliper Perno / Caliper Bolt	Ø 35x70 mm	4
2	425020	Kaliper Vidası /	W18x2x53 mm	4
3	423033	Top Lastığı / Dust Cover		8
4	429015	Sac Kapak / Steel Cover	Ø 28x6 mm	4
5	429006	Perno Tapası / Bolt Plug	Ø 41x57 mm	2
6	423035	Plastik Tapa / Plastic Plug		2
7	423036	Plastik Cora / Plastic Gasket		4
8	428023	Pul Washer	Ø 41,5x3,7 mm	8

Tip / Application

MARK I, MARK II, MARK IV

HALDEX

423107

Kaliper Lastik Tamir Takımı / Caliper Boot Repair Kit

HALDEX series

Orjinal No:

Cross No :



S.No.	Ekersan No.	Ürün Tanıtımı / Description	Ölçü/Dimension	Miktar/Qty.
1	423033	Top Lastığı / Dust Cover		8
2	429006	Perno Tapası / Bolt Plug	Ø 41x57 mm	2
3	423035	Plastik Tapa / Plastic Plug		2
4	423036	Plastik Cora / Plastic Gasket		4
5	428023	Pul Washer	Ø 41,5x3,7 mm	8

Tip / Application

MARK I, MARK II, MARK IV

HALDEX

423108

Kaliper Perno & Lastik Tamir Takimi / Caliper Pin & Boot Repair Kit

HALDEX series

Orjinal No:

Cross No :

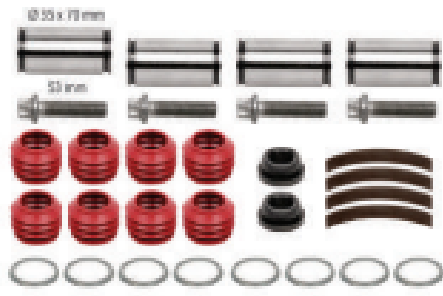

S.No.	Ekensan No.	Ürün Tanıtımı / Description	Ölçü/Dimension	Miktar/Qty.
1	424027	Kaliper Pernosu / Caliper Bolt	Ø 33x70 mm	4
2	425020	Kaliper Videsi /	#116x253 mm	4
3	423033	Toz Lastığı / Dust Cover		8
4	423035	Plastik Tapa / Plastic Plug		2
5	423036	Plastik Conta / Plastic Gasket		4
8	428023	Pul / Washer	Ø 41,5x3,7 mm	8

Tip / Application

MARK II, MARK III, MARK IV

HALDEX

423109

Kaliper Kırık ve Yay Seti / Caliper Dust Cover & Spring Set

HALDEX series

Orjinal No:

Cross No : 87485



S.No.	Ekensan No.	Ürün Tanıtımı / Description	Ölçü/Dimension	Miktar/Qty.
1	423034	Toz Lastığı / Dust Cover	Ø 67,80 mm	2
2	427006	Sac Yay /	Ø 67,80 mm	2
3	428022	Sekman / Clip		2
4	423035	Plastik Tapa / Plastic Plug		2

Tip / Application

MARK II, MARK III, MARK IV, MODULE X

HALDEX

423110

Kaliper Kapak Takimi / Caliper Cover Set

HALDEX series

Orjinal No:

Cross No : 89927



S.No.	Ekensan No.	Ürün Tanıtımı / Description	Ölçü/Dimension	Miktar/Qty.
1	429016	Perno Tapa / Bolt Plug	Ø 41x57 mm	2

Tip / Application

MARK II, MARK III, MARK IV

HALDEX

423111

Kaliper Ayar Vida ve Keçe Tamir Takimi / Caliper Adjusting Bolt & Seals Repair Kit

HALDEX series

Orjinal No:

Cross No : 90493



S.No.	Ekersan No.	Ürün Tanıtım / Description	Ölçü/Dimension	Miktar/Qty.
1	423034	Kaliper Ayar Pimi / Caliper Adjusting Pin		2
2	423035	Plastik Tapa / Plastic Plug		2
3	428021	Kaliper Keçe / Caliper Seal	Ø 6x16x7 mm	2

Tip / Application

MARK I, MARK II, MARK IV, MODULE X

HALDEX

423112

Kaliper Masura Bilya Seti / Caliper Roller Bearing Set

HALDEX series

Orjinal No:

Cross No :



S.No.	Ekersan No.	Ürün Tanıtım / Description	Ölçü/Dimension	Miktar/Qty.
1	423801	Kaliper Masura Bilya / Caliper Roller Bearing		2

Tip / Application

MARK I, MARK II, MARK IV

HALDEX

423113

Kaliper Ayar Civatası Seti / Caliper Calibration Bolt Set

HALDEX series

Orjinal No:

Cross No :



S.No.	Ekersan No.	Ürün Tanıtım / Description	Ölçü/Dimension	Miktar/Qty.
1	423805	Kaliper Ayar Civatası / Caliper Calibration Bolt		1
2	428020	Sekman / Circle		1

Tip / Application

MARK IV

HALDEX**423114****Kaliper Ayar Civatası Set / Caliper Calibration Bolt Set**

HALDEX series

Orjinal No:

Cross No :

S.No.	Ekersan No.	Ürün Tanıtımı / Description	Ölçü/Dimension	Miktar/Qty.
1	423806	Kaliper Ayar Civatası / Caliper Calibration Bolt		1
2	428022	Sekman / Circlip		1

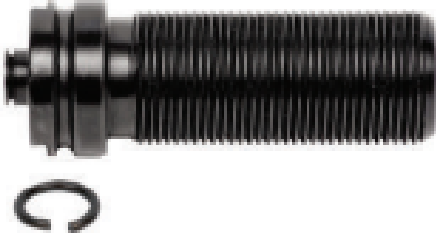
**Tip / Application**

MARK IV

HALDEX**423115****Kaliper Ayar Civatası / Caliper Calibration Bolt**

HALDEX series

Orjinal No:

Cross No :

S.No.	Ekersan No.	Ürün Tanıtımı / Description	Ölçü/Dimension	Miktar/Qty.
1	423115	Kaliper Ayar Civatası / Caliper Calibration Bolt		1

**Tip / Application**

MODULE X

HALDEX**423116****Kaliper Balata Tutucu Ployt Seti / Caliper Pad Retainer Plate Kit**

HALDEX series

Orjinal No:

Cross No :

S.No.	Ekersan No.	Ürün Tanıtımı / Description	Ölçü/Dimension	Miktar/Qty.
1	423804	Kaliper Balata Tutucu / Caliper Push Plate		1
2	423806	Kaliper Ayar Civatası / Caliper Calibration Bolt		2
3	428020	Sekman / Circlip		2

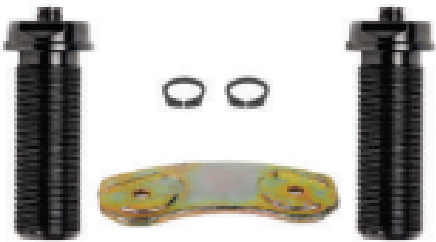
**Tip / Application**

MARK IV

HALDEX**423117**

Masura Bilya Yatagi / Caliper Lever

HALDEX series

Original No:

Cross No :



S.No.	Ekersan No.	Ürün Tanıtımı / Description	Ölçü/Dimension	Miktar/Qty.
1	423117	Masura Bilya Yatagi / Caliper Lever		1

Tip / Application

MODULE X

HALDEX**423118**

Masura Bilya Yatagi / Caliper Lever

HALDEX series

Original No:

Cross No :



S.No.	Ekersan No.	Ürün Tanıtımı / Description	Ölçü/Dimension	Miktar/Qty.
1	423118	Masura Bilya Yatagi / Caliper Lever		1

Tip / Application

MARK I, MARK II, MARK IV

HALDEX**423120**

Köprü Bağlantı Dişlisi / Caliper Intermediate Gear

HALDEX series

Original No:

Cross No :



S.No.	Ekersan No.	Ürün Tanıtımı / Description	Ölçü/Dimension	Miktar/Qty.
1	423120	Köprü Bağlantı Dişlisi / Caliper Intermediate Gear		1

Tip / Application

MODULE X

HALDEX

423121

HALDEX series

Mekanizma Dislisi / Caliper Adjusting Mechanism Gear

Orjinal No:

Cross No :

S.No.	Ekersan No.	Ürün Tanımı / Description	Ölçü/Dimension	Miktar/Qty.
1	423121	Mekanizma Dislisi / Caliper Adjusting Mechanism Gear		1



Tip / Application

MODULE X

HALDEX

423122

HALDEX series

Manuel Ayar Dislisi / Caliper Manuel Adjusting Gear

Orjinal No:

Cross No :

S.No.	Ekersan No.	Ürün Tanımı / Description	Ölçü/Dimension	Miktar/Qty.
1	423122	Manuel Ayar Dislisi / Caliper Manuel Adjusting Gear		1



Tip / Application

MODULE X

HALDEX

423123

HALDEX series

Ayar Mekanizması / Caliper Adjusting Mechanism

Orjinal No:

Cross No :

S.No.	Ekersan No.	Ürün Tanımı / Description	Ölçü/Dimension	Miktar/Qty.
1	423123	Ayar Mekanizması / Caliper Adjusting Mechanism		1



Tip / Application

MODULE X

HALDEX

423124

Kaliper Masura Bilya Seti / Caliper Roller Bearing Set

HALDEX series

Original No:

Cross No :



S.No.	Ekarsan No.	Ürün Tanıtımı / Description	Ölçü/Dimension	Miktar/Qty.
1	423802	Kaliper Masura Bilya / Caliper Roller Bearing		2

Tip / Application

MODULE X

HALDEX

423125

Kaliper Masura Bilya / Caliper Roller Bearing

HALDEX series

Original No:

Cross No :



S.No.	Ekarsan No.	Ürün Tanıtımı / Description	Ölçü/Dimension	Miktar/Qty.
1	423125	Kaliper Masura Bilya / Caliper Roller Bearing		1

Tip / Application

MODULE X

HALDEX

423126

Kaliper Dürbün Takımı / Caliper Shaft Housing Set

HALDEX series

Original No:

Cross No :



S.No.	Ekarsan No.	Ürün Tanıtımı / Description	Ölçü/Dimension	Miktar/Qty.
1	426525	Kaliper Dürbünü / Caliper Bridge Assembly		1
2	428047	Sekman / Circlip		1
3	428048	Raynel / Shim		1
4	427802	Yay / Spring		1

Tip / Application

MODULE X

HALDEX**423127****Kaliper Civata Dislisi (Düz) / Caliper Adjustent Gear (Driven)****HALDEX series****Orjinal No:****Cross No :**

S.No.	Ekarsan No.	Ürün Tanıtımı / Description	Ölçü/Dimension	Miktar/Qty.
1	423090	Kaliper Mekanizması / Caliper Mechanism		1
2	428006	Sekman /		1

Tip / Application

MARK IV

HALDEX**423128****Civata Dislisi (Faturalı) / Caliper Adjustent Gear (Driving)****HALDEX series****Orjinal No:****Cross No :**

S.No.	Ekarsan No.	Ürün Tanıtımı / Description	Ölçü/Dimension	Miktar/Qty.
1	423028	Civata Dislisi (Faturalı) / Caliper Adjustent Gear (Driving)		1

Tip / Application

MARK IV

HALDEX**423129****Mekanizma Tutma Sacı / Caliper Mechanism Clamp****HALDEX series****Orjinal No:****Cross No :**

S.No.	Ekarsan No.	Ürün Tanıtımı / Description	Ölçü/Dimension	Miktar/Qty.
1	423029	Mekanizma Tutma Sacı / Caliper Mechanism Clamp		1

Tip / Application

MODULE X

HALDEX

423130

Mekanizma Sacı / Caliper Mechanism Plate

HALDEX series

Orjinal No:

Cross No :



S.No.	Ekersan No.	Ürün Tanıtımı / Description	Ölçü/Dimension	Miktar/Qty.
1	423130	Mekanizma Sacı / Caliper Mechanism Plate		1

Tip / Application

MODULE X

HALDEX

423131

Kaliper Perno & Lastik Tamir Takımı / Caliper Pin & Boot Repair Kit

HALDEX series

Orjinal No:

Cross No : 93299

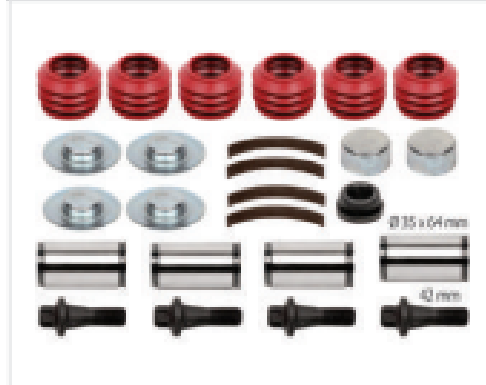

S.No.	Ekersan No.	Ürün Tanıtımı / Description	Ölçü/Dimension	Miktar/Qty.
1	429034	Kaliper Perno / Caliper Bolt	Ø 15x14 mm	4
2	425009	Kaliper Vidası /	M14x242 mm	4
3	423033	Toz Lastığı / Dust Cover		6
4	429015	Sac Kapak / Steel Cover	Ø 28x8 mm	4
5	429017	Perno Tapası / Bolt Plug	Ø 42x13 mm	2
6	423035	Plastik Tapa / Plastic Plug		1
7	423036	Plastik Conta / Plastic Gasket		4

Tip / Application

MARK I, MARK II, MARK IV

HALDEX

423133

Kaliper Körük ve Tapa Tamir Takımı / Caliper Boot Repair Kit

HALDEX series

Orjinal No:

Cross No :

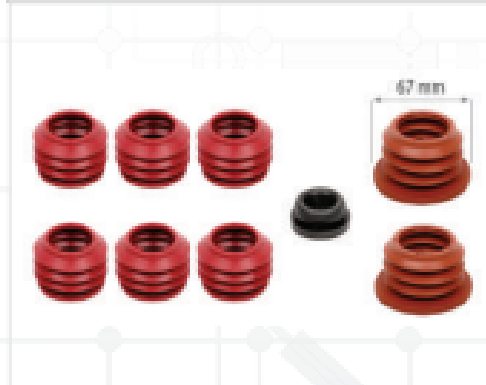

S.No.	Ekersan No.	Ürün Tanıtımı / Description	Ölçü/Dimension	Miktar/Qty.
1	423033	Toz Lastığı / Dust Cover		6
2	423034	Toz Lastığı / Dust Cover	Ø 47,00 mm	2
3	423035	Plastik Tapa / Plastic Plug		1

Tip / Application

MARK I, MARK II, MARK IV, MODULE X

HALDEX

423134

Kaliper Rulmanı / Caliper Roller Bearing

HALDEX series

Original No:

Cross No :



S.No.	Ekersan No.	Ürün Tanıtımı / Description	Ölçü/Dimension	Miktar/Qty.
1	423134	Kaliper Rulmanı / Caliper Roller Bearing		1

Tip / Application

MARK II, MARK III, MARK IV

HALDEX

423135

Masura Bilya Yatak Pimi / Caliper Lever Pin

HALDEX series

Original No:

Cross No :



S.No.	Ekersan No.	Ürün Tanıtımı / Description	Ölçü/Dimension	Miktar/Qty.
1	423135	Masura Bilya Yatak Pimi / Caliper Lever Pin		1

Tip / Application

MARK II, MARK III, MARK IV

HALDEX

423136

Kaliper Ayar Mekanizması / Caliper Adjusting Mechanism

HALDEX series

Original No:

Cross No :



S.No.	Ekersan No.	Ürün Tanıtımı / Description	Ölçü/Dimension	Miktar/Qty.
1	422071	Kaliper Mekanizması / Caliper Mechanism		1
2	428048	Sekman /		1

Tip / Application

MARK II, MARK III, MARK IV

HALDEX

423137

Kaliper Dürbün Takımı / Caliper Shaft Housing Set

HALDEX series

Orjinal No:

Cross No :



S.No.	Ekensan No.	Ürün Tanıtımı / Description	Ölçü/Dimension	Miktar/Qty.
1	420536	Kaliper Dürbünü / Caliper Bridge Assembly		1
2	420047	Sekman / O-ring		1
3	420048	Raynel / Shim		1
4	420002	Yay / Spring		1

Tip / Application

MARK I, MARK II, MARK IV

HALDEX

423140

Kaliper Kapak Takımı (Döküm) / Caliper Cover Set (Casting)

HALDEX series

Orjinal No:

Cross No :



S.No.	Ekensan No.	Ürün Tanıtımı / Description	Ölçü/Dimension	Miktar/Qty.
1	422069	Kaliper Kapak (Döküm) / Caliper Cover (Casting)		1
2	420047	Yılda / Screw	M8x1,25x45 mm	4

Tip / Application

MARK I, MARK II, MARK IV

HALDEX

423141

Kaliper Mekanizma Sabitleme Yayı / Caliper Mechanism Clamp

HALDEX series

Orjinal No:

Cross No :

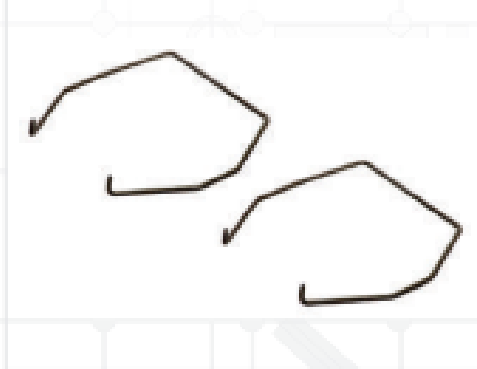

S.No.	Ekensan No.	Ürün Tanıtımı / Description	Ölçü/Dimension	Miktar/Qty.
1	420045	Sabitleme Yayı / Mechanism Clamp		2

Tip / Application

MARK I, MARK II, MARK IV

423143

Kaliper Mekanizma Metal Üst Kapak Seti / Caliper Mechanism Top Cover Set

HALDEX series

Orjinal No:

Cross No :



S.No. Ekerson No. Ürün Tanıtımı / Description Ölçü/Dimension Miktar/Qty.

S.No.	Ekerson No.	Ürün Tanıtımı / Description	Ölçü/Dimension	Miktar/Qty.
1	422090	Kaliper Kapagi (Döküm) / Caliper Cover (Casting)		1
2	422034	Kaliper Ayar Pimi / Caliper Adjusting Pin		2
3	428021	Kaliper Keçe / Caliper Seal	Ø 8x16x7 mm	2

Tip / Application

MARK II, MARK III, MARK IV

423144

Komple Mekanizma Seti / Caliper Mechanism Complete Set

HALDEX series

Orjinal No:

Cross No :



S.No. Ekerson No. Ürün Tanıtımı / Description Ölçü/Dimension Miktar/Qty.

S.No.	Ekerson No.	Ürün Tanıtımı / Description	Ölçü/Dimension	Miktar/Qty.
1	423003	Könk ve Yay Seti / Caliper Dust Cover & Spring Set	Ø 67,80 mm	1
2	423137	Kaliper Döbün Takımı / Caliper Shaft Housing Set		1
3	423113	Kaliper Ayar Civatası Seti / Caliper Calibration Bolt Set		2
4	423020	Köprü Bağlantı Dişlisi / Caliper Intermediate Gear		1
5	423127	Kaliper Civata Dişlisi (Döğ) / Caliper Adjustment Gear (Driven)		1
6	423128	Civata Dişlisi (Fatura) / Caliper Adjustment Gear (Driving)		1
7	423136	Kaliper Ayar Mekanizması / Caliper Adjusting Mechanism		1
8	423117	Masura Bilya Yatağı / Caliper Lever		1
9	423135	Masura Bilya Yatak Pimi / Caliper Lever Pin		1
10	423112	Kaliper Masura Bilya Seti / Caliper Roller Bearing Set		1
11	423134	Kaliper Rulmanı / Caliper Roller Bearing		1
12	423104	Kaliper Balata Tutucu / Caliper Push Plate		1
13	423140	Kapak Takımı (Döküm) / Cover Set (Casting)		1
14	423141	Mekanizma Sabitleme Yığı / Mechanism Clamp		1
15	423143	Metal Üst Kapak Seti / Mechanism Top Cover Set		1

Tip / Application

MARK II, MARK III, MARK IV

423145

Kaliper Perno & Lastik Tamir Takımı / Caliper Pin & Boot Repair Kit

HALDEX series

Orjinal No:

Cross No : 87484



S.No. Ekerson No. Ürün Tanıtımı / Description Ölçü/Dimension Miktar/Qty.

S.No.	Ekerson No.	Ürün Tanıtımı / Description	Ölçü/Dimension	Miktar/Qty.
1	424038	Kaliper Pernosu / Caliper Bolt	Ø 35x69 mm	4
2	425049	Kaliper Vidası /	M14x51 mm	4
3	423033	Toz Lastığı / Dust Cover		8
4	429025	Sac Kapak / Steel Cover		4
5	423035	Plastik Tapa / Plastic Plug		2
6	423036	Plastik Conta / Plastic Gasket		3
7	428023	Pul / Washer	Ø 41,5x3,7 mm	8

Tip / Application

22.5"

HALDEX

423147

Kaliper K r k ve Yay Seti / Caliper Boot & Spring Repair Kit

HALDEX series

Orjinal No:

Cross No :



S.No.	Ekersan No.	�r�n Tanıtımı / Description	�k�/Dimension	Miktar/Qty.
1	423071	Toz Lastiđi / Dust Cover	� 78,50 mm	2
2	427026	Sac Yay / Spring		2
3	428022	Sekman / Circlip		2
4	423035	Plastik Tapa / Plastic Plug		1

Tip / Application

22.5"

HALDEX

423148

Kaliper Yay Takimi / Caliper Spring Kit

HALDEX series

Orjinal No:

Cross No :



S.No.	Ekersan No.	�r�n Tanıtımı / Description	�k�/Dimension	Miktar/Qty.
1	427026	Sac Yay / Spring		2

Tip / Application

22.5"

HALDEX

423149

Kaliper Ayar Vida Takimi / Caliper Calibration Bolt Set

HALDEX series

Orjinal No:

Cross No :



S.No.	Ekersan No.	�r�n Tanıtımı / Description	�k�/Dimension	Miktar/Qty.
1	425050	Ayar Vidadı Sađ / Adjusting Bolt (R)		1
2	425051	Ayar Vidadı Sol /		1

Tip / Application

22.5"

HALDEX

423150

Ayar Mekanizması / Caliper Adjusting Mechanism

HALDEX series

Orjinal No:

Cross No :



S.No.	Ekansan No.	Ürün Tanıtımı / Description	Ölçü/Dimension	Miktar/Qty.
1	423250	Ayar Mekanizması / Caliper Adjusting Mechanism		1

Tip / Application

22.5"

HALDEX

423151

Kaliper Kapak Takımı (Döküm) / Caliper Cover Set (Casting)

HALDEX series

Orjinal No:

Cross No :



S.No.	Ekansan No.	Ürün Tanıtımı / Description	Ölçü/Dimension	Miktar/Qty.
1	422089	Kaliper Kapak (Döküm) / Caliper Cover (Casting)		1
2	425060	Yida Screw	M8x1,25x60 mm	4
3	429040	Ayar Somunu / Adjusting Nut		4

Tip / Application

22.5"

HALDEX

423152

Kaliper Mekanizması Sabitleme Yayı / Caliper Mechanism Clamp

HALDEX series

Orjinal No:

Cross No :



S.No.	Ekansan No.	Ürün Tanıtımı / Description	Ölçü/Dimension	Miktar/Qty.
1	428062	Sabitleme Yayı / Mechanism Clamp		2

Tip / Application

22.5"

HALDEX

423153

Masura Bilya Yatagi / Caliper Lever

HALDEX series

Orjinal No:

Cross No :



S.No.	Ekersan No.	Ürün Tanıtımı / Description	Ölçü/Dimension	Miktar/Qty.
1	423053	Masura Bilya Yatagi / Caliper Lever		1

Tip / Application

22.5"

HALDEX

423154

Kaliper Rulmanlari Set / Caliper Roller Bearings Set

HALDEX series

Orjinal No:

Cross No :



S.No.	Ekersan No.	Ürün Tanıtımı / Description	Ölçü/Dimension	Miktar/Qty.
1	423003	Kaliper Rulmanlari / Caliper Roller Bearings		2

Tip / Application

22.5"

HALDEX

423155

Kaliper Rulmanlari Set / Caliper Roller Bearings Set

HALDEX series

Orjinal No:

Cross No :



S.No.	Ekersan No.	Ürün Tanıtımı / Description	Ölçü/Dimension	Miktar/Qty.
1	423004	Kaliper Rulmanlari / Caliper Roller Bearings		2

Tip / Application

22.5"

423157

Masura Bilya Yatak Pimi / Caliper Lever Pin

HALDEX series

Orjinal No:

Cross No :



S.No.	Ekersan No.	Ürün Tanıtımı / Description	Ölçü/Dimension	Miktar/Qty.
1	423157	Masura Bilya Yatak Pimi / Caliper Lever Pin		1

Tip / Application

MODULE X

423158

Kaliper Balata Tutucu Takımı / Caliper Pad Retainer Set

HALDEX series

Orjinal No:

Cross No :



S.No.	Ekersan No.	Ürün Tanıtımı / Description	Ölçü/Dimension	Miktar/Qty.
1	423072	Balata Tutucu / Brake Pad Retainer		1
2	429030	Vida - Screw		1

Tip / Application

MODULE X

423159

Kaliper Kapak Takımı (Döküm) / Caliper Cover Set (Casting)

HALDEX series

Orjinal No:

Cross No :



S.No.	Ekersan No.	Ürün Tanıtımı / Description	Ölçü/Dimension	Miktar/Qty.
1	423070	Kaliper Kapak (Döküm) / Caliper Cover (Casting)		1
2	425048	Vida - Screw	M8x1,25x30 mm	4

Tip / Application

MODULE X

Orjinal No:

Cross No :



Tip / Application

MODULE X

S.No.	Ekansan No.	Ürün Tanımı / Description	Ölçü/Dimension	Miktar/Qty.
1	423103	Koruk ve Yay Seti / Caliper Dust Cover & Spring Set	Ø 67,90 mm	1
2	423126	Kaliper Döndürme Takımı / Caliper Shaft Housing Set		1
3	423015	Kaliper Ayar Civatası / Caliper Calibration Bolt		2
4	423120	Köprü Bağlantı Dişlisi / Caliper Intermediate Gear		1
5	423121	Mekanizma Dişlisi / Caliper Adjusting Mechanism Gear		1
6	423122	Manuel Ayar Dişlisi / Caliper Manual Adjusting Gear		1
7	423123	Ayar Mekanizması / Caliper Adjusting Mechanism		1
8	423157	Mazara Bilya Yatağı Pimi / Caliper Lever Pin		1
9	423124	Kaliper Mazara Bilya Seti / Caliper Roller Bearing Set		1
10	423125	Kaliper Mazara Bilya / Caliper Roller Bearing		1
11	423117	Mazara Bilya Yatağı / Caliper Lever		1
12	423129	Mekanizma Tutma Sacı / Mechanism Clamp		1
13	423130	Mekanizma Sacı / Mechanism Plate Kapak		1
14	423159	Takım (Döküm) / Cover Set (Casting)		1
15	423034	Kaliper Ayar Pimi / Caliper Adjusting Pin		1
16	423035	Plastik Tapa / Plastic Plug		1
17	428021	Kaliper Keçe / Caliper Seal	Ø 8x16x7 mm	1

Z-CAM

425100

Ayar Mekanizması Sol / Adjusting Mechanism (Left)

Z-CAM series

Original No: 900868117 / 3057093 / 212909 / 6550270

Cross No :



S.No.	Ekersan No.	Ürün Tanıtım / Description	Ölçü/Dimension	Miktar/Qty.
1	425100	Ayar Mekanizması Sol / Adjusting Mechanism (Left)		1

Tip / Application

F12-FH12/16-FL7/10-NL10/12-B10/12

425101

Ayar Mekanizması Sağ / Adjusting Mechanism (Right)

Z-CAM series

Original No: 900868118 / 3057100 / 212908 / 6550271 / 3824203 / 61131505 / A104062

Cross No :



S.No.	Ekersan No.	Ürün Tanıtım / Description	Ölçü/Dimension	Miktar/Qty.
1	425101	Ayar Mekanizması Sağ / Adjusting Mechanism (Right)		1

Tip / Application

F12-FH12/16-FL7/10-NL10/12-B10/12

425102

Ayar Pinyon Disli Sağ / Adjusting Pinion (Right)

Z-CAM series

Original No: 900868126 / 3096425

Cross No :



S.No.	Ekersan No.	Ürün Tanıtım / Description	Ölçü/Dimension	Miktar/Qty.
1	425102	Ayar Pinyon Disli Sağ / Adjusting Pinion (Right)		1

Tip / Application

F12-FH12/16-FL7/10-NL10/12-B10/12

Z-CAM

RENAULT / DAF / VOLVO

425103

Ayar Pinyon Disli Sol / Adjusting Pinion (Left)

Z-CAM series

Orjinal No: 500196025 / 189004

Cross No :



S.No.	Ekersan No.	Ürün Tanımı / Description	Ölçü/Dimension	Miktar/Qty.
1	425103	Ayar Pinyon Disli Sol / Adjusting Pinion (Left)		1

Tip / Application

F12-FH12/16-FL7/10-NL10/12-B10/12

Z-CAM

RENAULT / VOLVO

425104

Ayar Çapraz Disli / Cross Shaft

Z-CAM series

Orjinal No: 500196021 / 272310

Cross No :



S.No.	Ekersan No.	Ürün Tanımı / Description	Ölçü/Dimension	Miktar/Qty.
1	425104	Ayar Çapraz Disli / Cross Shaft		1

Tip / Application

F12-FH12/16-FL7/10-NL10/12-B10/12

Z-CAM

VOLVO

425105

Ayar Pinyonu Yayli Sag / Adjusting Pinion (Right)

Z-CAM series

Orjinal No: 3006775 / 3000290 / 3003003

Cross No :



S.No.	Ekersan No.	Ürün Tanımı / Description	Ölçü/Dimension	Miktar/Qty.
1	425105	Ayar Pinyonu Yayli Sag / Adjusting Pinion (Right)		1

Tip / Application

NL1 10/12-B10/12-FH12/16

425106

Ayar Pinyonu Yaylı Sol / Adjusting Pinion (Left)

Z-CAM series

Original No: 1807502 / 3890581 / 1003025

Cross No :



S.No.	Ekersan No.	Ürün Tanımı / Description	Ölçü/Dimension	Miktar/Qty.
1	425106	Ayar Pinyonu Yaylı Sol / Adjusting Pinion (Left)		1

Tip / Application

NL1 10/12-B10/12-FH12/16

425107

Ayar Pinyonu Yaylı Sağ / Adjusting Pinion (Right)

Z-CAM series

Original No:

Cross No :



S.No.	Ekersan No.	Ürün Tanımı / Description	Ölçü/Dimension	Miktar/Qty.
1	425107	Ayar Pinyonu Yaylı Sağ / Adjusting Pinion (Right)		1

Tip / Application

NL10/12-B10/12-FH12/16

425108

Ayar Pinyonu Yaylı Sol / Adjusting Pinion (Left)

Z-CAM series

Original No:

Cross No :



S.No.	Ekersan No.	Ürün Tanımı / Description	Ölçü/Dimension	Miktar/Qty.
1	425108	Ayar Pinyonu Yaylı Sol / Adjusting Pinion (Left)		1

Tip / Application

NL10/12-B10/12-FH12/16

425109

Fren Ayar Pinyon Seti (Sag) / Adjusting Pinion Set (Right)

Z-CAM series

Original No: 22207

Cross No :



S.No.	Ekersan No.	Ürün Tanımı / Description	Ölçü/Dimension	Miktar/Qty.
1	428072	Kaliper Ayar Pimi / Caliper Adjusting Pin		1
2	422083	Kaliper Ayar Diđisi /		1
3	425126	Ayar Pinyon Diđi(Sag) / Adjusting Pinion (Right- Short)	Kısa / Short	1
4	425120	Ayar Kilit Takımı Sag / Reverse Lock (Right)		1
5	428071	Öring Büyük / O-Ring Large		1
6	428070	Öring Küçük / O-Ring Small		1

Tip / Application

NL10/12-B10/12-FH12/16

425110

Fren Ayar Pinyon Seti (Sol) / Adjusting Pinion Set (Left)

Z-CAM series

Original No: 22206

Cross No :



S.No.	Ekersan No.	Ürün Tanımı / Description	Ölçü/Dimension	Miktar/Qty.
1	428072	Kaliper Ayar Pimi / Caliper Adjusting Pin		1
2	422083	Kaliper Ayar Diđisi /		1
3	425127	Ayar Pinyon Diđi(Sol) / Adjusting Pinion (Left - Short)	Kısa / Short	1
4	425121	Ayar Kilit Takımı Sol / Reverse Lock (Left)		1
5	428071	Öring Büyük / O-Ring Large		1
6	428070	Öring Küçük / O-Ring Small		1

Tip / Application

NL10/12-B10/12-FH12/16

425111

Fren Ayar Pim Takımı / Adjusting Pin Set

Z-CAM series

Original No: 22096

Cross No :



S.No.	Ekersan No.	Ürün Tanımı / Description	Ölçü/Dimension	Miktar/Qty.
1	428072	Kaliper Ayar Pimi / Caliper Adjusting Pin		1
2	422083	Kaliper Ayar Diđisi /		1
3	428071	Öring Büyük / O-Ring Large		1
4	428070	Öring Küçük / O-Ring Small		1

Tip / Application

F12-FH12/16-FL7/10-NL10/12-B10/12

425112

Fren Ayar Pim Takimi / Adjusting Pin Set

Z-CAM series

Orjinal No: 743309394 / 270206 / 3092964

Cross No :



S.No.	Ekersan No.	Ürün Tanıtımı / Description	Ölçü/Dimension	Miktar/Qty.
1	425123	Kaliper Ayar Pimi / Adjusting Pin		1
2	425124	Krom Dişli Yeni Model / Chrome Gear New Model		1
3	428071	O-ring Büyük / O-Ring Large		1
4	428070	O-ring Küçük / O-Ring Small		1
5	423070	Plastik Kapak / Plastic Cover		1

Tip / Application

F12-FH12/16-FL7/10-NL10/12-B10/12

425113

Fren Ayar Pim Takimi / Adjusting Pin Set

Z-CAM series

Orjinal No: 270028

Cross No :



S.No.	Ekersan No.	Ürün Tanıtımı / Description	Ölçü/Dimension	Miktar/Qty.
1	425123	Kaliper Ayar Pimi / Adjusting Pin		1
2	425125	Krom Dişli Eski Model / Chrome Gear Old Model		1
3	428071	O-ring Büyük / O-Ring Large		1
4	428070	O-ring Küçük / O-Ring Small		1
5	423070	Plastik Kapak / Plastic Cover		1

Tip / Application

F12-FH12/16-FL7/10-NL10/12-B10/12

425114

Fren Ayar Pimi / Adjusting Pin

Z-CAM series

Orjinal No: 3097299 / 1898346

Cross No :



S.No.	Ekersan No.	Ürün Tanıtımı / Description	Ölçü/Dimension	Miktar/Qty.
1	425114	Fren Ayar Pimi / Adjusting Pin		1

Tip / Application

F12-FH12/16-FL7/10-NL10/12-B10/12

Z-CAM

RENAULT / VOLVO

425115

Fren Ayar Pimi / Adjusting Pin

Z-CAM series

Orjinal No: 500190020 / 1800046

Cross No :



S.No.	Ekersan No.	Ürün Tanıtımı / Description	Ölçü/Dimension	Miktar/Qty.
1	425115	Fren Ayar Pimi / Adjusting Pin		1

Tip / Application

F12-FH12/16-FL7/10-NL10/12-B10/12

Z-CAM

RENAULT / VOLVO / MERITOR

425116

Ayar Toz Kapagi / Cover

Z-CAM series

Orjinal No: 500190027 / 3006440 / 1800062

Cross No :



S.No.	Ekersan No.	Ürün Tanıtımı / Description	Ölçü/Dimension	Miktar/Qty.
1	425116	Ayar Toz Kapagi / Cover		1

Tip / Application

F12-FH12/16-FL7/10-NL10/12-B10/12

Z-CAM

VOLVO

425117

Ayar Toz Kapak Contasi / Dust Cover Gasket

Z-CAM series

Orjinal No: 3006450

Cross No :



S.No.	Ekersan No.	Ürün Tanıtımı / Description	Ölçü/Dimension	Miktar/Qty.
1	425117	Ayar Toz Kapak Contasi / Dust Cover Gasket		1

Tip / Application

F12-FH12/16-FL7/10-NL10/12-B10/12

425118

Fren Ayar Toz Keçesi / Dust Seal

Z-CAM series

Orjinal No: 300186013 / 3296448 / 3297092 / 3297094

Cross No : 68132418



S.No.	Ekersan No.	Ürün Tanıtımı / Description	Ölçü/Dimension	Miktar/Qty.
1	425118	Fren Ayar Toz Keçesi / Dust Seal		1

Tip / Application

F12-FH12/16-FL7/10-NL10/12-B10/12

425119

Fren Ayar (C) Yayı / Return Spring

Z-CAM series

Orjinal No: 300186013 / 3296444 / 3297092 / 68132118 / 327098

Cross No :



S.No.	Ekersan No.	Ürün Tanıtımı / Description	Ölçü/Dimension	Miktar/Qty.
1	425119	Fren Ayar (C) Yayı / Return Spring		1

Tip / Application

F12-FH12/16-FL7/10-NL10/12-B10/12

425120

Ayar Kilit Takımı Sağ / Reverse Lock (Right)

Z-CAM series

Orjinal No:

Cross No :

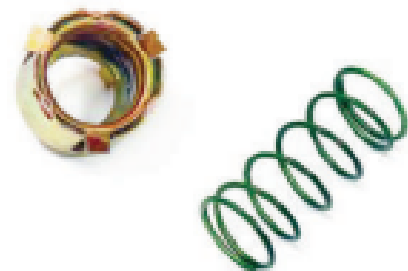

S.No.	Ekersan No.	Ürün Tanıtımı / Description	Ölçü/Dimension	Miktar/Qty.
1	425120	Ayar Kilit Takımı Sağ / Reverse Lock (Right)		1

Tip / Application

F12-FH12/18-FL7/10-NL10/12-B10/12

Z-CAM

425121

Ayar Kilit Takimi Sol / Reverse Lock (Left)

Z-CAM series

Orjinal No:

Cross No :



S.No.	Ekersan No.	Ürün Tanıtımı / Description	Ölçü/Dimension	Miktar/Qty.
1	425121	Ayar Kilit Takimi Sol / Reverse Lock (Left)		1

Tip / Application

F12-FH12/16-FL7/10-NL10/12-B10/12

Z-CAM

425122

Mekanizma Kapak Seti / Cover Set

Z-CAM series

Orjinal No: 272904

Cross No :



S.No.	Ekersan No.	Ürün Tanıtımı / Description	Ölçü/Dimension	Miktar/Qty.
1	425122	Mekanizma Kapak Seti / Cover Set		1

Tip / Application

F12-FH12/16-FL7/10-NL10/12-B10/12

Z-CAM

425123

Kaliper Ayar Pimi / Adjusting Pin

Z-CAM series

Orjinal No:

Cross No :



S.No.	Ekersan No.	Ürün Tanıtımı / Description	Ölçü/Dimension	Miktar/Qty.
1	425123	Kaliper Ayar Pimi / Adjusting Pin		1

Tip / Application

F12-FH12/16-FL7/10-NL10/12-B10/12

Z-CAM

425124

Krom Disli Yeni Model / Chrome Gear New Model

Z-CAM series

Orjinal No:

Cross No :



S.No.	Ekersan No.	Ürün Tanıtımı / Description	Ölçü/Dimension	Miktar/Qty.
1	425124	Krom Disli Yeni Model / Chrome Gear New Model		1

Tip / Application

F12-FH12/16-FL7/10-NL10/12-B10/12

Z-CAM

425125

Krom Disli Eski Model / Chrome Gear Old Model

Z-CAM series

Orjinal No:

Cross No :



S.No.	Ekersan No.	Ürün Tanıtımı / Description	Ölçü/Dimension	Miktar/Qty.
1	425125	Krom Disli Eski Model / Chrome Gear Old Model		1

Tip / Application

F12-FH12/16-FL7/10-NL10/12-B10/12

Z-CAM

425126

Ayar Pinyon Disli Sag / Adjusting Pinion (Right - Short)

Z-CAM series

Orjinal No:

Cross No :



S.No.	Ekersan No.	Ürün Tanıtımı / Description	Ölçü/Dimension	Miktar/Qty.
1	425126	Ayar Pinyon Disli Sag / Adjusting Pinion (Right - Short)	Kısa / Short	1

Tip / Application

F12-FH12/16-FL7/10-NL10/12-B10/12

425127

Ayar Pinyon Disi Sol / Adjusting Pinion (Left - Short)

Z-CAM series

Orjinal No:

Cross No :



S.No.	Ekersan No.	Ürün Tanıtımı / Description	Ölçü/Dimension	Miktar/Qty.
1	425127	Ayar Pinyon Disi Sol / Adjusting Pinion (Left - Short)	Kısa / Short	1

Tip / Application

F12-FH12/16-FL7/10-NL10/12-B10/12

425128

Fren Ayar Toz Kapak Conta Takimi / Gasket Set

Z-CAM series

Orjinal No: 272905

Cross No :



S.No.	Ekersan No.	Ürün Tanıtımı / Description	Ölçü/Dimension	Miktar/Qty.
1	425117	Ayar Toz Kapak Contası / Dust Cover Gasket		1
2	428073	Kaliper Keçesi /		2
3	428074	Oring / O-Ring		2
4	428071	Oring Büyük / O-Ring Large		1
5	428070	Oring Küçük / O-Ring Small		1

Tip / Application

F12-FH12/16-FL7/10-NL10/12-B10/12

IVECO

IVECO

IVECO

425200

Fren Ayar Kaması / Wedge For Brake

Ø 410 SIMPLEX GRUBU

Orjinal No: 93262621

Cross No :

S.No.	Ekersan No.	Ürün Tanıtımı / Description	Ölçü/Dimension	Miktar/Qty.
1	425200	Fren Ayar Kaması / Wedge For Brake		1



Tip / Application

IVECO

425213

Ayar Mandalı İnce Dis / Brake Adjusting Latch (Thin Teeth)

Ø 410 SIMPLEX GRUBU

Orjinal No:

Cross No :

S.No.	Ekersan No.	Ürün Tanıtımı / Description	Ölçü/Dimension	Miktar/Qty.
1	425213	Ayar Mandalı İnce Dis / Brake Adjusting Latch (Thin Teeth)		1



Tip / Application

IVECO

IVECO

425215

Ayar Civatası / Adjusting Bolt

Ø 410 SIMPLEX GRUBU

Orjinal No: 42531676 / A22297E1907 / A229758287 / 6C462A205AA

Cross No :

S.No.	Ekersan No.	Ürün Tanıtımı / Description	Ölçü/Dimension	Miktar/Qty.
1	425215	Ayar Civatası / Adjusting Bolt		1



425217

Toz Lastiđi (Silikon) / Dust Cover (Silicon)

ø 410 SIMPLEX GRUBU

Orjinal No: 42531677

Cross No :



S.No.	Ekersan No.	Ürün Tanıtımı / Description	Ölçü/Dimension	Miktar/Qty.
1	425217	Toz Lastiđi Silikon / Dust Cover (Silicon)		1

Tip / Application

425218

Fren Ayar Pistonu / Adjusting Piston

ø 410 SIMPLEX GRUBU

Orjinal No:

Cross No :



S.No.	Ekersan No.	Ürün Tanıtımı / Description	Ölçü/Dimension	Miktar/Qty.
1	425218	Fren Ayar Pistonu / Adjusting Piston		1

Tip / Application

ø 38.50 X 55.50 MM

425233

Ayar Somunu İnce Dis / Adjusting Nut (Thin Teeth)

ø 410 SIMPLEX GRUBU

Orjinal No:

Cross No :



S.No.	Ekersan No.	Ürün Tanıtımı / Description	Ölçü/Dimension	Miktar/Qty.
1	425233	Ayar Somunu İnce Dis / Adjusting Nut (Thin Teeth)	49 mm	1

Tip / Application

LENGHT: 49 MMBOY: 49 MM

IVECO

425234

Bağlantı Pistonu Sol / Connection Piston (Left 15°)

ø 410 SIMPLEX GRUBU

Orjinal No:

Cross No :



S.No.	Ekersan No.	Ürün Tanıtımı / Description	Ölçü/Dimension	Miktar/Qty.
1	425234	Bağlantı Pistonu Sol / Connection Piston (Left 15°)	15°	1

Tip / Application

IVECO

425235

Bağlantı Pistonu Sol / Connection Piston (Left 5°)

ø 410 SIMPLEX GRUBU

Orjinal No:

Cross No :



S.No.	Ekersan No.	Ürün Tanıtımı / Description	Ölçü/Dimension	Miktar/Qty.
1	425235	Bağlantı Pistonu Sol / Connection Piston (Left 5°)	5°	1

Tip / Application

IVECO

425236

Bağlantı Pistonu Sağ / Connection Piston (Right 15°)

ø 410 SIMPLEX GRUBU

Orjinal No:

Cross No :



S.No.	Ekersan No.	Ürün Tanıtımı / Description	Ölçü/Dimension	Miktar/Qty.
1	425236	Bağlantı Pistonu Sağ / Connection Piston (Right 15°)	15°	1

Tip / Application

IVECO

425237

Ø 410 SIMPLEX GRUBU

Bağlantı Pistonu Sağ / Connection Piston (Right 5°)

Orjinal No:

Cross No :



Tip / Application

S.No.	Ekersan No.	Ürün Tanıtımı / Description	Ölçü/Dimension	Miktar/Qty
1	425237	Bağlantı Pistonu Sağ / Connection Piston (Right 5°)	5°	1

IVECO

425238

Ø 410 SIMPLEX GRUBU

Geri Getirme Yayısı / Return Spring

Orjinal No:

Cross No :



Tip / Application

WIRE DIAMETER: 3.50 MMTEL ÇAPİ: 3.50 MM*

S.No.	Ekersan No.	Ürün Tanıtımı / Description	Ölçü/Dimension	Miktar/Qty
1	425238	Geri Getirme Yayısı / Return Spring	Ø 3,5 mm	1

IVECO

425239

Ø 410 SIMPLEX GRUBU

Geri Getirme Yayısı / Return Spring

Orjinal No:

Cross No :



S.No.	Ekersan No.	Ürün Tanıtımı / Description	Ölçü/Dimension	Miktar/Qty
1	425239	Geri Getirme Yayısı / Return Spring	Ø 4 mm	1

425240

Körük Boğaz Somunu (Uzun) / Locknut (Long)

ø 410 SIMPLEX GRUBU

Orjinal No: 93163852

Cross No :

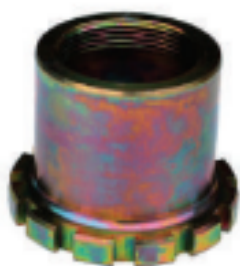

S.No.	Ekersan No.	Ürün Tanıtımı / Description	Ölçü/Dimension	Miktar/Qty.
1	425240	Körük Boğaz Somunu Uzun / Locknut (Long)		1

Tip / Application

425241

Baskı Kelepçe Seti / Pressure Clip Set

ø 410 SIMPLEX GRUBU

Orjinal No:

Cross No :



S.No.	Ekersan No.	Ürün Tanıtımı / Description	Ölçü/Dimension	Miktar/Qty.
1	425309	Baskı Kelepçesi / Pressure Clip		1
2	425311	Civata Seti /		1

Tip / Application

425204

Fren Yay Takimi / Return Spring Set

Ø 410 SIMPLEX KIT GRUBU

Orjinal No: 93163627

Cross No :



S.No.	Ekersan No.	Ürün Tanıtımı / Description	Ölçü/Dimension	Miktar/Qty.
1	425238	Geril Getirme Yayı / Return Spring	Ø 3,5 mm	2
2	425239	Geril Getirme Yayı / Return Spring	Ø 4 mm	1

Tip / Application

425214

Fren Ayar Tamir Takimi / Repair Kit Set

Ø 410 SIMPLEX KIT GRUBU

Orjinal No: 93163622 / 93163214

Cross No :



S.No.	Ekersan No.	Ürün Tanıtımı / Description	Ölçü/Dimension	Miktar/Qty.
1	425215	Ayar Civatası / Adjusting Bolt		2
2	425217	Toz Lastiği Silikon / Dust Cover (Silicon)		2
3	425233	Ayar Somunu İnce Diş / Adjusting Nut (Thin Teeth)	49 mm	2
4	425218	Fren Ayar Pistonu / Adjusting Piston		4
5	425213	Ayar Mandalı İnce Diş / Brake Adjusting Latch (Thin Teeth)		2
6	425238	Geril Getirme Yayı / Return Spring	Ø 3,5 mm	1
7	425239	Geril Getirme Yayı / Return Spring	Ø 4 mm	1

Tip / Application

425228

Fren Ayar Piston Takimi Sağ / Adjusting Piston Set Right

Ø 410 SIMPLEX KIT GRUBU

Orjinal No: 93163623

Cross No :



S.No.	Ekersan No.	Ürün Tanıtımı / Description	Ölçü/Dimension	Miktar/Qty.
1	425238	Fren Ayar Pistonu / Adjusting Piston		1
2	425233	Ayar Somunu İnce Diş / Adjusting Nut (Thin Teeth)	49 mm	1
3	425213	Ayar Mandalı İnce Diş / Brake Adjusting Latch (Thin Teeth)		1

Tip / Application

*1. Ø 38.50 X 55.50 MM2. LENGTH: 49.00 MM"

425230

Fren Ayar Kama Takimi / Wedge For Brake Set

ø 410 SIMPLEX KIT GRUBU

Orjinal No: 425230A

Cross No :



S.No.	Ekersan No.	Ürün Tanıtımı / Description	Ölçü/Dimension	Miktar/Qty.
1	425200	Fren Ayar Kaması / Wedge For Brake		2

Tip / Application

425242

Fren Tamir Takimi (Sol) / Brake Repair Kit (Left)

ø 410 SIMPLEX KIT GRUBU

Orjinal No: 93161863

Cross No :



S.No.	Ekersan No.	Ürün Tanıtımı / Description	Ölçü/Dimension	Miktar/Qty.
1	425234	Bağlantı Pistonu Sol / Connection Piston (Left 15°)	15°	1
2	425235	Bağlantı Pistonu Sol / Connection Piston (Left 5°)	5°	1

Tip / Application

425243

Fren Tamir Takimi (Sağ) / Brake Repair Kit (Right)

ø 410 SIMPLEX KIT GRUBU

Orjinal No: 93161864

Cross No :



S.No.	Ekersan No.	Ürün Tanıtımı / Description	Ölçü/Dimension	Miktar/Qty.
1	425236	Bağlantı Pistonu Sağ / Connection Piston (Right 15°)	15°	1
2	425237	Bağlantı Pistonu Sağ / Connection Piston (Right 5°)	5°	1

Tip / Application

425244

Fren Tamir Takimi (Ince Dis) / Brake Repair Kit (Thin Teeth)

ø 410 SIMPLEX KIT GRUBU

Orjinal No:

Cross No :



S.No.	Ekersan No.	Ürün Tanıtımı / Description	Ölçü/Dimension	Miktar/Qty.
1	425232	Ayar Civatası / Adjusting Screw (With Locker)		4
2	425233	Ayar Somunu Ince Dis / Adjusting Nut (Thin Teeth)	49 mm	4
3	425213	Ayar Mandali Ince Dis / Brake Adjusting Latch (Thin Teeth)		4
4	425217	Toz Lastığı Silikon / Dust Cover (Silicon)		4

Tip / Application

2. LENGHT: 49.00 MM

IVECO

425200

Fren Ayar Kaması / Wedge For Brake

ø 410 DUPLEX GRUBU

Orjinal No:

Cross No :

S.No.	Ekersan No.	Ürün Tanıtımı / Description	Ölçü/Dimension	Miktar/Qty.
1	425200	Fren Ayar Kaması / Wedge For Brake		1



Tip / Application

IVECO

425205

Geri Getirme Yaylı / Return Spring

ø 410 DUPLEX GRUBU

Orjinal No:

Cross No :

S.No.	Ekersan No.	Ürün Tanıtımı / Description	Ölçü/Dimension	Miktar/Qty.
1	425205	Geri Getirme Yaylı / Return Spring	ø 4,5 mm	1



Tip / Application

WIRE DIAMETER: 4.50 MMTEL ÇAPİ: 4.50 MM

IVECO

425215

Ayar Civatası / Adjusting Bolt

ø 410 DUPLEX GRUBU

Orjinal No: 42531676 / A22297E9907 / A229758287 / 6C462A005AA

Cross No :

S.No.	Ekersan No.	Ürün Tanıtımı / Description	Ölçü/Dimension	Miktar/Qty.
1	425215	Ayar Civatası / Adjusting Bolt		1



Tip / Application

IVECO

IVECO

425216

Ayar Somunu Kalın Dis / Adjusting Nut (Thick Teeth)

ø 410 DUPLEX GRUBU

Orjinal No:

Cross No :



S.No.	Ekersan No.	Ürün Tanıtımı / Description	Ölçü/Dimension	Miktar/Qty.
1	425216	Ayar Somunu Kalın Dis / Adjusting Nut (Thick Teeth)	49 mm	1

Tip / Application

LENGTH: 49 MMBOY: 49 MM

IVECO

425217

Toz Lastiği (Silikon) / Dust Cover (Silicon)

ø 410 DUPLEX GRUBU

Orjinal No: 42531677

Cross No :



S.No.	Ekersan No.	Ürün Tanıtımı / Description	Ölçü/Dimension	Miktar/Qty.
1	425217	Toz Lastiği Silikon / Dust Cover (Silicon)		1

Tip / Application

IVECO

425218

Fren Ayar Pistonu / Adjusting Piston

ø 410 DUPLEX GRUBU

Orjinal No:

Cross No :



S.No.	Ekersan No.	Ürün Tanıtımı / Description	Ölçü/Dimension	Miktar/Qty.
1	425218	Fren Ayar Pistonu / Adjusting Piston		1

Tip / Application

IVECO

425219

Fren Ayar Mandalı (Kalın Diş) / Brake Adjusting Latch (Thick Teeth)

ø 410 DUPLEX GRUBU

Orjinal No:

Cross No :



S.No.	Ekersan No.	Ürün Tanıtımı / Description	Ölçü/Dimension	Miktar/Qty.
1	425219	Ayar Mandalı Kalın Diş / Brake Adjusting Latch (Thick Teeth)		1

Tip / Application

IVECO

425232

Ayar Civatası / Adjusting Screw (With Locker)

ø 410 DUPLEX GRUBU

Orjinal No:

Cross No :



S.No.	Ekersan No.	Ürün Tanıtımı / Description	Ölçü/Dimension	Miktar/Qty.
1	425232	Ayar Civatası / Adjusting Screw (With Locker)		1

Tip / Application

IVECO

425240

Körük Boğaz Somunu (Uzun) / Locknut (Long)

ø 410 DUPLEX GRUBU

Orjinal No: 93163852

Cross No :

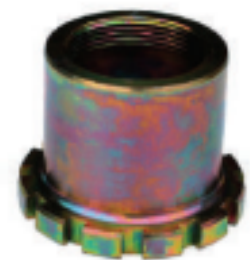

S.No.	Ekersan No.	Ürün Tanıtımı / Description	Ölçü/Dimension	Miktar/Qty.
1	425240	Körük Boğaz Somunu Uzun / Locknut (Long)		1

Tip / Application

IVECO

IVECO

425245

Toz Lastiđi Silikon / Dust Cover (Silicon)

ø 410 DUPLEX GRUBU

Orjinal No:

Cross No :



S.No.	Ekersan No.	Ürün Tanıtımı / Description	Ölçü/Dimension	Miktar/Qty.
1	425245	Toz Lastiđi Silikon / Dust Cover (Silicon)		1

Tip / Application

IVECO

425247

Klavuz Mandal Komple / Guide Screw (Complete)

ø 410 DUPLEX GRUBU

Orjinal No:

Cross No :



S.No.	Ekersan No.	Ürün Tanıtımı / Description	Ölçü/Dimension	Miktar/Qty.
1	425247	Klavuz Mandal Komple / Guide Screw (Complete)		1

Tip / Application

IVECO

425248

Bađlantı Pistonu Sol / Connection Piston (Left)

ø 410 DUPLEX GRUBU

Orjinal No:

Cross No :



S.No.	Ekersan No.	Ürün Tanıtımı / Description	Ölçü/Dimension	Miktar/Qty.
1	425248	Bađlantı Pistonu Sol / Connection Piston (Left)	ø 38,5x71,5 mm	1

Tip / Application

ø 38.50 X 71.50 MM

IVECO

425249

Bağlantı Pistonu Sağ / Connection Piston (Right)

ø 410 DUPLEX GRUBU

Orjinal No:

Cross No :



S.No.	Ekersan No.	Ürün Tanıtımı / Description	Ölçü/Dimension	Miktar/Qty.
1	425249	Bağlantı Pistonu Sağ / Connection Piston (Right)	ø 38,5x71,5 mm	1

Tip / Application

ø 38.50 X 71.50 MM

IVECO

425251

Geri Getirme Yayı / Return Spring

ø 410 DUPLEX GRUBU

Orjinal No:

Cross No :



S.No.	Ekersan No.	Ürün Tanıtımı / Description	Ölçü/Dimension	Miktar/Qty.
1	425251	Geri Getirme Yayı / Return Spring	ø 4 mm	1

Tip / Application

"WIRE DIAMETER: 4.00 MMTEL ÇAPİ: 4.00 MM"

425231

Fren Ayar Tamir Takimi / Repair Kit Set

ø 410 DUPLEX KIT GRUBU

Orjinal No: 42536107

Cross No :



S.No.	Ekersan No.	Ürün Tanıtımı / Description	Ölçü/Dimension	Miktar/Qty.
1	425218	Fren Ayar Pistonu / Adjusting Piston		2
2	425236	Ayar Somunu Kalın Dis / Adjusting Nut (THick Teeth)	49 mm	2
3	425219	Ayar Mandali Kalın Dis / Brake Adjusting Latch (Thick Teeth)		2
4	425217	Toz Lastığı Silikon / Dust Cover (Silicon)		2
5	425232	Ayar Civatası / Adjusting Screw (With Locker)		2
6	425205	Geril Getirme Yaylı / Return Spring	ø 4,5 mm	2

Tip / Application

*1. Ø. 38.50 X 55.50 MM2. LENGHT: 49.00 MM"

425253

Fren Tamir Takimi / Brake Repair Kit

ø 410 DUPLEX KIT GRUBU

Orjinal No:

Cross No :



S.No.	Ekersan No.	Ürün Tanıtımı / Description	Ölçü/Dimension	Miktar/Qty.
1	425235	Ayar Civatası / Adjusting Bolt		2
2	425217	Toz Lastığı Silikon / Dust Cover (Silicon)		2
3	425236	Ayar Somunu Kalın Dis / Adjusting Nut (THick Teeth)	49 mm	2
4	425218	Fren Ayar Pistonu / Adjusting Piston		2
5	425219	Ayar Mandali Kalın Dis / Brake Adjusting Latch (Thick Teeth)		2
6	425251	Geril Getirme Yaylı / Return Spring	ø 4 mm	1
7	425205	Geril Getirme Yaylı / Return Spring	ø 4,5 mm	1

Tip / Application

425254

Fren Tamir Takimi (Sag) / Brake Repair Kit (Right)

ø 410 DUPLEX KIT GRUBU

Orjinal No: 42537365

Cross No :



S.No.	Ekersan No.	Ürün Tanıtımı / Description	Ölçü/Dimension	Miktar/Qty.
1	425249	Bağlantı Pistonu Sag / Connection Piston (Right)	ø 38,5x71,5 mm	2
2	425245	Toz Lastığı Silikon / Dust Cover (Silicon)		2
3	425247	Klavuz Mandal Komple / Guide Screw (Completo)		2

Tip / Application

1. Ø. 38.50 X 71.50 MM

425255

Fren Tamir Takimi (Sol) / Brake Repair Kit (Left)

ø 410 DUPLEX KIT GRUBU

Orjinal No: 42537305

Cross No :



S.No.	Ekersan No.	Ürün Tanıtımı / Description	Ölçü/Dimension	Miktar/Qty.
1	425248	Bağlantı Pistonu Sol / Connection Piston (Left)	ø 38,5x71,5 mm	2
2	425245	Toz Lastığı Silikon / Dust Cover (Silicon)		2
3	425247	Klavuz Mandal Komple / Guide Screw (Complete)		2

Tip / Application

1. ø. 38.50 X 71.50 MM

425256

Fren Tamir Takimi (Kalın Dis) / Brake Repair Kit (Thick Teeth)

ø 410 DUPLEX KIT GRUBU

Orjinal No: 42536395

Cross No :

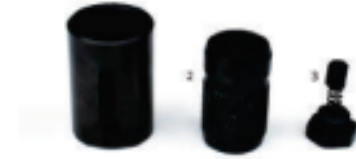

S.No.	Ekersan No.	Ürün Tanıtımı / Description	Ölçü/Dimension	Miktar/Qty.
1	425218	Fren Ayar Pistonu / Adjusting Piston		1
2	425216	Ayar Somunu Kalın Dis / Adjusting Nut (Thick Teeth)	49 mm	1
3	425219	Ayar Mandal Kalın Dis / Brake Adjusting Latch (Thick Teeth)		1

Tip / Application

"1. ø. 38.50 X 55.50 MM2. LENGTH: 49.00 MM"

425257

Fren Tamir Takimi (Kalın Dis) / Brake Repair Kit (Thick Teeth)

ø 410 DUPLEX KIT GRUBU

Orjinal No: 2996557

Cross No :

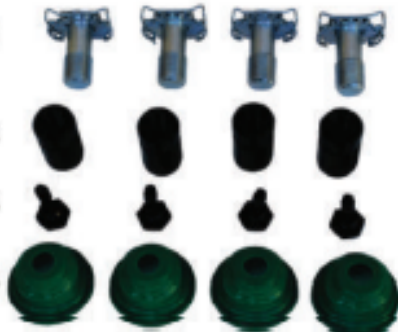

S.No.	Ekersan No.	Ürün Tanıtımı / Description	Ölçü/Dimension	Miktar/Qty.
1	425232	Ayar Divotası / Adjusting Screw (With Locker)		4
2	425216	Ayar Somunu Kalın Dis / Adjusting Nut (Thick Teeth)	49 mm	4
3	425219	Ayar Mandal Kalın Dis / Brake Adjusting Latch (Thick Teeth)		4
4	425217	Toz Lastığı Silikon / Dust Cover (Silicon)		4

Tip / Application

2. LENGTH: 49.00 MM

IVECO

425221

Fren Ayar Piston Üstü / Adjusting Piston Up

ø 410 PERROT GRUBU

Orjinal No:

Cross No :



S.No.	Ekersan No.	Ürün Tanıtımı / Description	Ölçü/Dimension	Miktar/Qty.
1	425221	Fren Ayar Piston Üstü / Adjusting Piston Up	ø 38x21 mm	1

Tip / Application

ø 38.00 X 21.00 MM

IVECO

425222

Fren Ayar Piston Altı / Adjusting Piston Down

ø 410 PERROT GRUBU

Orjinal No:

Cross No :



S.No.	Ekersan No.	Ürün Tanıtımı / Description	Ölçü/Dimension	Miktar/Qty.
1	425222	Fren Ayar Piston Altı / Adjusting Piston Down		1

Tip / Application

ø 32.00 X 18.30 MM

IVECO

425224

Toz Lastiği (Silikon) / Dust Cover (Silicon)

ø 410 PERROT GRUBU

Orjinal No:

Cross No :



S.No.	Ekersan No.	Ürün Tanıtımı / Description	Ölçü/Dimension	Miktar/Qty.
1	425224	Toz Lastiği Silikon / Dust Cover (Silicon)		1

Tip / Application

IVECO

425225

Fren Ayar Pistonu / Adjusting Piston

Ø 410 PERROT GRUBU

Orjinal No:

Cross No :



S.No.	Ekersan No.	Ürün Tanıtımı / Description	Ölçü/Dimension	Miktar/Qty.
1	425225	Fren Ayar Pistonu / Adjusting Piston	Ø 43,9x61 mm	1

Tip / Application

Ø 43.90 X 61.00 MM

IVECO

425227

Fren Ayar Mandalı / Brake Adjusting Latch

Ø 410 PERROT GRUBU

Orjinal No:

Cross No :



S.No.	Ekersan No.	Ürün Tanıtımı / Description	Ölçü/Dimension	Miktar/Qty.
1	425227	Fren Ayar Mandalı / Brake Adjusting Latch		1

Tip / Application

IVECO

425258

Ayar Mekanizma Seti / Adjusting Mechanism Set

Ø 410 PERROT GRUBU

Orjinal No:

Cross No :



S.No.	Ekersan No.	Ürün Tanıtımı / Description	Ölçü/Dimension	Miktar/Qty.
1	42531A	Ayar Mekanizması / Adjusting Mechanism		1
2	425227	Fren Ayar Mandalı / Brake Adjusting Latch		1

Tip / Application

Ø 43.90 X 61.00 MM

IVECO

425259

Ayar Civatası / Adjusting Bolt

ø 410 PERROT GRUBU

Orjinal No:

Cross No :



S.No.	Ekersan No.	Ürün Tanıtımı / Description	Ölçü/Dimension	Miktar/Qty.
1	425259	Ayar Civatası / Adjusting Bolt		1

Tip / Application

IVECO

425260

Raynel & Yay / Shim & Spring

ø 410 PERROT GRUBU

Orjinal No:

Cross No :



S.No.	Ekersan No.	Ürün Tanıtımı / Description	Ölçü/Dimension	Miktar/Qty.
1	425333	Raynel/		1
2	425332	Yay Oval / Spring	ø 31 mm	1

Tip / Application

SPRING : ø 31.00 MM (OVAL)YAY : ø 31.00 MM (OVAL)

IVECO

425261

Geri Getirme Yay / Return Spring

ø 410 PERROT GRUBU

Orjinal No: 602308

Cross No :



S.No.	Ekersan No.	Ürün Tanıtımı / Description	Ölçü/Dimension	Miktar/Qty.
1	425261	Geri Getirme Yay / Return Spring		1

Tip / Application

WIRE DIAMETER: 3.50 MMTEL ÇAP: 3.50 MM

IVECO

425262

Geri Getirme Yayı / Return Spring

ø 410 PERROT GRUBU

Orjinal No: 8121307

Cross No :

S.No.	Ekersan No.	Ürün Tanıtımı / Description	Ölçü/Dimension	Miktar/Qty.
1	425262	Geri Getirme Yayısı / Return Spring		1



Tip / Application

"WIRE DIAMETER: 3.50 MMTEL ÇAPİ: 3.50 MM"

425316

Fren Ayar Kamasi / Wedge For Brake

ø 410 PERROT GRUBU

Orjinal No:

Cross No :

S.No.	Ekersan No.	Ürün Tanıtımı / Description	Ölçü/Dimension	Miktar/Qty.
1	425316	Fren Ayar Kamasi / Wedge For Brake		1



Tip / Application

IVECO

425220

Fren Ayar Tamir Takimi / Repair Kit Set

ø 410 PERROT KIT GRUBU

Orjinal No:

Cross No :



S.No.	Ekersan No.	Ürün Tanıtımı / Description	Ölçü/Dimension	Miktar/Qty.
1	425334	Ayar Mekanizması / Adjusting Mechanism		2
2	425227	Fren Ayar Mandalı / Brake Adjusting Latch		2
3	425224	Toz Lastığı Silikon / Dust Cover (Silicon)		2

Tip / Application

1. Ø 43.90 X 61.00 MM

IVECO

IVECO

425263

Fren Tamir Takimi / Brake Repair Kit

ø 410 PERROT KIT GRUBU

Orjinal No: 93163256

Cross No :



S.No.	Ekersan No.	Ürün Tanıtımı / Description	Ölçü/Dimension	Miktar/Qty.
1	425221	Fren Ayar Piston Üstü / Adjusting Piston Up	Ø 38x21 mm	2
2	425222	Fren Ayar Piston Altı / Adjusting Piston Down		2
3	525227	Fren Ayar Mandalı / Brake Adjusting Latch		2

Tip / Application

1. Ø 38.00 X 21.00 MM2. Ø 32.00 X 18.30 MM

IVECO

IVECO

425264

Fren Tamir Takimi / Brake Repair Kit

ø 410 PERROT KIT GRUBU

Orjinal No: 93163768

Cross No :



S.No.	Ekersan No.	Ürün Tanıtımı / Description	Ölçü/Dimension	Miktar/Qty.
1	425225	Fren Ayar Pistonu / Adjusting Piston	Ø 43,9x61 mm	2
2	425336	Fren Ayar Kamaşı / Wedge For Brake		1

Tip / Application

1. Ø 43.90 X 61.00 MM

425265

Fren Tamir Takimi / Brake Repair Kit

ø 410 PERROT KIT GRUBU

Orjinal No:

Cross No :

S.No.	Ekersan No.	Ürün Tanıtımı / Description	Ölçü/Dimension	Miktar/Qty.
1	425314	Ayar Mekanizması / Adjusting Mechanism		2
2	425316	Fren Ayar Kamasi / Wedge For Brake		1
3	425224	Toz Lastığı Silikon / Dust Cover (Silicon)		2
4	425227	Fren Ayar Mandalı / Brake Adjusting Latch		2
5	425261	Gerilme Yay / Return Spring		1
6	425262	Gerilme Yay / Return Spring		1



Tip / Application

1. Ø 43.90 X 61.00 MM5. Ø 3.50 MM6. Ø 3.50 MM

425266

Fren Tamir Takimi / Brake Repair Kit

ø 410 PERROT KIT GRUBU

Orjinal No: 93161257

Cross No :

S.No.	Ekersan No.	Ürün Tanıtımı / Description	Ölçü/Dimension	Miktar/Qty.
1	425224	Toz Lastığı Silikon / Dust Cover (Silicon)		2
2	425260	Raynal & Yay / Shim & Spring		2



Tip / Application

425267

Fren Ayar Tamir Takımı / Brake Adjusting Repair Kit

ø 410 PERROT KIT GRUBU

Orjinal No: 93161254

Cross No :

S.No.	Ekersan No.	Ürün Tanıtımı / Description	Ölçü/Dimension	Miktar/Qty.
1	425224_2	Toz Lastığı (Silikon) / Dust Cover (Silicon)		2
2	425259	Ayar Çivisi / Adjusting Bolt		2
3	425260	Raynal & Yay / Shim & Spring		2



Tip / Application

IVECO

425201

Fren Ayar Kamasi / Wedge For Brake

Ø 360 PERROT GRUBU

Orjinal No:

Cross No :

S.No.	Ekersan No.	Ürün Tanıtımı / Description	Ölçü/Dimension	Miktar/Qty.
1	425201	Fren Ayar Kamasi / Wedge For Brake		1



Tip / Application

IVECO

425222

Fren Ayar Piston Altı / Adjusting Piston Down

Ø 360 PERROT GRUBU

Orjinal No:

Cross No :

S.No.	Ekersan No.	Ürün Tanıtımı / Description	Ölçü/Dimension	Miktar/Qty.
1	425222	Fren Ayar Piston Altı / Adjusting Piston Down		1



Tip / Application

Ø 32.00 X 18.30 MM

IVECO

425224

Toz Lastiği (Silikon) / Dust Cover (Silicon)

Ø 360 PERROT GRUBU

Orjinal No:

Cross No :

S.No.	Ekersan No.	Ürün Tanıtımı / Description	Ölçü/Dimension	Miktar/Qty.
1	425224	Toz Lastiği Silikon / Dust Cover (Silicon)		1



Tip / Application

IVECO

425227

Fren Ayar Mandalı / Brake Adjusting Latch

ø 360 PERROT GRUBU

Orjinal No:

Cross No :

S.No.	Ekersan No.	Ürün Tanıtımı / Description	Ölçü/Dimension	Miktar/Qty.
1	425227	Fren Ayar Mandalı / Brake Adjusting Latch		1



Tip / Application

IVECO

425259

Ayar Civatası / Adjusting Bolt

ø 360 PERROT GRUBU

Orjinal No:

Cross No :

S.No.	Ekersan No.	Ürün Tanıtımı / Description	Ölçü/Dimension	Miktar/Qty.
1	425259	Ayar Civatası / Adjusting Bolt		1



Tip / Application

IVECO

425260

Raynel & Yay / Shim & Spring

ø 360 PERROT GRUBU

Orjinal No:

Cross No :

S.No.	Ekersan No.	Ürün Tanıtımı / Description	Ölçü/Dimension	Miktar/Qty.
1	425313	Raynel /		1
2	425312	Yay Oval / Spring	ø 31 mm	1



Tip / Application

425261

Geri Getirme Yayı / Return Spring

Ø 360 PERROT GRUBU

Orjinal No: 6023300

Cross No :

S.No.	Ekersan No.	Ürün Tanıtımı / Description	Ölçü/Dimension	Miktar/Qty.
1	425261	Geri Getirme Yayı / Return Spring		1



Tip / Application

WIRE DIAMETER: 3.50 MMETEL ÇAPİ: 3.50 MM

425262

Geri Getirme Yayı / Return Spring

Ø 360 PERROT GRUBU

Orjinal No: 6023307

Cross No :

S.No.	Ekersan No.	Ürün Tanıtımı / Description	Ölçü/Dimension	Miktar/Qty.
1	425262	Geri Getirme Yayı / Return Spring		1



Tip / Application

WIRE DIAMETER: 3.50 MMETEL ÇAPİ: 3.50 MM

425268

Ayar Mekanizması / Adjusting Mechanism

Ø 360 PERROT GRUBU

Orjinal No:

Cross No :

S.No.	Ekersan No.	Ürün Tanıtımı / Description	Ölçü/Dimension	Miktar/Qty.
1	425315	Ayar Mekanizması / Adjusting Mechanism		1
2	425227	Fren Ayar Mandalı / Brake Adjusting Latch		1



Tip / Application

Ø 41.50 X 49.00 MM

IVECO

425270

Fren Ayar Pistonu / Adjusting Piston

Ø 360 PERROT GRUBU

Orjinal No:

Cross No :



S.No.	Ekersan No.	Ürün Tanıtımı / Description	Ölçü/Dimension	Miktar/Qty.
1	425270	Fren Ayar Pistonu / Adjusting Piston	Ø 41,5x49 mm	1

Tip / Application

Ø 41.50 X 49.00 MM

IVECO

425277

Fren Ayar Piston Üstü / Adjusting Piston Up

Ø 360 PERROT GRUBU

Orjinal No:

Cross No :



S.No.	Ekersan No.	Ürün Tanıtımı / Description	Ölçü/Dimension	Miktar/Qty.
1	425277	Fren Ayar Piston Üstü / Adjusting Piston Up	Ø 36x18 mm	1

Tip / Application

Ø 36.00 X 18.00 MM

IVECO

425308

Fren Ayar Piston Üstü / Adjusting Piston Up

Ø 360 PERROT GRUBU

Orjinal No:

Cross No :



S.No.	Ekersan No.	Ürün Tanıtımı / Description	Ölçü/Dimension	Miktar/Qty.
1	425308	Fren Ayar Piston Üstü / Adjusting Piston Up	Ø 36x21,5 mm	1

Tip / Application

Ø 38.00 X 21.00 MM

425223

Fren Ayar Piston Takimi / Adjusting Piston Set

Ø 360 PERROT KIT GRUBU

Orjinal No: 8124815

Cross No :

S.No.	Ekersan No.	Ürün Tanıtımı / Description	Ölçü/Dimension	Miktar/Qty.
1	425308	Fren Ayar Piston Üstü / Adjusting Piston Up	Ø 36x21,5 mm	2
2	425222	Fren Ayar Piston Altı / Adjusting Piston Down		2
3	425227	Fren Ayar Mandalı / Brake Adjusting Latch		2



Tip / Application

1. Ø 36.00 X 21.50 MM2. Ø 32.00 X 18.30 MM

425267

Fren Ayar Tamir Takımı / Brake Adjusting Repair Kit

Ø 360 PERROT KIT GRUBU

Orjinal No: 9386254

Cross No :

S.No.	Ekersan No.	Ürün Tanıtımı / Description	Ölçü/Dimension	Miktar/Qty.
1	425224_1	Toz Lastiği (Silikon) / Dust Cover (Silicon)		2
2	425259	Ayar Civatası / Adjusting Bolt		1

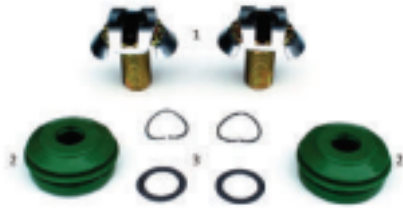

Tip / Application

425279

Fren Ayar Tamir Takımı / Brake Adjusting Repair Kit

Ø 360 PERROT KIT GRUBU

Orjinal No: 9386267

Cross No :

S.No.	Ekersan No.	Ürün Tanıtımı / Description	Ölçü/Dimension	Miktar/Qty.
1	425201	Fren Ayar Kaması / Wedge For Brake		1



Tip / Application

1. Ø 41.50 X 49.00 MM

425280

Fren Tamir Takimi / Brake Repair Kit

Ø 360 PERROT KIT GRUBU

Orjinal No:

Cross No :



S.No.	Ekersan No.	Ürün Tanıtımı / Description	Ölçü/Dimension	Miktar/Qty.
1	425201	Fren Ayar Kamasi / Wedge For Brake		1
2	425224	Toz Lastığı Silikon / Dust Cover (Silicon)		2
3	425261	Geril Getirme Yaylı / Return Spring		5
4	425262	Geril Getirme Yaylı / Return Spring		6

Tip / Application

1. Ø 41.50 X 49.00 MM5. Ø 3.50 MM6. Ø 3.50 MM

425281

Fren Tamir Takimi / Brake Repair Kit

Ø 360 PERROT KIT GRUBU

Orjinal No: 93161268

Cross No :



S.No.	Ekersan No.	Ürün Tanıtımı / Description	Ölçü/Dimension	Miktar/Qty.
1	425222	Fren Ayar Piston Aşağı / Adjusting Piston Down		2
2	425227	Fren Ayar Mandali / Brake Adjusting Latch		2

Tip / Application

1. Ø 36.00 X 18.00 MM2. Ø 32.00 X 18.30 MM

425283

Fren Ayar Tamir Takimi / Brake Adjusting Repair Kit

Ø 360 PERROT KIT GRUBU

Orjinal No:

Cross No :



S.No.	Ekersan No.	Ürün Tanıtımı / Description	Ölçü/Dimension	Miktar/Qty.
1	425315	Ayar Mekanizması / Adjusting Mechanism		2
2	425224	Toz Lastığı Silikon / Dust Cover (Silicon)		2

Tip / Application

1. Ø 41.50 X 49.00 MM

IVECO

425208

Ayar Somunu İnce Dis / Adjusting Nut (Thin Teeth)

Ø 360 DUPLEX GRUBU

Orjinal No:

Cross No :



S.No.	Ekersan No.	Ürün Tanıtımı / Description	Ölçü/Dimension	Miktar/Qty.
1	425208	Ayar Somunu İnce Dis / Adjusting Nut (Thin Teeth)	41,5 mm	1

Tip / Application

LENGHT 41.50 MMBOY: 41.50 MM

IVECO

425212

Fren Ayar Pistonu / Adjusting Piston

Ø 360 DUPLEX GRUBU

Orjinal No:

Cross No :



S.No.	Ekersan No.	Ürün Tanıtımı / Description	Ölçü/Dimension	Miktar/Qty.
1	425212	Fren Ayar Pistonu / Adjusting Piston	Ø 38,5x48,5 mm	1

Tip / Application

Ø 38.50 X 48.50 MM

IVECO

425217

Toz Lastiği (Silikon) / Dust Cover (Silicon)

Ø 360 DUPLEX GRUBU

Orjinal No: 42531677

Cross No :



S.No.	Ekersan No.	Ürün Tanıtımı / Description	Ölçü/Dimension	Miktar/Qty.
1	425217	Toz Lastiği Silikon / Dust Cover (Silicon)		1

Tip / Application

IVECO

IVECO

425219

Fren Ayar Mandalı (Kalın Diş) / Brake Adjusting Latch (Thick Teeth)

Ø 360 DUPLEX GRUBU

Orjinal No:

Cross No :



S.No.	Ekersan No.	Ürün Tanıtımı / Description	Ölçü/Dimension	Miktar/Qty.
1	425219	Ayar Mandalı Kalın Diş / Brake Adjusting Latch (Thick Teeth)		1

Tip / Application

IVECO

425226

Fren Ayar Vidası Kısa / Adjusting Screw (Short)

Ø 360 DUPLEX GRUBU

Orjinal No: 42530071

Cross No :



S.No.	Ekersan No.	Ürün Tanıtımı / Description	Ölçü/Dimension	Miktar/Qty.
1	425226	Fren Ayar Vidası Kısa / Adjusting Screw (Short)		1

Tip / Application

IVECO

425285

Ayar Somunu Kalın Diş / Adjusting Nut (Thick Teeth)

Ø 360 DUPLEX GRUBU

Orjinal No:

Cross No :



S.No.	Ekersan No.	Ürün Tanıtımı / Description	Ölçü/Dimension	Miktar/Qty.
1	425285	Ayar Somunu Kalın Diş / Adjusting Nut (Thick Teeth)	41,5 mm	1

Tip / Application

"LENGTH: 41.50 MMBOY: 41.50 MM"

IVECO

425287

ø 360 DUPLEX GRUBU

Geri Getirme Yayı / Return Spring

Orjinal No:

Cross No :

S.No.	Ekersan No.	Ürün Tanıtımı / Description	Ölçü/Dimension	Miktar/Qty.
1	425287	Geri Getirme Yayı / Return Spring	ø 3,8 mm	1



Tip / Application

WIRE DIAMETER: 3.80 MMTL ÇAPİ: 3.80 MM

IVECO

425288

ø 360 DUPLEX GRUBU

Geri Getirme Yayı / Return Spring

Orjinal No:

Cross No :

S.No.	Ekersan No.	Ürün Tanıtımı / Description	Ölçü/Dimension	Miktar/Qty.
1	425288	Geri Getirme Yayı / Return Spring	ø 4 mm	1



Tip / Application

WIRE DIAMETER: 4.00 MMTL ÇAPİ: 4.00 MM

425289

Fren Tamir Takimi / Brake Repair Kit

ø 360 DUPLEX KIT GRUBU

Orjinal No: 42538085

Cross No :



S.No.	Ekersan No.	Ürün Tanıtımı / Description	Ölçü/Dimension	Miktar/Qty.
1	425226	Fren Ayar Vidası Kısa / Adjusting Screw (Short)		2
2	425217	Toz Lastığı Silikon / Dust Cover (Silicon)		2
3	425285	Ayar Somunu Kalın Diş / Adjusting Nut (Thick Teeth)	41,5 mm	2
4	425212	Fren Ayar Pistonu / Adjusting Piston	ø 38,5x48,5 mm	2
5	425219	Ayar Mondalı Kalın Diş / Brake Adjusting Latch (Thick Teeth)		5
6	425287	Geri Getirme Yaylı / Return Spring	ø 3,8 mm	6
7	425288	Geri Getirme Yaylı / Return Spring	ø 4 mm	1

Tip / Application

425202

Fren Ayar Kamasi / Wedge For Brake

ø 381 - ø 394 DUPLEX GRUBU

Orjinal No: 7880407-K / 42480062

Cross No :



Tip / Application

S.No.	Ekersan No.	Ürün Tanıtımı / Description	Ölçü/Dimension	Miktar/Qty.
1	425202	Fren Ayar Kamasi / Wedge For Brake		1

425203

Fren Ayar Kamasi / Wedge For Brake

ø 381 - ø 394 DUPLEX GRUBU

Orjinal No:

Cross No :



Tip / Application

S.No.	Ekersan No.	Ürün Tanıtımı / Description	Ölçü/Dimension	Miktar/Qty.
1	425203	Fren Ayar Kamasi / Wedge For Brake		1

425207

Fren Ayar Vidasi / Adjusting Screw

ø 381 - ø 394 DUPLEX GRUBU

Orjinal No: 42480059 / A364002 / A2257L3158

Cross No :



Tip / Application

S.No.	Ekersan No.	Ürün Tanıtımı / Description	Ölçü/Dimension	Miktar/Qty.
1	425207	Fren Ayar Vidasi / Adjusting Screw		1

IVECO

425209

Fren Ayar Toz Keçesi / Dust Cover

ø 381 - ø 394 DUPLEX GRUBU

Orjinal No:

Cross No :



S.No.	Ekersan No.	Ürün Tanıtımı / Description	Ölçü/Dimension	Miktar/Qty.
1	425209	Fren Ayar Toz Keçesi / Dust Cover		1

Tip / Application

IVECO

425210

Toz Lastığı Silikon / Dust Cover (Silicon)

ø 381 - ø 394 DUPLEX GRUBU

Orjinal No:

Cross No :



S.No.	Ekersan No.	Ürün Tanıtımı / Description	Ölçü/Dimension	Miktar/Qty.
1	425210	Toz Lastığı Silikon / Dust Cover (Silicon)		1

Tip / Application

IVECO

425290

Ayar Somunu İnce Dis / Adjusting Nut (Thin Teeth)

ø 381 - ø 394 DUPLEX GRUBU

Orjinal No:

Cross No :



S.No.	Ekersan No.	Ürün Tanıtımı / Description	Ölçü/Dimension	Miktar/Qty.
1	425290	Ayar Somunu İnce Dis / Adjusting Nut (Thin Teeth)	36,7 mm	1

Tip / Application

"LENGHT: 36.70 MMBOY: 36.70 MM"

425292

Geri Getirme Yayı / Return Spring

Ø 381 - Ø 394 DUPLEX GRUBU

Orjinal No:

Cross No :



S.No.	Ekersan No.	Ürün Tanıtımı / Description	Ölçü/Dimension	Miktar/Qty.
1	425292	Geri Getirme Yayı / Return Spring	Ø 3,5 mm	1

Tip / Application

WIRE DIAMETER: 3.50 MMTEL ÇAPİ: 3.50 MM

425293

Fren Ayar Pistonu / Adjusting Piston

Ø 381 - Ø 394 DUPLEX GRUBU

Orjinal No:

Cross No :



S.No.	Ekersan No.	Ürün Tanıtımı / Description	Ölçü/Dimension	Miktar/Qty.
1	425293	Fren Ayar Pistonu / Adjusting Piston	Ø 35x49 mm	1

Tip / Application

Ø 35.00 X 49.00 MM

425294

Bağlantı Pistonu Sol / Connection Piston (Left)

Ø 381 - Ø 394 DUPLEX GRUBU

Orjinal No: 7984217

Cross No :



S.No.	Ekersan No.	Ürün Tanıtımı / Description	Ölçü/Dimension	Miktar/Qty.
1	425294	Bağlantı Pistonu Sol / Connection Piston (Left)	Ø 35x70 mm	1

Tip / Application

Ø 35.00 X 70.00 MM

425295

Bağlantı Pistonu Sol / Connection Piston (Right)

Ø 381 - Ø 394 DUPLEX GRUBU

Orjinal No: 7984235

Cross No :



S.No.	Ekersan No.	Ürün Tanıtımı / Description	Ölçü/Dimension	Miktar/Qty.
1	425295	Bağlantı Pistonu Sol / Connection Piston (Right)	Ø 35x70 mm	1

Tip / Application

Ø 35.00 X 70.00 MM

425296

Kıvaz Mandal Komple / Glide Screw (Complete)

Ø 381 - Ø 394 DUPLEX GRUBU

Orjinal No:

Cross No :



S.No.	Ekersan No.	Ürün Tanıtımı / Description	Ölçü/Dimension	Miktar/Qty.
1	425296	Kıvaz Mandal Komple / Glide Screw (Complete)		1

Tip / Application

425297

Baskı Kelepçe Seti / Pressure Clip Set

Ø 381 - Ø 394 DUPLEX GRUBU

Orjinal No: 42488454

Cross No :



S.No.	Ekersan No.	Ürün Tanıtımı / Description	Ölçü/Dimension	Miktar/Qty.
1	425310	Baskı Kelepçesi / Pressure Clip		1
2	425311	Civata Seti /		1

Tip / Application

IVECO

425298

Körük Bogaz Somunu Kısa / Locknut (Short)

ø 381 - ø 394 DUPLEX GRUBU

Orjinal No:

Cross No :

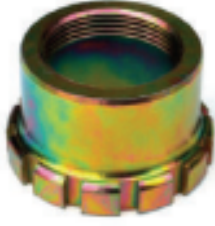

S.No.	Ekersan No.	Ürün Tanıtımı / Description	Ölçü/Dimension	Miktar/Qty.
1	425298	Körük Bogaz Somunu Kısa / Locknut (Short)		1

Tip / Application

IVECO

425299

Körük Bogaz Somunu Uzun / Locknut (Long)

ø 381 - ø 394 DUPLEX GRUBU

Orjinal No:

Cross No :



S.No.	Ekersan No.	Ürün Tanıtımı / Description	Ölçü/Dimension	Miktar/Qty.
1	425299	Körük Bogaz Somunu Uzun / Locknut (Long)		1

Tip / Application

IVECO

425300

Körük Bogaz Somunu / Locknut

ø 381 - ø 394 DUPLEX GRUBU

Orjinal No: 4796032

Cross No :



S.No.	Ekersan No.	Ürün Tanıtımı / Description	Ölçü/Dimension	Miktar/Qty.
1	425300	Körük Bogaz Somunu / Locknut		1

Tip / Application

IVECO

425307

Ayar Mandali Ince Dis / Brake Adjusting Latch (Thin Teeth)

ø 381 - ø 394 DUPLEX GRUBU

Original No:

Cross No :



S.No.	Ekersan No.	Ürün Tanıtımı / Description	Ölçü/Dimension	Miktar/Qty.
1	425307	Ayar Mandali Ince Dis / Brake Adjusting Latch (Thin Teeth)		1

Tip / Application

425206

Fren Ayar Tamir Takimi (Ince Dis) / Brake Repair Kit (Thin Teeth)

ø 381 - ø 394 DUPLEX KİT GRUBU

Orjinal No: 4245050

Cross No :



S.No.	Ekersan No.	Ürün Tanıtımı / Description	Ölçü/Dimension	Miktar/Qty.
1	425207	Fren Ayar Vidası / Adjusting Screw		2
2	425230	Toz Lastığı Silikon / Dust Cover (Silicon)		2
3	425290	Ayar Somunu Ince Dis / Adjusting Nut (Thin Teeth)	36,7 mm	2
4	425293	Fren Ayar Pistonu / Adjusting Piston	ø 35x49 mm	2
5	425307	Ayar Mandalı Ince Dis / Brake Adjusting Latch (Thin Teeth)		2
6	425292	Geri Getirme Yaylı / Return Spring	ø 3,5 mm	2

Tip / Application

3. LENGTH: 36.70 MM4. ø 35.00 X 49.00 MM6. ø 3.50 MM

425211

Toz Keçe Takimi / Dust Seal Set

ø 381 - ø 394 DUPLEX KİT GRUBU

Orjinal No: 7980408

Cross No :



S.No.	Ekersan No.	Ürün Tanıtımı / Description	Ölçü/Dimension	Miktar/Qty.
1	425209	Fren Ayar Toz Keçesi / Dust Cover		2
2	425230	Toz Lastığı Silikon / Dust Cover (Silicon)		2

Tip / Application

425229

Fren Ayar Piston Takimi / Adjusting Piston Set

ø 381 - ø 394 DUPLEX KİT GRUBU

Orjinal No: 4245054

Cross No :



S.No.	Ekersan No.	Ürün Tanıtımı / Description	Ölçü/Dimension	Miktar/Qty.
1	425293	Fren Ayar Pistonu / Adjusting Piston	ø 35x49 mm	1
2	425290	Ayar Somunu Ince Dis / Adjusting Nut (Thin Teeth)	36,7 mm	1
3	425307	Ayar Mandalı Ince Dis / Brake Adjusting Latch (Thin Teeth)		1

Tip / Application

1. ø 35.00 X 49.00 MM2. LENGTH: 36.70 MM

425301

Fren Ayar Kama Takimi / Wedge For Brake Set

ø 381 - ø 394 DUPLEX KİT GRUBU

Orjinal No: 7900405

Cross No :

S.No.	Ekersan No.	Ürün Tanıtımı / Description	Ölçü/Dimension	Miktar/Qty.
1	425202	Fren Ayar Kamasi / Wedge For Brake		2



Tip / Application

425302

Fren Tamir Takimi (Sol) / Brake Repair Kit (Left)

ø 381 - ø 394 DUPLEX KİT GRUBU

Orjinal No: 7900405

Cross No :

S.No.	Ekersan No.	Ürün Tanıtımı / Description	Ölçü/Dimension	Miktar/Qty.
1	425294	Bağlantı Pistonu Sol / Connection Piston (Left)	ø 35x70 mm	2
2	425209	Fren Ayar Toz Kaçesi / Dust Cover		2
3	425296	Klavuz Mandal Komple / Guide Screw (Complete)		2

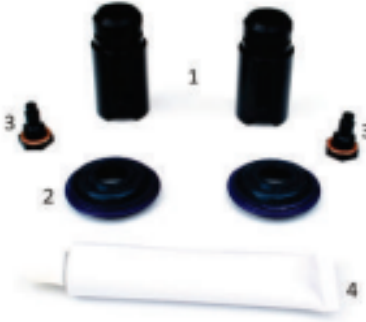

Tip / Application

1. ø 35.00 X 49.00 MM

425303

Fren Tamir Takimi (Sağ) / Brake Repair Kit (Right)

ø 381 - ø 394 DUPLEX KİT GRUBU

Orjinal No: 7900405

Cross No :

S.No.	Ekersan No.	Ürün Tanıtımı / Description	Ölçü/Dimension	Miktar/Qty.
1	425295	Bağlantı Pistonu Sağ / Connection Piston (Right)	ø 35x70 mm	2
2	425209	Fren Ayar Toz Kaçesi / Dust Cover		2
3	425296	Klavuz Mandal Komple / Guide Screw (Complete)		2



Tip / Application

1. ø 35.00 X 49.00 MM2. LENGTH: 36.70 MM

SAF

SAF

421114

Kaliper Tamir Takimi Komple (Ø 74 mm) / Caliper Repair Kit Full (Ø 74 mm)

KIT

Orjinal No:

Cross No :



S.No.	Ekersan No.	Ürün Tanıtımı / Description	Ölçü/Dimension	Miktar/Qty.
1	423003	Pabuđu Lastik / Trust Part With Bellow	Ø 74,00 mm	2
2	423004	Toz Lastigi / Shaft Body Dust Rubber	Ø 74,00 mm	2
3	426001	Metal Buç / Tappet Bush	Ø 18x16x10 mm	2
4	421130	Kaliper Dürbün Takimi / Caliper Bridge Assembly - Set		1
5	421124	Masura Bilya Yatagi / Caliper Lever (Angel: 0°)	Açı / Angel : 0°	1
6	423546	Kaliper Masura Bilya / Caliper Roller Bearing		2
7	421139	Mekanizma Zinciri / Caliper Calibration Shaft Chain (29 Links)		1
8	421127	Ayar Mekanizması Yayli / Caliper Adjusting Mechanism (With Spring)		1
9	421128	Kaliper Mekanizması / Caliper Adjusting Mechanism Shaft		1

Tip / Application

ALL SB7... SERIES

SAF

421115

Kaliper Tamir Takimi Komple (Ø 74 mm) / Caliper Repair Kit Full (Ø 74 mm)

KIT

Orjinal No:

Cross No :



S.No.	Ekersan No.	Ürün Tanıtımı / Description	Ölçü/Dimension	Miktar/Qty.
1	423003	Pabuđu Lastik / Trust Part With Bellow	Ø 74,00 mm	2
2	423004	Toz Lastigi / Shaft Body Dust Rubber	Ø 74,00 mm	2
3	426001	Metal Buç / Tappet Bush	Ø 18x16x10 mm	2
4	421130	Kaliper Dürbün Takimi / Caliper Bridge Assembly - Set		1
5	421123	Masura Bilya Yatagi / Caliper Lever (Angel: 12°)	Açı / Angel : 12°	1
6	423546	Kaliper Masura Bilya / Caliper Roller Bearing		2
7	421139	Mekanizma Zinciri / Caliper Calibration Shaft Chain (29 Links)		1
8	421127	Ayar Mekanizması Yayli / Caliper Adjusting Mechanism (With Spring)		1
9	421128	Kaliper Mekanizması / Caliper Adjusting Mechanism Shaft		1

Tip / Application

ALL SB6..., SB7..., SERIES

SAF

421116

Kaliper Tamir Takimi Komple (Ø 74 mm) / Caliper Repair Kit Full (Ø 74 mm)

KIT

Orjinal No:

Cross No :



S.No.	Ekersan No.	Ürün Tanıtımı / Description	Ölçü/Dimension	Miktar/Qty.
1	423003	Pabuđu Lastik / Trust Part With Bellow	Ø 74,00 mm	2
2	423004	Toz Lastigi / Shaft Body Dust Rubber	Ø 74,00 mm	2
3	426001	Metal Buç / Tappet Bush	Ø 18x16x10 mm	2
4	421130	Kaliper Dürbün Takimi / Caliper Bridge Assembly - Set		1
5	421125	Masura Bilya Yatagi / Caliper Lever (Angel: 12°)	Açı / Angel : 12°	1
6	423546	Kaliper Masura Bilya / Caliper Roller Bearing		2
7	421139	Mekanizma Zinciri / Caliper Calibration Shaft Chain (29 Links)		7
8	421127	Ayar Mekanizması Yayli / Caliper Adjusting Mechanism (With Spring)		8
9	421128	Kaliper Mekanizması / Caliper Adjusting Mechanism Shaft		9

Tip / Application

ALL SB7... SERIES

SAF

421117

Kaliper Tamir Takimi Komple (Ø 69 mm) / Caliper Repair Kit Full (Ø 69 mm)

KIT

Orjinal No:

Cross No :



S.No.	Ekersan No.	Ürün Tanıtımı / Description	Ölçü/Dimension	Miktar/Qty.
1	423001	Pabuçlu Lastik / Trust Part With Bellow	Ø 69,00 mm	2
2	423002	Toz Lastığı / Shaft Body Dust Rubber	Ø 69,00 mm	2
3	426001	Metal Burç / Tappet Bush	Ø 18x16x10 mm	2
4	421133	Kaliper Dörbün Takımı / Caliper Bridge Assembly - Set		1
5	421122	Masura Bilya Yatagi / Caliper Lever (Angel : 0°)	Açı / Angel : 0°	1
6	423546	Kaliper Masura Bilya / Caliper Roller Bearing		2
7	421139	Mekanizma Zinciri / Caliper Calibration Shaft Chain (29 Links)		1
8	421127	Ayar Mekanizması Yaylı / Caliper Adjusting Mechanism (With Spring)		1
9	421128	Kaliper Mekanizması / Caliper Adjusting Mechanism Shaft		1

Tip / Application

ALL SB6..., SERIES

SAF

421118

Kaliper Tamir Takimi Komple (Ø 69 mm) / Caliper Repair Kit Full (Ø 69 mm)

KIT

Orjinal No:

Cross No :



S.No.	Ekersan No.	Ürün Tanıtımı / Description	Ölçü/Dimension	Miktar/Qty.
1	423001	Pabuçlu Lastik / Trust Part With Bellow	Ø 69,00 mm	2
2	423002	Toz Lastığı / Shaft Body Dust Rubber	Ø 69,00 mm	2
3	426001	Metal Burç / Tappet Bush	Ø 18x16x10 mm	2
4	421133	Kaliper Dörbün Takımı / Caliper Bridge Assembly - Set		1
5	421121	Masura Bilya Yatagi / Caliper Lever (Angel : 0°)	Açı / Angel : 0°	1
6	423546	Kaliper Masura Bilya / Caliper Roller Bearing		2
7	421139	Mekanizma Zinciri / Caliper Calibration Shaft Chain (29 Links)		1
8	421127	Ayar Mekanizması Yaylı / Caliper Adjusting Mechanism (With Spring)		1
9	421128	Kaliper Mekanizması / Caliper Adjusting Mechanism Shaft		1

Tip / Application

ALL SN6..., SN7..., SERIES

SAF

421119

Kaliper Tamir Takimi Komple (Ø 69 mm) / Caliper Repair Kit Full (Ø 69 mm)

KIT

Orjinal No:

Cross No :



S.No.	Ekersan No.	Ürün Tanıtımı / Description	Ölçü/Dimension	Miktar/Qty.
1	423001	Pabuçlu Lastik / Trust Part With Bellow	Ø 69,00 mm	2
2	423002	Toz Lastığı / Shaft Body Dust Rubber	Ø 69,00 mm	2
3	426001	Metal Burç / Tappet Bush	Ø 18x16x10 mm	2
4	421133	Kaliper Dörbün Takımı / Caliper Bridge Assembly - Set		1
5	421123	Masura Bilya Yatagi / Caliper Lever (Angel : 12°)	Açı / Angel : 12°	1
6	423546	Kaliper Masura Bilya / Caliper Roller Bearing		2
7	421139	Mekanizma Zinciri / Caliper Calibration Shaft Chain (29 Links)		1
8	421127	Ayar Mekanizması Yaylı / Caliper Adjusting Mechanism (With Spring)		1
9	421128	Kaliper Mekanizması / Caliper Adjusting Mechanism Shaft		1

Tip / Application

ALL SN7..., SERIES

SAF

421120

Kaliper Tamir Takimi Komple (Ø 69 mm) / Caliper Repair Kit Full (Ø 69 mm)

KIT

Orjinal No:

Cross No :



S.No.	Ekersan No.	Ürün Tanıtımı / Description	Ölçü/Dimension	Miktar/Qty.
1	423001	Pabuđu Lastik / Trust Part With Bellow	Ø 69,00 mm	2
2	423002	Toz Lastığı / Shaft Body Dust Rubber	Ø 69,00 mm	2
3	426001	Metal Burç / Tappet Bush	Ø 18x16x10 mm	2
4	421136	Kaliper Dürbün Takimi / Caliper Bridge Assembly - Set		1
5	421126	Masura Bilya Yatagi / Caliper Lever (Angel: 12°)	Açı / Angel : 12°	1
6	423546	Kaliper Masura Bilya / Caliper Roller Bearing		2
7	421139	Mekanizma Zinciri / Caliper Calibration Shaft Chain (29 Links)		1
8	421189	Kaliper Ayar Dişlisi / Caliper Adjusting Shaft		1
9	421128	Kaliper Mekanizması / Caliper Adjusting Mechanism Shaft		1

Tip / Application

ALL SN7..., SK7..., SERIES

SAF

421222

Kaliper Tamir Takimi Komple (Ø 74 mm) / Caliper Repair Kit Full (Ø 74 mm)

KIT

Orjinal No:

Cross No :



S.No.	Ekersan No.	Ürün Tanıtımı / Description	Ölçü/Dimension	Miktar/Qty.
1	423003	Pabuđu Lastik / Trust Part With Bellow	Ø 74,00 mm	2
2	423004	Toz Lastığı / Shaft Body Dust Rubber	Ø 74,00 mm	2
3	426001	Metal Burç / Tappet Bush	Ø 18x16x10 mm	2
4	423546	Kaliper Masura Bilya / Caliper Roller Bearing		2
5	421131	Kaliper Dürbün Takimi / Caliper Bridge Assembly - Set		1
6	421138	Kaliper Ayar Cıvatası / Caliper Calibration Bolt		2
7	421128	Kaliper Mekanizması / Caliper Adjusting Mechanism Shaft		1
8	421128	Kaliper Mekanizması / Caliper Adjusting Mechanism Shaft		1
9	421139	Mekanizma Zinciri / Caliper Calibration Shaft Chain (29 Links)		1

Tip / Application

ALL SB6..., SB7..., SERIES

SAF

421233

Kaliper Tamir Takimi Komple (Ø 69 mm) / Caliper Repair Kit Full (Ø 69 mm)

KIT

Orjinal No:

Cross No :



S.No.	Ekersan No.	Ürün Tanıtımı / Description	Ölçü/Dimension	Miktar/Qty.
1	423001	Pabuđu Lastik / Trust Part With Bellow	Ø 69,00 mm	2
2	423002	Toz Lastığı / Shaft Body Dust Rubber	Ø 69,00 mm	2
3	426001	Metal Burç / Tappet Bush	Ø 18x16x10 mm	2
4	421133	Kaliper Dürbün Takimi / Caliper Bridge Assembly - Set		1
5	423546	Kaliper Masura Bilya / Caliper Roller Bearing		2
6	421139	Mekanizma Zinciri / Caliper Calibration Shaft Chain (29 Links)		1
7	421127	Ayar Mekanizması Yaylı / Caliper Adjusting Mechanism (With Spring)		1
8	421128	Kaliper Mekanizması / Caliper Adjusting Mechanism Shaft		1

Tip / Application

ALL SN6..., SN7..., SERIES

SAF

421234

Kaliper Tamir Takimi Komple (Ø 69 mm) / Caliper Repair Kit Full (Ø 69 mm)

KIT

Orjinal No:

Cross No :



S.No.	Ekersan No.	Ürün Tanıtımı / Description	Ölçü/Dimension	Miktar/Qty.
1	423001	Pabuçlu Lastik / Trust Part With Bellow	Ø 69,00 mm	2
2	423002	Toz Lastığı / Shaft Body Dust Rubber	Ø 69,00 mm	2
3	426001	Metal Burç / Tappet Bush	Ø 18x16x10 mm	2
4	421135	Kaliper Dürbünü / Caliper Bridge Assembly		1
5	423546	Kaliper Masura Bilya / Caliper Roller Bearing		2
6	421139	Mekanizma Zinciri / Caliper Calibration Shaft Chain (29 Links)		1
7	421127	Ayar Mekanizması Yaylı / Caliper Adjusting Mechanism (With Spring)		1
8	421127	Ayar Mekanizması Yaylı / Caliper Adjusting Mechanism (With Spring)		1

Tip / Application

ALL SK7..., SERIES

SAF

421240

Kaliper Tamir Takimi Komple (Ø 74 mm) / Caliper Repair Kit Full (Ø 74 mm)

KIT

Orjinal No:

Cross No :



S.No.	Ekersan No.	Ürün Tanıtımı / Description	Ölçü/Dimension	Miktar/Qty.
1	421109	Toz Lastığı Tamir Takimi / Caliper Tappet & Boot Kit (Ø 74 mm)	Ø 74,00 mm	1
2	421154	Kaliper Perno Tamir Takimi / Caliper Pin Repair Kit		1
3	421177	Kaliper Kapak Takımı / Caliper Cover Set		1
4	421140	Kaliper Mekanizması / Adjusting Mechanism Shaft		1
5	421138	Kaliper Ayar Dıvatası / Caliper Calibration Bolt		1
6	421145	Kaliper Dürbün Takımı / Caliper Adjustment Carrier		1
7	421147	Kaliper Masura Bilya Takımı / Caliper Roller Bearing Set		1
8	421212	Kaliper Kapak Takımı / Caliper Cover Kit		1
9	421185	Mekanizma Zinciri / Caliper Calibration Shaft Chain (12 Links)	12 Bağlı / Links	1

Tip / Application

SAF

421241

Kaliper Tamir Takimi Komple (Ø 69 mm) / Caliper Repair Kit Full (Ø 69 mm)

KIT

Orjinal No:

Cross No :



S.No.	Ekersan No.	Ürün Tanıtımı / Description	Ölçü/Dimension	Miktar/Qty.
1	421102	Toz Lastığı Tamir Takimi / Caliper Tappet & Boot Kit (Ø 69 mm)	Ø 69,00 mm	1
2	421171	Kaliper Perno Tamir Takimi / Caliper Pin Repair Kit		1
3	421140	Kaliper Mekanizması / Adjusting Mechanism Shaft		1
4	421138	Kaliper Ayar Dıvatası / Caliper Calibration Bolt		1
5	421144	Kaliper Dürbün Takımı / Caliper Adjustment Carrier		1
6	421190	Kaliper Masura Bilya Takımı / Caliper Roller Bearing Set		1
7	421143	Kaliper Ayar Dişlisi / Caliper Adjusting Shaft		1
8	421139	Mekanizma Zinciri / Caliper Calibration Shaft Chain (29 Links)		1
9	421141	Mekanizma Zinciri / Caliper Calibration Shaft Chain (14 Links)	14 Bağlı / Links	1

Tip / Application

421242

Kaliper Tamir Takimi Komple (Ø 69 mm) / Caliper Repair Kit Full (Ø 69 mm)

KIT



Tip / Application

Orjinal No:

Cross No :

S.No.	Ekersan No.	Ürün Tanıtımı / Description	Ölçü/Dimension	Miktar/Qty.
1	421300	Toz Lastiği Tamir Takimi / Caliper Tappet & Boot Kit (Ø 69 mm)	Ø 69,00 mm	1
2	421249	Kaliper Perno Tamir Takimi / Caliper Pin Repair Kit		1
3	421128	Kaliper Mekanizması / Caliper Adjusting Mechanism Shaft		1
4	421127	Ayar Mekanizması Yaylı / Caliper Adjusting Mechanism (With Spring)		1
5	421138	Kaliper Ayar Civatası / Caliper Calibration Bolt		2
6	421137	Kaliper Dürbün Takimi / Caliper Bridge Assembly - Set		1
7	421347	Kaliper Masura Bilya Takimi / Caliper Roller Bearing Set		1
8	421150	Kaliper Kapak Takimi Sac / Caliper Cover Kit Metal		1
9	421139	Mekanizma Zinciri / Caliper Calibration Shaft Chain (29 Links)		1

SAF

421243

Kaliper Tamir Takimi Komple (Ø 69 mm) / Caliper Repair Kit Full (Ø 69 mm)

KIT



Tip / Application

Orjinal No:

Cross No :

S.No.	Ekersan No.	Ürün Tanıtımı / Description	Ölçü/Dimension	Miktar/Qty.
1	421300	Toz Lastiği Tamir Takimi / Caliper Tappet & Boot Kit (Ø 69 mm)	Ø 69,00 mm	1
2	421167	Kaliper Perno Tamir Takimi / Caliper Pin Repair Kit		1
3	421128	Kaliper Mekanizması / Caliper Adjusting Mechanism Shaft		1
4	421127	Ayar Mekanizması Yaylı / Caliper Adjusting Mechanism (With Spring)		1
5	421138	Kaliper Ayar Civatası / Caliper Calibration Bolt		2
6	421134	Kaliper Dürbün Takimi / Caliper Bridge Assembly - Set		1
7	421146	Kaliper Masura Bilya Takimi / Caliper Roller Bearing Set		1
8	421139	Mekanizma Zinciri / Caliper Calibration Shaft Chain (29 Links)		1
9	421139	Mekanizma Zinciri / Caliper Calibration Shaft Chain (29 Links)		1

SAF

421244

Kaliper Tamir Takimi Komple (Ø 74 mm) / Caliper Repair Kit Full (Ø 74 mm)

KIT



Tip / Application

Orjinal No:

Cross No :

S.No.	Ekersan No.	Ürün Tanıtımı / Description	Ölçü/Dimension	Miktar/Qty.
1	421306	Toz Lastiği Tamir Takimi / Caliper Tappet & Boot Kit (Ø 74 mm)	Ø 74,00 mm	1
2	421161	Kaliper Perno Tamir Takimi / Caliper Pin Repair Kit		1
3	421128	Kaliper Mekanizması / Caliper Adjusting Mechanism Shaft		1
4	421127	Ayar Mekanizması Yaylı / Caliper Adjusting Mechanism (With Spring)		1
5	421138	Kaliper Ayar Civatası / Caliper Calibration Bolt		2
6	421131	Kaliper Dürbün Takimi / Caliper Bridge Assembly - Set		1
7	421146	Kaliper Masura Bilya Takimi / Caliper Roller Bearing Set		1
8	421139	Mekanizma Zinciri / Caliper Calibration Shaft Chain (29 Links)		1

421245

Kaliper Tamir Takimi Komple (Ø 74 mm) / Caliper Repair Kit Full (Ø 74 mm)

KIT

Orjinal No:

Cross No :



S.No.	Ekersan No.	Ürün Tanıtımı / Description	Ölçü/Dimension	Miktar/Qty.
1	421106	Toz Lastığı Tamir Takimi / Caliper Tappet & Boot Kit (Ø 74 mm)	Ø 74,00 mm	1
2	421161	Kaliper Perno Tamir Takimi / Caliper Pin Repair Kit		1
3	421128	Kaliper Mekanizması / Caliper Adjusting Mechanism Shaft		1
4	421127	Ayar Mekanizması Yaylı / Caliper Adjusting Mechanism (With Spring)		1
5	421138	Kaliper Ayar Civatası / Caliper Calibration Bolt		2
6	421134	Kaliper Dürbün Takimi / Caliper Bridge Assembly - Set		1
7	421146	Kaliper Masura Bilya Takimi / Caliper Roller Bearing Set		1
8	421150	Kaliper Kapak Takimi Sac / Caliper Cover Kit Metal		1

Tip / Application

421246

Kaliper Tamir Takimi Komple (Ø 74 mm) / Caliper Repair Kit Full (Ø 74 mm)

KIT

Orjinal No:

Cross No :



S.No.	Ekersan No.	Ürün Tanıtımı / Description	Ölçü/Dimension	Miktar/Qty.
1	421106	Toz Lastığı Tamir Takimi / Caliper Tappet & Boot Kit (Ø 74 mm)	Ø 74,00 mm	1
2	421161	Kaliper Perno Tamir Takimi / Caliper Pin Repair Kit		1
3	421128	Kaliper Mekanizması / Caliper Adjusting Mechanism Shaft		1
4	421127	Ayar Mekanizması Yaylı / Caliper Adjusting Mechanism (With Spring)		1
5	421138	Kaliper Ayar Civatası / Caliper Calibration Bolt		2
6	421131	Kaliper Dürbün Takimi / Caliper Bridge Assembly - Set		1
7	421147	Kaliper Masura Bilya Takimi / Caliper Roller Bearing Set		1
8	421139	Mekanizma Zinciri / Caliper Calibration Shaft Chain (29 Links)		1

Tip / Application

421247

Kaliper Tamir Takimi Komple (Ø 69 mm) / Caliper Repair Kit Full (Ø 69 mm)

KIT

Orjinal No:

Cross No :



S.No.	Ekersan No.	Ürün Tanıtımı / Description	Ölçü/Dimension	Miktar/Qty.
1	421100	Toz Lastığı Tamir Takimi / Caliper Tappet & Boot Kit (Ø 69 mm)	Ø 69,00 mm	1
2	421172	Kaliper Perno Tamir Takimi / Caliper Pin Repair Kit		1
3	421128	Kaliper Mekanizması / Caliper Adjusting Mechanism Shaft		1
4	421127	Ayar Mekanizması Yaylı / Caliper Adjusting Mechanism (With Spring)		1
5	421138	Kaliper Ayar Civatası / Caliper Calibration Bolt		2
6	421137	Kaliper Dürbün Takimi / Caliper Bridge Assembly - Set		1
7	421167	Kaliper Masura Bilya Takimi / Caliper Roller Bearing Set		1
8	421142	Kaliper Ayar Dişlisi / Caliper Mechanism Gear		1
9	421139	Mekanizma Zinciri / Caliper Calibration Shaft Chain (29 Links)		1

Tip / Application

SAF

421248

Kaliper Tamir Takimi Komple (Ø 69 mm) / Caliper Repair Kit Full (Ø 69 mm)

KIT

Orjinal No:

Cross No :



S.No.	Ekersan No.	Ürün Tanıtımı / Description	Ölçü/Dimension	Miktar/Qty.
1	421235	Toz Lastığı Tamir Takimi / Caliper Tappet & Boot Kit	Ø 69,00 mm	1
2	421250	Kaliper Perno Tamir Takimi / Caliper Pin Repair Kit		1
3	421128	Kaliper Mekanizması / Caliper Adjusting Mechanism Shaft		1
4	421237	Ayar Mekanizması Yaysız / Caliper Adjusting Mechanism (Without Spring)		1
5	421236	Kaliper Ayar Civatası / Caliper Calibration Bolt	9,50 mm	2
6	421137	Kaliper Dürbün Takimi / Caliper Bridge Assembly - Set		1
7	421238	Kaliper Masura Bilya Takimi / Caliper Roller Bearing Set		1
8	422031	Cıvır Ayar Civatası / Caliper Adjuster Bolt	M10x1,5x50 mm	1
9	421227	Kaliper Kapak Takimi Sac / Caliper Cover Kit Metal		1
10	421139	Mekanizma Zinciri / Caliper Calibration Shaft Chain (29 Links)		1

Tip / Application

ALL SL7..., SM7..., SERIES

SAF

421258

Kaliper Tamir Takimi Komple (Ø 74 mm) / Caliper Repair Kit Full (Ø 74 mm)

KIT

Orjinal No:

Cross No :



S.No.	Ekersan No.	Ürün Tanıtımı / Description	Ölçü/Dimension	Miktar/Qty.
1	421306	Toz Lastığı Tamir Takimi / Caliper Tappet & Boot Kit (Ø 74 mm)	Ø 74,00 mm	1
2	421154	Kaliper Perno Tamir Takimi / Caliper Pin Repair Kit		1
3	421128	Kaliper Mekanizması / Caliper Adjusting Mechanism Shaft		1
4	421127	Ayar Mekanizması Yaylı / Caliper Adjusting Mechanism (With Spring)		1
5	421138	Kaliper Ayar Civatası / Caliper Calibration Bolt		2
6	421134	Kaliper Dürbün Takimi / Caliper Bridge Assembly - Set		1
7	421146	Kaliper Masura Bilya Takimi / Caliper Roller Bearing Set		1
8	421150	Kaliper Kapak Takimi Sac / Caliper Cover Kit Metal		1

Tip / Application

SAF

421261

Kaliper Tamir Takimi Komple (Ø 69 mm) / Caliper Repair Kit Full (Ø 69 mm)

KIT

Orjinal No:

Cross No :



S.No.	Ekersan No.	Ürün Tanıtımı / Description	Ölçü/Dimension	Miktar/Qty.
1	423001	Pabuđu Lastik / Trust Part With Bellow	Ø 69,00 mm	2
2	423002	Toz Lastığı / Shaft Body Dust Rubber	Ø 69,00 mm	2
3	426001	Metal Buç / Tappet Bush	Ø 18x16x10 mm	2
4	421133	Kaliper Dürbün Takimi / Caliper Bridge Assembly - Set		1
5	421224	Masura Bilya Yatığı / Caliper Lever (Angle : 12°)	Aç / Angel : 12°	1
6	423546	Kaliper Masura Bilya / Caliper Roller Bearing		2
7	421139	Mekanizma Zinciri / Caliper Calibration Shaft Chain (29 Links)		1
8	421127	Ayar Mekanizması Yaylı / Caliper Adjusting Mechanism (With Spring)		1
9	421128	Kaliper Mekanizması / Caliper Adjusting Mechanism Shaft		1

Tip / Application

ALL SN7..., SERIES

SAF

422168

Kaliper Tamir Takımı Komple (Sag) / Caliper Repair Kit Full (Right)

KIT

Orjinal No:

Cross No :

S.No.	Ekersan No.	Ürün Tanıtımı / Description	Ölçü/Dimension	Miktar/Qty.
1	422103	Perno Tamir Takımı / Caliper Boot & Pin Repair Kit		1
2	422152	Kaliper Ayar Mekanizma Seti / Caliper Adjusting Mechanism Set	109 mm - 87 mm	1
3	422123	Balata Tutucusu Sag / Caliper Lining Plate With Groove (Right)		1
4	422124	Kaliper Masura Bilya Takımı / Caliper Roller Bearing Kit		1
5	422119	Kaliper Kapak Conta Takımı / Cover Plate Gasket Kit		1
6	425008	Vida - Screw	M10x1x40 mm	8



Tip / Application

SAF

422169

Kaliper Tamir Takımı Komple (Sol) / Caliper Repair Kit Full (Left)

KIT

Orjinal No:

Cross No :

S.No.	Ekersan No.	Ürün Tanıtımı / Description	Ölçü/Dimension	Miktar/Qty.
1	422103	Perno Tamir Takımı / Caliper Boot & Pin Repair Kit		1
2	422152	Kaliper Ayar Mekanizma Seti / Caliper Adjusting Mechanism Set	109 mm - 87 mm	1
3	422122	Balata Tutucusu Sol / Caliper Lining Plate With Groove (Left)		1
4	422124	Kaliper Masura Bilya Takımı / Caliper Roller Bearing Kit		1
5	422119	Kaliper Kapak Conta Takımı / Cover Plate Gasket Kit		1
6	425008	Vida - Screw	M10x1x40 mm	8



Tip / Application

SAF

422170

Kaliper Tamir Takımı Komple (Sag) / Caliper Repair Kit Full (Right)

KIT

Orjinal No:

Cross No :

S.No.	Ekersan No.	Ürün Tanıtımı / Description	Ölçü/Dimension	Miktar/Qty.
1	422103	Perno Tamir Takımı / Caliper Boot & Pin Repair Kit		1
2	422153	Kaliper Ayar Mekanizma Seti / Caliper Adjusting Mechanism Set	109 mm - 87 mm	1
3	422121	Balata Tutucusu Sag / Caliper Lining Plate With Pin (Right)		1
4	422124	Kaliper Masura Bilya Takımı / Caliper Roller Bearing Kit		4
5	422119	Kaliper Kapak Conta Takımı / Cover Plate Gasket Kit		5
6	425008	Vida - Screw	M10x1x40 mm	8



Tip / Application

422171

Kaliper Tamir Takimi Komple (Sol) / Caliper Repair Kit Full (Left)

KIT

Orjinal No:

Cross No :



S.No.	Ekersan No.	Ürün Tanıtımı / Description	Ölçü/Dimension	Miktar/Qty.
1	422103	Perno Tamir Takimi / Caliper Boot & Pin Repair Kit		1
2	422153	Kaliper Ayar Mekanizma Seti / Caliper Adjusting Mechanism Set	109 mm - 87 mm	1
3	422120	Baketa Tutucusu Sol / Caliper Lining Plate With Pin (Left)		1
4	422124	Kaliper Masura Bilya Takimi / Caliper Roller Bearing Kit		4
5	422119	Kaliper Kapak Conta Takimi / Cover Plate Gasket Kit		5
6	425008	Vida - Screw	M10x1x40 mm	8

Tip / Application

422172

Kaliper Tamir Takimi Komple (Sag) / Caliper Repair Kit Full (Right)

KIT

Orjinal No:

Cross No :



S.No.	Ekersan No.	Ürün Tanıtımı / Description	Ölçü/Dimension	Miktar/Qty.
1	422129	Perno Tamir Takimi / Caliper Boot & Pin Repair Kit		1
2	422158	Kaliper Ayar Mekanizma Seti (Pimli - Uzun) / Caliper Adjusting Mechanism Set With Pin (Long)	114 mm - 91 mm	1
3	422125	Baketa Tutucusu Sag / Caliper Lining Plate With Groove (Right)		1
4	422124	Kaliper Masura Bilya Takimi / Caliper Roller Bearing Kit		4
5	422119	Kaliper Kapak Conta Takimi / Cover Plate Gasket Kit		5
6	425008	Vida - Screw	M10x1x40 mm	8

Tip / Application

422173

Kaliper Tamir Takimi Komple (Sol) / Caliper Repair Kit Full (Left)

KIT

Orjinal No:

Cross No :



S.No.	Ekersan No.	Ürün Tanıtımı / Description	Ölçü/Dimension	Miktar/Qty.
1	422129	Perno Tamir Takimi / Caliper Boot & Pin Repair Kit		1
2	422158	Kaliper Ayar Mekanizma Seti (Pimli - Uzun) / Caliper Adjusting Mech.	114 mm - 91 mm	1
3	422126	Baketa Tutucusu Sol / Caliper Lining Plate With Groove (Left)		1
4	422124	Kaliper Masura Bilya Takimi / Caliper Roller Bearing Kit		4
5	422119	Kaliper Kapak Conta Takimi / Cover Plate Gasket Kit		5
6	425008	Vida - Screw	M10x1x40 mm	8

Tip / Application

422174

Kaliper Tamir Takimi Komple (Sag) / Caliper Repair Kit Full (Right)

KIT

Original No:

Cross No :



S.No.	Ekersan No.	Ürün Tanıtımı / Description	Ölçü/Dimension	Miktar/Qty.
1	422103	Perno Tamir Takimi / Caliper Boot & Pin Repair Kit		1
2	422152	Kaliper Ayar Mekanizma Seti / Caliper Adjusting Mechanism Set	109 mm - 87 mm	1
3	422123	Balata Tutucusu Sag / Caliper Lining Plate With Groove (Right)		1
4	422124	Kaliper Masura Bilya Takimi / Caliper Roller Bearing Kit		1
5	422119	Kaliper Kapak Conta Takimi / Cover Plate Gasket Kit		1
6	422115	Masura Bilya Yatagi / Caliper Lever		1
7	425008	Vida Screw	M10x1x40 mm	8

Tip / Application

422175

Kaliper Tamir Takimi Komple (Sol) / Caliper Repair Kit Full (Left)

KIT

Original No:

Cross No :



S.No.	Ekersan No.	Ürün Tanıtımı / Description	Ölçü/Dimension	Miktar/Qty.
1	422103	Perno Tamir Takimi / Caliper Boot & Pin Repair Kit		1
2	422152	Kaliper Ayar Mekanizma Seti / Caliper Adjusting Mechanism Set	109 mm - 87 mm	1
3	422122	Balata Tutucusu Sol / Caliper Lining Plate With Groove (Left)		1
4	422124	Kaliper Masura Bilya Takimi / Caliper Roller Bearing Kit		1
5	422119	Kaliper Kapak Conta Takimi / Cover Plate Gasket Kit		1
6	422115	Masura Bilya Yatagi / Caliper Lever		1
7	425008	Vida Screw	M10x1x40 mm	8

Tip / Application

422176

Kaliper Tamir Takimi Komple (Sag) / Caliper Repair Kit Full (Right)

KIT

Original No:

Cross No :



S.No.	Ekersan No.	Ürün Tanıtımı / Description	Ölçü/Dimension	Miktar/Qty.
1	422103	Perno Tamir Takimi / Caliper Boot & Pin Repair Kit		1
2	422153	Kaliper Ayar Mekanizma Seti / Caliper Adjusting Mechanism Set	109 mm - 87 mm	1
3	422121	Balata Tutucusu Sag / Caliper Lining Plate With Pin (Right)		1
4	422124	Kaliper Masura Bilya Takimi / Caliper Roller Bearing Kit		4
5	422119	Kaliper Kapak Conta Takimi / Cover Plate Gasket Kit		5
6	422115	Masura Bilya Yatagi / Caliper Lever		6
7	425008	Vida Screw	M10x1x40 mm	8

Tip / Application

SAF

422177

Kaliper Tamir Takimi Komple (Sol) / Caliper Repair Kit Full (Left)

KIT

Orjinal No:

Cross No :



S.No.	Ekersan No.	Ürün Tanıtımı / Description	Ölçü/Dimension	Miktar/Qty.
1	422103	Perno Tamir Takimi / Caliper Boot & Pin Repair Kit		1
2	422153	Kaliper Ayar Mekanizma Seti / Caliper Adjusting Mechanism Set	109 mm - 87 mm	1
3	422120	Bakita Tutucusu Sol / Caliper Lining Plate With Pin (Left)		1
4	422124	Kaliper Masura Bilya Takimi / Caliper Roller Bearing Kit		1
5	422119	Kaliper Kapak Conta Takimi / Cover Plate Gasket Kit		1
6	422115	Masura Bilya Yatağı / Caliper Lever		1
7	425008	Vida - Screw	M10x1x40 mm	8

Tip / Application

SAF

422178

Kaliper Tamir Takimi Komple (Sağ) / Caliper Repair Kit Full (Right)

KIT

Orjinal No:

Cross No :



S.No.	Ekersan No.	Ürün Tanıtımı / Description	Ölçü/Dimension	Miktar/Qty.
1	422129	Perno Tamir Takimi / Caliper Boot & Pin Repair Kit		1
2	422158	Kaliper Ayar Mekanizma Seti (Pimli - Uzun) / Caliper Adjusting Mech.	114 mm - 91 mm	1
3	422125	Bakita Tutucusu Sağ / Caliper Lining Plate With Groove (Right)		1
4	422124	Kaliper Masura Bilya Takimi / Caliper Roller Bearing Kit		1
5	422119	Kaliper Kapak Conta Takimi / Cover Plate Gasket Kit		1
6	422115	Masura Bilya Yatağı / Caliper Lever		1
7	425008	Vida - Screw	M10x1x40 mm	8

Tip / Application

SAF

422179

Kaliper Tamir Takimi Komple (Sol) / Caliper Repair Kit Full (Left)

KIT

Orjinal No:

Cross No :



S.No.	Ekersan No.	Ürün Tanıtımı / Description	Ölçü/Dimension	Miktar/Qty.
1	422129	Perno Tamir Takimi / Caliper Boot & Pin Repair Kit		1
2	422158	Kaliper Ayar Mekanizma Seti (Pimli - Uzun) / Caliper Adjusting Mech.	114 mm - 91 mm	1
3	422126	Bakita Tutucusu Sol / Caliper Lining Plate With Groove (Left)		1
4	422124	Kaliper Masura Bilya Takimi / Caliper Roller Bearing Kit		1
5	422119	Kaliper Kapak Conta Takimi / Cover Plate Gasket Kit		1
6	422115	Masura Bilya Yatağı / Caliper Lever		1
7	425008	Vida - Screw	M10x1x40 mm	8

Tip / Application

SAF

423161

Kaliper Tamir Takimi Komple / Caliper Repair Kit Full

KIT

Orjinal No:

Cross No :



S.No.	Ekersan No.	Ürün Tanıtımı / Description	Ölçü/Dimension	Miktar/Qty.
1	423160	Komple Mekanizma Seti / Caliper Mechanism Complete Set		1
2	423131	Kaliper Perno & Lastik Tamir Takimi / Caliper Pin & Boot Repair Kit		1
3	423158	Kaliper Balata Tutucu Takimi / Caliper Pad Retainer Set		1

Tip / Application

PISTON SERIES

SAF

423162

Kaliper Tamir Takimi Komple / Caliper Repair Kit Full

KIT

Orjinal No:

Cross No :



S.No.	Ekersan No.	Ürün Tanıtımı / Description	Ölçü/Dimension	Miktar/Qty.
1	423144	Komple Mekanizma Seti / Caliper Mechanism Complete Set		1
2	423100	Kaliper Perno & Lastik Tamir Takimi / Caliper Pin & Boot Repair Kit		1
3	423158	Kaliper Balata Tutucu Takimi / Caliper Pad Retainer Set		1

Tip / Application

PLATE SERIES

SAF

423163

Kaliper Tamir Takimi Komple / Caliper Repair Kit Full

KIT

Orjinal No:

Cross No :



S.No.	Ekersan No.	Ürün Tanıtımı / Description	Ölçü/Dimension	Miktar/Qty.
1	423144	Komple Mekanizma Seti / Caliper Mechanism Complete Set		1
2	423106	Kaliper Perno & Lastik Tamir Takimi / Caliper Pin & Boot Repair Kit		1
3	423158	Kaliper Balata Tutucu Takimi / Caliper Pad Retainer Set		1

Tip / Application

PLATE SERIES

SAF

426142

Kaliper Tamir Takimi Komple (Pimsiz) / Caliper Repair Kit Full (Without Pin)

KIT



Orjinal No:

Cross No :

S.No.	Ekersan No.	Ürün Tanıtımı / Description	Ölçü/Dimension	Miktar/Qty.
1	426146	Tamir Takimi Komple / Caliper Repair Kit Full (Without Pin)		1
2	426129	Kaliper Masura Bilya Yatagi Takimi / Caliper Lever Repair Kit		1
3	426130	Kaliper Masura Bilya Seti / Caliper Roller Bearing Set		1
4	426123	Kaliper Perno Tamir Takimi / Caliper Pin Repair Kit		1
5	426138	Kaliper Ayar Mekanizması / Caliper Adjusting Mechanism		1
6	429026	Kaliper Tapasi / Caliper Plug		2

Tip / Application

TSB 3709 / 4309 / 4312 SERIES

SAF

426143

Kaliper Tamir Takimi Komple (Pimli) / Caliper Repair Kit Full (With Pin)

KIT



Orjinal No:

Cross No :

S.No.	Ekersan No.	Ürün Tanıtımı / Description	Ölçü/Dimension	Miktar/Qty.
1	426147	Tamir Takimi Komple / Caliper Repair Kit Full (With Pin)		1
2	426129	Kaliper Masura Bilya Yatagi Takimi / Caliper Lever Repair Kit		1
3	426130	Kaliper Masura Bilya Seti / Caliper Roller Bearing Set		1
4	426123	Kaliper Perno Tamir Takimi / Caliper Pin Repair Kit		1
5	426138	Kaliper Ayar Mekanizması / Caliper Adjusting Mechanism		1
6	429026	Kaliper Tapasi / Caliper Plug		2
7	426059	Plastik Burç / Plastic Bushing	Ø 35,7x35,4x87 mm	8

Tip / Application

TSB 3709 / 4309 / 4312 SERIES

SAF

426144

Kaliper Tamir Takimi Komple (Pimsiz) / Caliper Repair Kit Full (Without Pin)

KIT



Orjinal No:

Cross No :

S.No.	Ekersan No.	Ürün Tanıtımı / Description	Ölçü/Dimension	Miktar/Qty.
1	426146	Tamir Takimi Komple / Caliper Repair Kit Full (Without Pin)		1
2	426129	Kaliper Masura Bilya Yatagi Takimi / Caliper Lever Repair Kit		1
3	426130	Kaliper Masura Bilya Seti / Caliper Roller Bearing Set		1

Tip / Application

TSB 3709 / 4309 / 4312 SERIES

SAF

426145

Kaliper Tamir Takimi Komple (Pimli) / Caliper Repair Kit Full (With Pin)

KIT

Orjinal No:

Cross No :



S.No.	Ekersan No.	Ürün Tanıtımı / Description	Ölçü/Dimension	Miktar/Qty.
1	426147	Tamir Takimi Komple / Caliper Repair Kit Full (With Pin)		1
2	426129	Kaliper Masura Bilya Yatagi Takimi / Caliper Lever Repair Kit		1
3	426130	Kaliper Masura Bilya Seti / Caliper Roller Bearing Set		1

Tip / Application

TSB 3709 / 4309 / 4312 SERIES

SAF

426146

Tamir Takimi Komple / Caliper Repair Kit Full (Without Pin)

KIT

Orjinal No:

Cross No :



S.No.	Ekersan No.	Ürün Tanıtımı / Description	Ölçü/Dimension	Miktar/Qty.
1	426122	Pim Tamir Takimi / Caliper Pin Repair Kit (Without Pin)		1
2	426128	Köprü Bağlantısı / Caliper Bridge Assembly		1
3	426124	Kaliper Mekanizmalı Kapak / Caliper Cover Mechanism		1
4	426126	Kaliper Ayar Dıvatası / Caliper Calibration Bolt		1
5	426125	Kaliper Mekanizma Bilya Yatagi / Caliper Mechanism Bearing House		1
6	426141	Mekanizma Yatagi / Caliper Mechanism Housing		1
7	426140	Kaliper Mekanizmalı Bilya Yatagi / Caliper Mechanism Bearing House		1
8	426131	Kaliper Düz Rulman Seti / Caliper Flat Bearing Set		1
9	428064	Kilitleme Pulu / Locking Washer		1

Tip / Application

TSB 3709 / 4309 / 4312 SERIES

SAF

426147

Tamir Takimi Komple / Caliper Repair Kit Full (With Pin)

KIT

Orjinal No:

Cross No :



S.No.	Ekersan No.	Ürün Tanıtımı / Description	Ölçü/Dimension	Miktar/Qty.
1	426127	Pim Tamir Takimi / Caliper Pin Repair Kit (With Pin)		1
2	426128	Köprü Bağlantısı / Caliper Bridge Assembly		1
3	426124	Kaliper Mekanizmalı Kapak / Caliper Cover Mechanism		1
4	426126	Kaliper Ayar Dıvatası / Caliper Calibration Bolt		1
5	426125	Kaliper Mekanizma Bilya Yatagi / Caliper Mechanism Bearing House		1
6	426141	Mekanizma Yatagi / Caliper Mechanism Housing		1
7	426140	Kaliper Mekanizmalı Bilya Yatagi / Caliper Mechanism Bearing House		1
8	428064	Kilitleme Pulu / Locking Washer		1

Tip / Application

TSB 3709 / 4309 / 4312 SERIES

SAF

427138

Tamir Takimi Komple / Caliper Repair Kit Full

KIT

Orjinal No:

Cross No :



Tip / Application

SBS 2220 SERIES

S.No.	Ekersan No.	Ürün Tanıtımı / Description	Ölçü/Dimension	Miktar/Qty.
1	427137	Mekanizma Playti / Mechanism Plate		1
2	427136	Kaliper Ayar Civatası / Caliper Calibration Bolt		1
3	427135	Kaliper Mekanizması / Caliper Mechanism		1
4	427134	Mekanizma Bilya Yatağı / Bearing House		1
5	427133	Masura Bilya Yatağı / Caliper Lever		1
6	427129	Masura Bilya Takımı / Roller Bearing Kit		1
7	427130	Masura Bilya Takımı / Roller Bearing Kit		1
8	427131	Kaliper Bilya Takımı / Caliper Bearing Kit		1
9	423078	Kaliper Toz Lastiği / Caliper Dust Cover		1
10	428091	Sabitleme Plastığı / Locking Plastic		1
11	428092	Mekanizma Bilya Yatağı / Bearing House		2

SAF

427139

Kaliper Tamir Takimi Komple / Caliper Repair Kit Full

KIT

Orjinal No:

Cross No :



Tip / Application

SBS 2220 SERIES

S.No.	Ekersan No.	Ürün Tanıtımı / Description	Ölçü/Dimension	Miktar/Qty.
1	427138	Tamir Takımı Komple / Caliper Repair Kit Full		1
2	427120	Perno Tamir Takımı / Pin Repair Kit		1
3	423079	Ayar Dişlisi / Plastic Adjuster Gear		1
4	423077	Kaliper Ayar Dişlisi / Caliper Adjusting Gear		1
5	428086	Kaliper Keçesi / Caliper Seal		1
6	423076	Kaliper Tapası / Caliper Plug		1
7	423080	Kaliper Tapası / Caliper Plug		1

427120

Kaliper Perno Tamir Takimi / Caliper Pin Repair Kit

SAF Haldex Module T series

Orjinal No: 3434386100

Cross No :

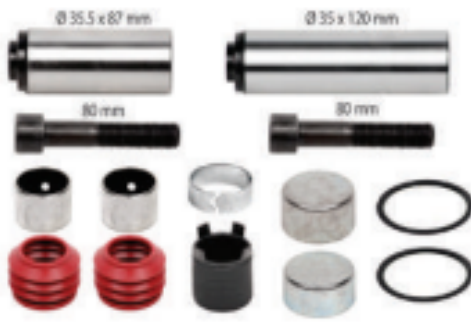

S.No.	Ekersan No.	Ürün Tanıtımı / Description	Ölçü/Dimension	Miktar/Qty.
1	424051	Kaliper Pernosu / Caliper Bolt	Ø 35x120 mm	1
2	424052	Kaliper Pernosu / Caliper Bolt	Ø 35,5x87 mm	1
3	425004	Kaliper Vidası / Caliper Screw	M16x1,5x80 mm	2
4	429038	Perno Tapası / Bolt Plug	42x26 mm	1
5	429039	Perno Tapası / Bolt Plug	Ø 45x22 mm	1
6	423075	Toz Lastiği / Dust Cover		2
7	426009	Metal Burç / Bushing	Ø 35x39x30 mm	2
8	426069	Plastik Burç / Plastic Bushing	Ø 35,7x35,4x87 mm	1
9	426051	Metal Burç / Bushing	Ø 39,5x36x14,5 mm	1
10	426083	Pul / Washer		2

Tip / Application

SBS 2220 SERIES

427121

Kaliper Ayar Disiisi Plastik Takimi / Caliper Adjuster Gear Plastic

SAF Haldex Module T series

Orjinal No:

Cross No :



S.No.	Ekersan No.	Ürün Tanıtımı / Description	Ölçü/Dimension	Miktar/Qty.
1	423077	Kaliper Ayar Disiisi / Caliper Adjusting Gear		5
2	428086	Kaliper Keçesi / Caliper Seal		5

Tip / Application

SBS 2220 SERIES

427122

Kaliper Plastik Tapa Seti / Caliper Plastic Cap Set

SAF Haldex Module T series

Orjinal No:

Cross No :



S.No.	Ekersan No.	Ürün Tanıtımı / Description	Ölçü/Dimension	Miktar/Qty.
1	423076	Kaliper Tapası / Caliper Plug		5

SAF

427123

SAF Haldex Module T series



Tip / Application

SBS 2220 SERIES

Kaliper Toz Lastik Takımı / Caliper Dust Cover Kit

Orjinal No:

Cross No :

S.No.	Ekersan No.	Ürün Tanıtımı / Description	Ölçü/Dimension	Miktar/Qty.
1	423078	Kaliper Toz Lastiği / Caliper Dust Cover		5

SAF

427124

SAF Haldex Module T series



Tip / Application

SBS 2220 SERIES

Kaliper Ayar Plastik Dişli Takımı / Caliper Plastic Adjuster Gear Kit

Orjinal No:

Cross No :

S.No.	Ekersan No.	Ürün Tanıtımı / Description	Ölçü/Dimension	Miktar/Qty.
1	423079	Ayar Dişlisi / Plastic Adjuster Gear		5

SAF

427125

SAF Haldex Module T series



Tip / Application

SBS 2220 SERIES

Kaliper Plastik Tapa Seti / Caliper Plastic Cap Set

Orjinal No:

Cross No :

S.No.	Ekersan No.	Ürün Tanıtımı / Description	Ölçü/Dimension	Miktar/Qty.
1	423080	Plastik Tapa / Plastic Cap		5

SAF

427126

Kaliper Mekanizma Sabitleme Takimi / Caliper Mechanism Locking Kit

SAF Haldex Module T series

Orjinal No:

Cross No :

S.No.	Ekersan No.	Ürün Tanıtımı / Description	Ölçü/Dimension	Miktar/Qty.
1	427131	Kaliper Bilya Takımı / Caliper Bearing Kit		8



Tip / Application

SBS 2220 SERIES

SAF

427127

Kaliper Mekanizma Bilya Yatak Takımı / Caliper Mechanism Bearing House Kit

SAF Haldex Module T series

Orjinal No:

Cross No :

S.No.	Ekersan No.	Ürün Tanıtımı / Description	Ölçü/Dimension	Miktar/Qty.
1	428092	Mekanizma Bilya Yatağı / Bearing House		5



Tip / Application

SBS 2220 SERIES

SAF

427128

Kaliper Masura Bilya / Caliper Roller Bearing

SAF Haldex Module T series

Orjinal No:

Cross No :

S.No.	Ekersan No.	Ürün Tanıtımı / Description	Ölçü/Dimension	Miktar/Qty.
1	427128	Kaliper Masura Bilya / Caliper Roller Bearing		1
2	426054	Bilya Ball Bearing		1



Tip / Application

SBS 2220 SERIES

SAF

427129

Kaliper Masura Bilya Takimi / Caliper Roller Bearing Kit

SAF Haldex Module T series

Orjinal No:

Cross No :

S.No.	Ekersan No.	Ürün Tanıtım / Description	Ölçü/Dimension	Miktar/Qty.
1	423870	Kaliper Masura Bilya / Caliper Roller Bearing		2



Tip / Application

SBS 2220 SERIES

SAF

427130

Kaliper Masura Bilya Takimi / Caliper Roller Bearing Kit

SAF Haldex Module T series

Orjinal No:

Cross No :

S.No.	Ekersan No.	Ürün Tanıtım / Description	Ölçü/Dimension	Miktar/Qty.
1	427128	Kaliper Masura Bilya / Caliper Roller Bearing		1
2	426054	Bilya /		1



Tip / Application

SBS 2220 SERIES

SAF

427131

Kaliper Bilya Takimi / Caliper Bearing Kit

SAF Haldex Module T series

Orjinal No:

Cross No :

S.No.	Ekersan No.	Ürün Tanıtım / Description	Ölçü/Dimension	Miktar/Qty.
1	423871	Bilya / Ball Bearing		1
2	423872	Bilya /		1
3	423073	Bilya / Ball Bearing		1
4	423874	Bilya / Ball Bearing		1



Tip / Application

SBS 2220 SERIES

SAF

427132

Kaliper Balata Tutucu / Caliper Pad Retainer

SAF Haldex Module T series

Orjinal No:

Cross No :



S.No.	Ekersan No.	Ürün Tanıtımı / Description	Ölçü/Dimension	Miktar/Qty.
1	427132	Kaliper Balata Tutucu / Caliper Pad Retainer		1

Tip / Application

SBS 2220 SERIES

SAF

427133

Masura Bilya Yatagi / Caliper Lever

SAF Haldex Module T series

Orjinal No:

Cross No :



S.No.	Ekersan No.	Ürün Tanıtımı / Description	Ölçü/Dimension	Miktar/Qty.
1	427133	Masura Bilya Yatagi / Caliper Lever		1

Tip / Application

SBS 2220 SERIES

SAF

427134

Mekanizma Bilya Yatagi / Caliper Mechanism Bearing House

SAF Haldex Module T series

Orjinal No:

Cross No :



S.No.	Ekersan No.	Ürün Tanıtımı / Description	Ölçü/Dimension	Miktar/Qty.
1	427134	Mekanizma Bilya Yatagi / Caliper Mechanism Bearing House		1

Tip / Application

SBS 2220 SERIES

SAF

427135

Kaliper Mekanizması / Caliper Adjusting Mechanism

SAF Haldex Module T series

Orjinal No:

Cross No :



S.No.	Ekersan No.	Ürün Tanıtımı / Description	Ölçü/Dimension	Miktar/Qty.
1	427135	Kaliper Mekanizması / Caliper Adjusting Mechanism		1

Tip / Application

SBS 2220 SERIES

SAF

427136

Kaliper Ayar Civatası / Caliper Calibration Bolt

SAF Haldex Module T series

Orjinal No:

Cross No :



S.No.	Ekersan No.	Ürün Tanıtımı / Description	Ölçü/Dimension	Miktar/Qty.
1	427136	Kaliper Ayar Civatası / Caliper Calibration Bolt		1

Tip / Application

SBS 2220 SERIES

SAF

427137

Mekanizma Pleyti / Caliper Mechanism Plate

SAF Haldex Module T series

Orjinal No:

Cross No :



S.No.	Ekersan No.	Ürün Tanıtımı / Description	Ölçü/Dimension	Miktar/Qty.
1	427137	Mekanizma Pleyti / Caliper Mechanism Plate		1

Tip / Application

SBS 2220 SERIES

427140

Kaliper Mekanizma Tamir Takimi / Caliper Mechanism Repair Kit

SAF Haldex Module T series

Original No:

Cross No :



S.No.	Ekersan No.	Ürün Tanıtımı / Description	Ölçü/Dimension	Miktar/Qty.
1	428091	Sabitleme Plastik / Locking Plastic		1
2	423079	Ayar Dişli / Plastic Adjuster Gear		1
3	423076	Kaliper Tapası / Caliper Plug		1
4	423080	Plastik Tapa / Plastic Cap		1
5	423077	Kaliper Ayar Dişli / Caliper Adjusting Gear		1
6	428086	Kaliper Keçesi / Caliper Seal		1

Tip / Application

SBS 2220 SERIES